

**Getting Started with
AViiON[®] 7400 or 8500 Series
Systems**

014-002156-03

A V I I O N[®]
P R O D U C T L I N E

Notice

DATA GENERAL CORPORATION (DGC) HAS PREPARED THIS DOCUMENT FOR USE BY DGC PERSONNEL, CUSTOMERS, AND PROSPECTIVE CUSTOMERS. THE INFORMATION CONTAINED HEREIN SHALL NOT BE REPRODUCED IN WHOLE OR IN PART WITHOUT DGC'S PRIOR WRITTEN APPROVAL.

DGC reserves the right to make changes in specifications and other information contained in this document without prior notice, and the reader should in all cases consult DGC to determine whether any such changes have been made.

THE TERMS AND CONDITIONS GOVERNING THE SALE OF DGC HARDWARE PRODUCTS AND THE LICENSING OF DGC SOFTWARE CONSIST SOLELY OF THOSE SET FORTH IN THE WRITTEN CONTRACTS BETWEEN DGC AND ITS CUSTOMERS. NO REPRESENTATION OR OTHER AFFIRMATION OF FACT CONTAINED IN THIS DOCUMENT INCLUDING BUT NOT LIMITED TO STATEMENTS REGARDING CAPACITY, RESPONSE-TIME, SUITABILITY FOR USE OR PERFORMANCE OF PRODUCTS DESCRIBED HEREIN SHALL BE DEEMED TO BE A WARRANTY BY DGC FOR ANY PURPOSE, OR GIVE RISE TO ANY LIABILITY OF DGC WHATSOEVER.

IN NO EVENT SHALL DGC BE LIABLE FOR ANY INCIDENTAL, INDIRECT, SPECIAL OR CONSEQUENTIAL DAMAGES WHATSOEVER (INCLUDING BUT NOT LIMITED TO LOST PROFITS) ARISING OUT OF OR RELATED TO THIS DOCUMENT OR THE INFORMATION CONTAINED IN IT, EVEN IF DGC HAS BEEN ADVISED, KNEW OR SHOULD HAVE KNOWN OF THE POSSIBILITY OF SUCH DAMAGES.

AV Object Office, AV Office, AViON, CEO, DASHER, DATAPREP, DESKTOP GENERATION, ECLIPSE, ECLIPSE MV/4000, ECLIPSE MV/6000, ECLIPSE MV/8000, GENAP, INFOS, microNOVA, NOVA, OpenMAC, PRESENT, PROXL, SWAT, TRENDVIEW, and WALKABOUT are U.S. registered trademarks of Data General Corporation; and AOSMAGIC, AOS/VSMAGIC, AROSE/PC, ArrayPlus, AV Image, AV Imagizer Toolkit, AV SysScope, BaseLink, BusiGEN, BusiPEN, BusiTEXT, CEO Connection, CEO Connection/LAN, CEO Drawing Board, CEO DXA, CEO Light, CEO MAILI, CEO Object Office, CEO PXA, CEO Wordview, CEOwrite, CLARiiON, COBOL/SMART, COMPUCALC, CSMAGIC, DATA GENERAL/One, DESKTOP/UX, DG/500, DG/AROSE, DGConnect, DG/DBUS, DG/Fontstyles, DG/GATE, DG/GEO, DG/HEO, DG/L, DG/LIBRARY, DG/UX, DG/XAP, ECLIPSE MV/1000, ECLIPSE MV/1400, ECLIPSE MV/2000, ECLIPSE MV/2500, ECLIPSE MV/3200, ECLIPSE MV/3500, ECLIPSE MV/3600, ECLIPSE MV/5000, ECLIPSE MV/5500, ECLIPSE MV/5600, ECLIPSE MV/7800, ECLIPSE MV/9300, ECLIPSE MV/9500, ECLIPSE MV/9600, ECLIPSE MV/10000, ECLIPSE MV/15000, ECLIPSE MV/18000, ECLIPSE MV/20000, ECLIPSE MV/30000, ECLIPSE MV/35000, ECLIPSE MV/40000, ECLIPSE MV/60000, FORMA-TEXT, GATEKEEPER, GDC/1000, GDC/2400, Intellibook, microECLIPSE, microMV, MV/UX, OpStar, PC Liaison, RASS, REV-UP, SLATE, SPARE MAIL, SUPPORT MANAGER, TEO, TEO/3D, TEO/Electronics, TURBO/4, UNITE, and XODIAC are trademarks of Data General Corporation. AV/Alert is a service mark of Data General Corporation.

UNIX is a U.S. registered trademark of Unix System Laboratories, Inc.

All other trademarks mentioned herein are the property of their respective owners.

Getting Started with AViON® 7400 or 8500 Series Systems
014-002156-03

Revision History:

Original Release – March 1993
First Release – April 1993
Second Revision – August 1993
Third Revision – November 1994

How and when to use this document

This document provides brief, step-by-step instructions for setting up and starting your AViiON® 7400 or 8500 computer for the first time. The steps in this document will help you to quickly install a base system and verify that your computer arrived in working order. If your computer is preloaded with the DG/UX system, this document will help you install a default operating system at first powerup.

If you are not familiar with AViiON hardware, if you prefer detailed instructions, or if you have system options not covered in this document, we recommend that you use the more detailed *Installing and Operating* manual for your system.

Related documentation

The following manuals are the primary references for your system hardware. They provide all the information most users need, including more detailed versions of the procedures outlined in this document.

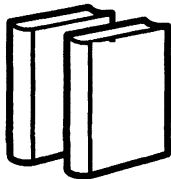

- *Installing and Operating AViiON® 7400 Series Systems* (DGC number 014-002176)
- *Installing and Operating AViiON® 8500 Series Systems* (DGC number 014-002247)
- *Installing the DG/UX™ System* (DGC number 093-701087)
- *Using AViiON® Diagnostics and the AV/Alertsm Diagnostic Support System* (DGC number 014-002183)
- *Installing and Maintaining a CLARiiON® Series 2000 Disk-Array Storage System — DG/UX™, AOS/VS II, or AOS/VS Environment, Deskside Model 2200 or 2300* (DGC number 014-002320)
- *Installing and Maintaining a CLARiiON® Series 2000 Disk-Storage System — DG/UX™, AOS/VS II, or AOS/VS Environment, Rackmount Model 2200 or 2300* (DGC number 014-002321)
- *Installing and Maintaining a CLARiiON® Series 1000 Disk-Array Storage system — DG/UX™, AOS/VS II, or AOS/VS Environment, Deskside Model 1100 or 1300* (DGC number 014-002338)

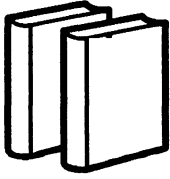

- *Installing and Maintaining a CLARiiON® Series 1000 Disk-Storage System — DG/UX™, AOS/VS II, or AOS/VS Environment, Rackmount Model 1100 or 1300* (DGC number 014-002339)
- *Installing, Operating, and Maintaining the CLARiiON™ Tape-Array-Storage System Model 7931 – DG/UX™ or AOS/VS II Environment* (DGC number 014-002359)
- *Setting Up and Installing VMEbus Options in AViiON® Systems* (DGC number 014-001867)
- *Setting Up SCSI Bus Configurations in the AViiON® Environment* (DGC number 014-002372)
- *Guide to AViiON® and DG/UX™ System Documentation* (DGC number 069-701085)

The *Guide to AViiON® and DG/UX™ System Documentation* describes all the documentation available for your computer system.

Telephone assistance



If you are unable to solve a problem using any manual you received with your system, free telephone assistance is available with your hardware warranty and with most Data General software service options.

If you are within the United States or Canada, contact the Data General Customer Support Center (CSC) by calling 1-800-DG-HELPS. Lines are open from 8:00 a.m. to 5:00 p.m. (all time zones), Monday through Friday. The center will put you in touch with a member of Data General's telephone assistance staff who can answer your questions.

For telephone assistance outside the United States or Canada, ask your Data General sales representative for the appropriate telephone number.

1

Verify your site requirements

- ✓ Do not begin until you ensure your site meets the following requirements:
 - Access to separate ac electrical outlets for the computer, system console, and AV/AlertSM modem.
 - Separate 15-ampere electrical circuit and enough outlets for CLARiiON[®] storage systems and other on-site peripherals.
 - Phone line reserved for AV/Alert use *only*.
 - Cleared work surface for console, keyboard, and other external peripherals; adequate floor space for computer and cables.

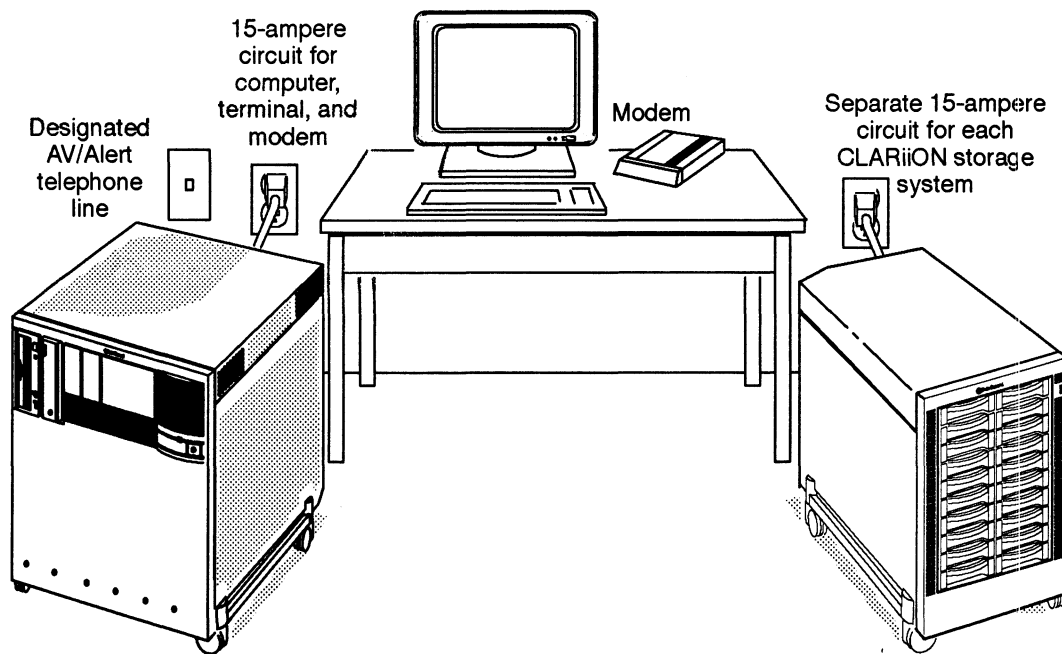

2

Unpack your equipment

- First, unpack the carton containing the computer unit.

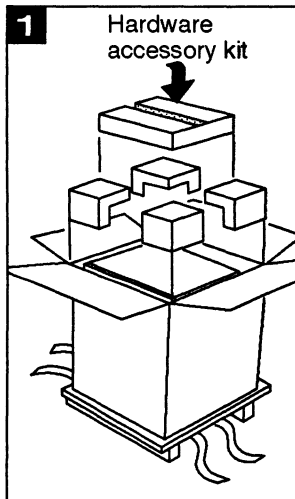

◆ Remove the outer strapping and open the top of the carton. Remove the packing corners and the hardware accessory kit from the carton. Set the accessory kit aside in a convenient place; it contains hardware and diagnostics documentation, standard system cables, a cable labeling kit, and cable dressing straps.

◆ Lift the outer carton up and away from the computer unit.

◆ Take care to provide enough clearance to lower the wooden ramp safely to the floor.

◆ Release the ramp from the computer unit, and lower it gently to the floor.

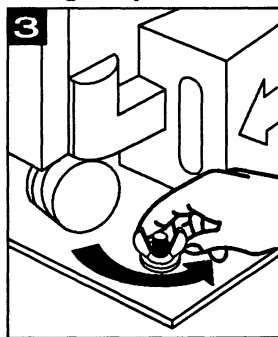
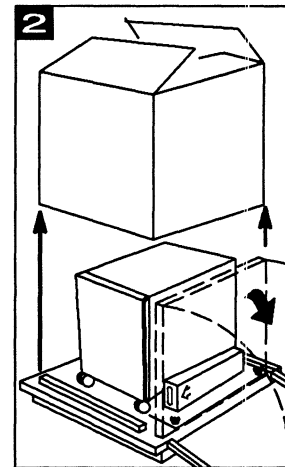

◆ Remove the two wing nuts and carriage bolts that hold the stabilizing foam under the ramp side of the computer to the pallet.

◆ Grip the piece of foam by the notched handle, and pull the foam from under the computer unit. Gently pull the unit toward the ramp and onto its casters.

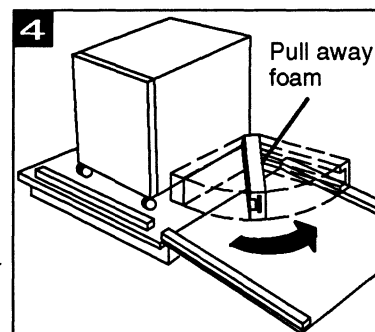

Unpack all your equipment

Continued

- ▶ Roll the computer down the ramp.

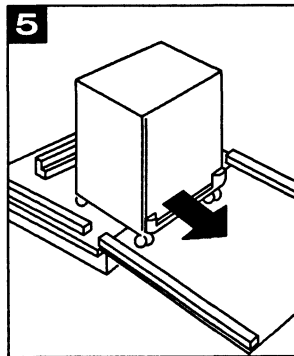

◆ Adjust the ramp so it meets the pallet surface evenly. Carefully roll the computer unit down the ramp onto the floor.

- ▶ Remove the pallet and packing material from your installation site, and proceed to unpack the remainder of your shipment. Remember to keep the hardware accessory kit near your computer unit; you will need its contents to complete your installation.
- ▶ Unpack the console and any peripheral options you received, such as
 - CLARiiON storage system
 - Uninterruptible Power Supply (UPS)
 - Peripheral Housing Unit (PHU) or Combined Storage Subsystem (CSS)
 - LAN transceiver
 - Network asynchronous package
 - Printer

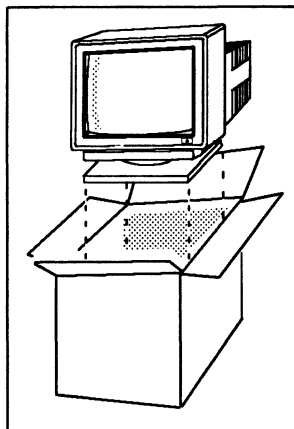

Unpack all your equipment

Continued

- ▶ Unpack the hardware accessory kit.

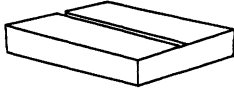

The hardware accessory kit (a small, flat box packed inside the computer unit carton) contains the following:

- Console cable (005–34xxx).
- Cable label/map kit (005–40407).
- Ethernet LAN cable (007–6253).
- Computer unit power cord (109–xxx).
- Pair of Velcro cable ties (118–15306).
- Hardware documentation pack (005–40605).
- Release Notice and any diagnostic media.

Note that your console cable and computer unit power cord part numbers will vary depending on your order. See the cable checklist in Step 3.

- ▶ Unpack the overpack box.

The overpack box contains the following:

- AV/Alert modem kit (sites in the U.S. and Canada only) (005–39946), which includes
 - Exterior asynchronous cable (005–36257).
 - Asynchronous gender-conversion cable (005–38420).
 - Modem (119–3097).
- SCSI cables.
- SCSI adapter cable (005–39975).
- Miscellaneous cables for other peripherals.

Unpack all your equipment

Continued

- ▶ Unpack any other boxes.

An auxiliary carton (called the documentation box) either may be included in your overpack box, or may be shipped separately. This box contains other documentation you need to support your order.

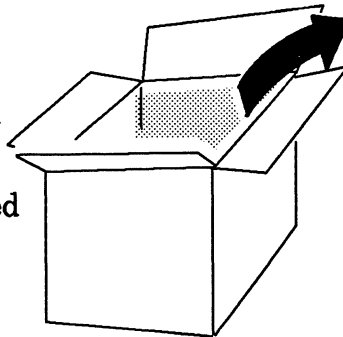

- Software and peripherals documentation.
- Software diagnostic media and Release Notice.
- Additional items you won't need now, but may need for upgrading or maintaining your system.

✓ Check when completed:

- All equipment inspected for damage.
- Packing slips match Sales Order document.

3

Inventory your cables

- Use this check list to inventory your cables and check them against the packing slip.

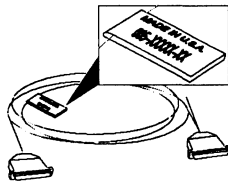

DB25 male to DB25 male

System console and other asynchronous terminals

	Length	Cable type	Part number	Model number
<input type="checkbox"/>	10-ft	EIA RS-232	005-34256	15340E010
<input type="checkbox"/>	15-ft	EIA RS-232	005-34990	15340E015
<input type="checkbox"/>	25-ft	EIA RS-232	005-34991	15340E025
<input type="checkbox"/>	50-ft	EIA RS-232	005-37141	15340E050

AV/Alert and other asynchronous modems

	Length	Cable type	Part number	Model number
<input type="checkbox"/>	10-ft	EIA RS-232	005-36256	15369E010
<input type="checkbox"/>	15-ft	EIA RS-232	005-36257	15369E015
<input type="checkbox"/>	25-ft	EIA RS-232	005-36258	15369E025

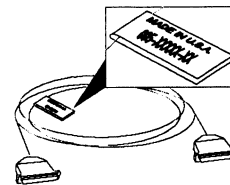

DB25 male to DB25 male

Ethernet LAN

- 10-ft flexible drop cable (white) part number 007-6253

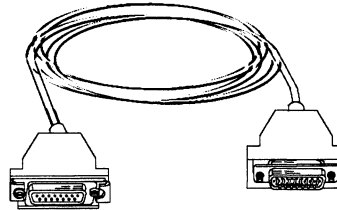

15-pin with slide clip connectors

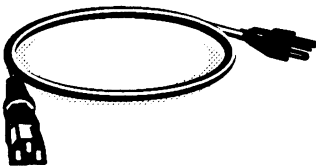

ac power

Country	Part number	Country	Part number
<input type="checkbox"/> US, Canada	109-719	<input type="checkbox"/> Europe, except:	109-884
<input type="checkbox"/> United Kingdom	109-886	<input type="checkbox"/> Italy	109-883
<input type="checkbox"/> Australia	109-885	<input type="checkbox"/> Denmark	109-849
		<input type="checkbox"/> Switzerland	109-848

Inventory your cables

Continued

External SCSI devices (single-ended and differential)

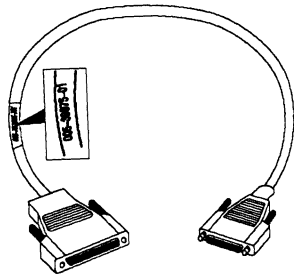

	Length	Cable type	Part number	Model number
<input type="checkbox"/>	2.5-ft	wide-to-narrow adapter	005-39975	E79534

68-pin male P&S to 50-pin female P&S

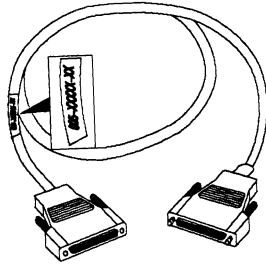

	Length	Cable type	Part number	Model number
<input type="checkbox"/>	10-ft	wide SCSI bus	005-40003	15418E010
<input type="checkbox"/>	20-ft	wide SCSI bus	005-40004	15418E020
<input type="checkbox"/>	40-ft	wide SCSI bus	005-40005	15418E040

68-pin male P&S to 68-pin male P&S

4

Connect your system console

✓ Make sure you have the following:

- A small, flat-blade screwdriver (non-magnetic).



- Cleared final location for console, keyboard, and desktop peripherals.
- Adequate floor space for computer, cables, and deskside peripherals.
- Documentation for hardware options and peripherals. Also, most installers will need the *Installing the DG/UX™ System* manual and the DG/UX Release Notice.

▶ Set the system console characteristics.

System console characteristics

Refer to the instructions that accompanied your console.

A system console for an AViiON system requires:

9600 baud
8 data bits
NO parity
ANSI character set
Enabled flow control

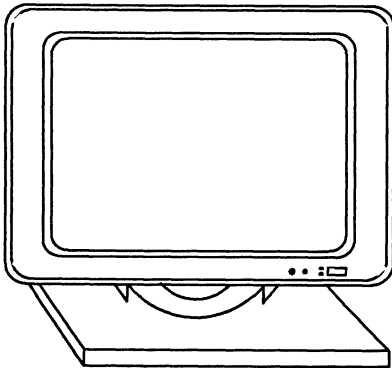

A system console shared by an AViiON system and a CLARiiON storage system requires:

9600 baud
8 data bits
EVEN parity
ANSI character set
Enabled flow control

Connect your system console

Continued

- ▶ Attach the console's keyboard and power cord.

Connect the power cord.
(Other end goes to grounded
ac outlet.)

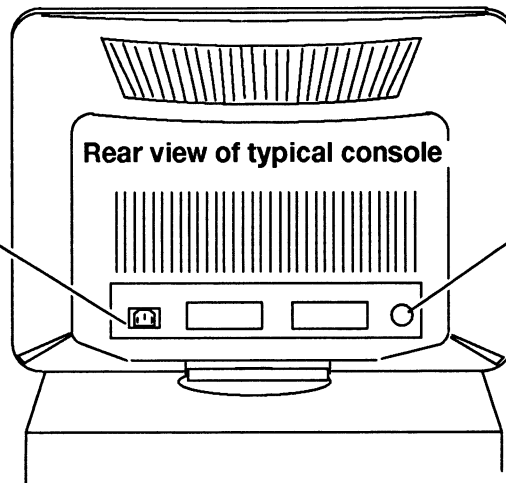
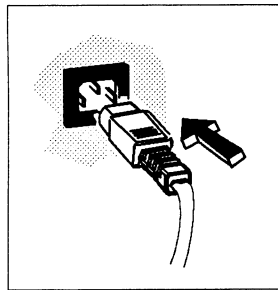

Connect the
keyboard.

- ▶ Attach the system console power cord to a grounded ac power outlet.

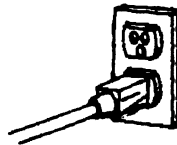

Connect your system console

Continued

- ▶ Attach the system console to the OP CON port connector found on the I/O controller board located in slot 8 using one of the following cables: 005-34256, 005-34990, 005-034991, or 005-37141.

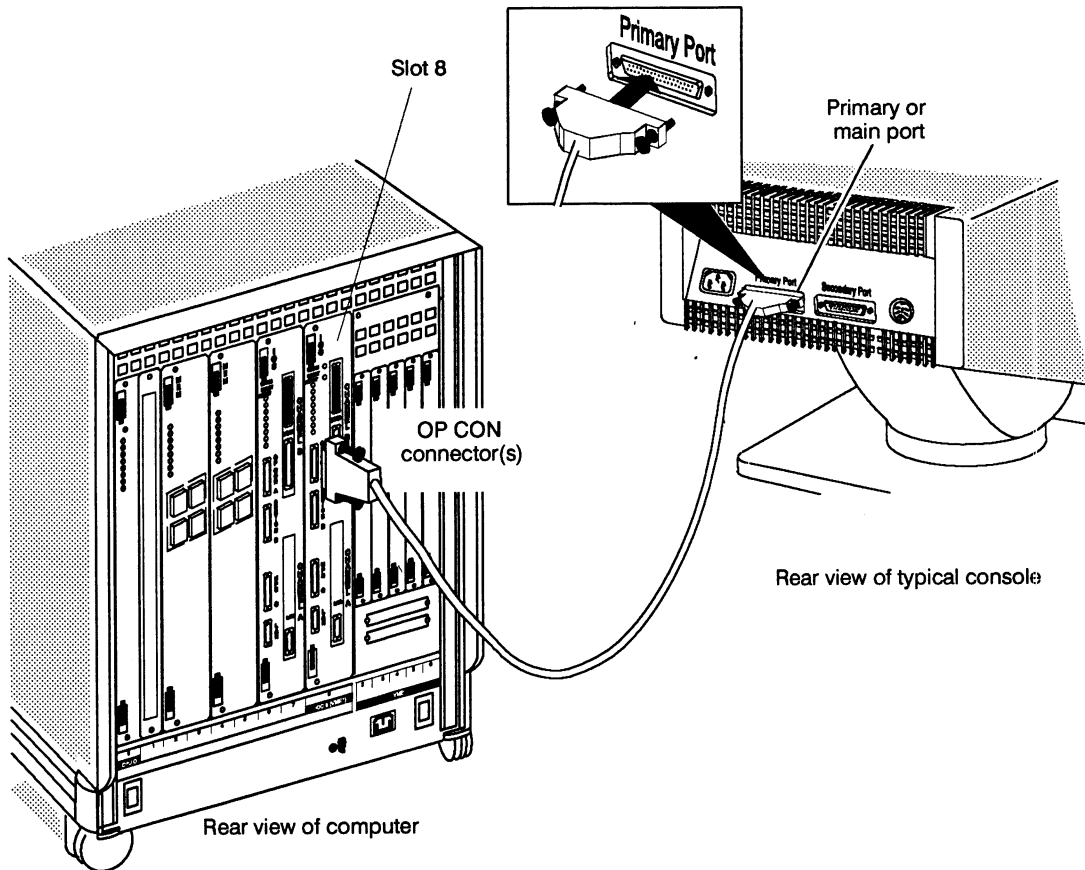

- ▶ If a CLARiiON disk-array storage system shares a system console with your AViiON computer, refer to your CLARiiON documentation to connect the storage system to your console.

Connect your system console

Continued

- ▶ If you have two I/O controllers and want them to share a system console in a high-availability configuration, attach the RS-232-A port in slot 6 to your system console's secondary connector with an asynchronous terminal cable and any necessary adapters.

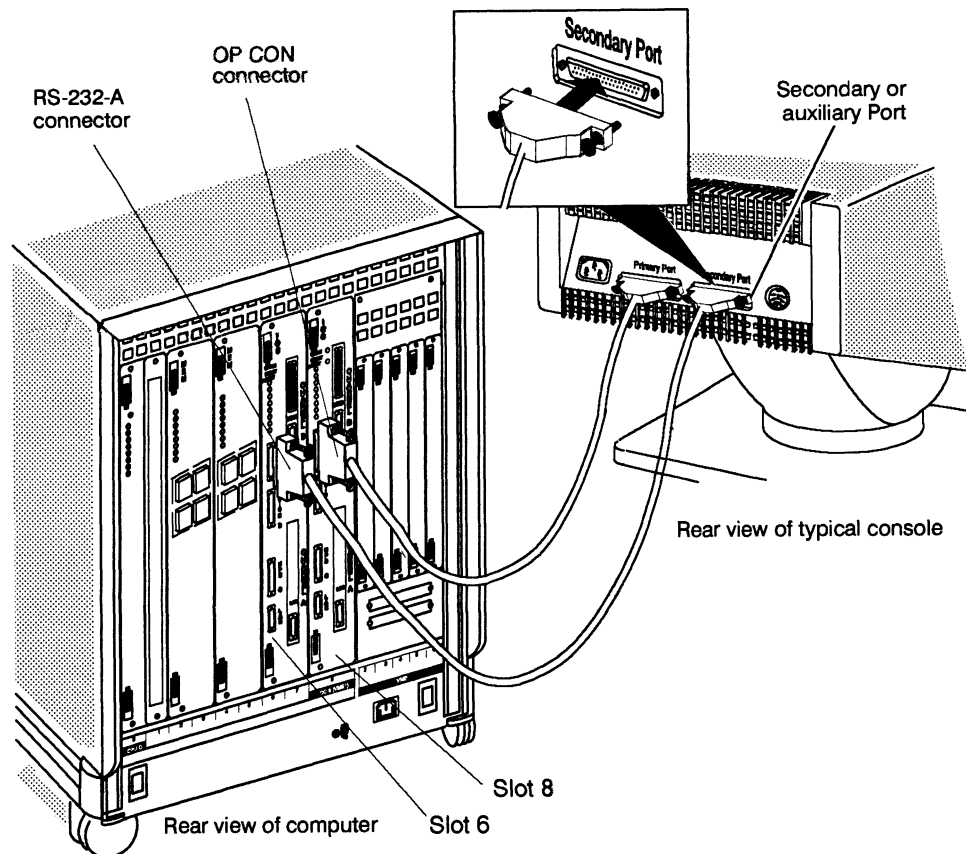

IMPORTANT: If you have a 9-pin console port, you may need adapter cable 005-3315.

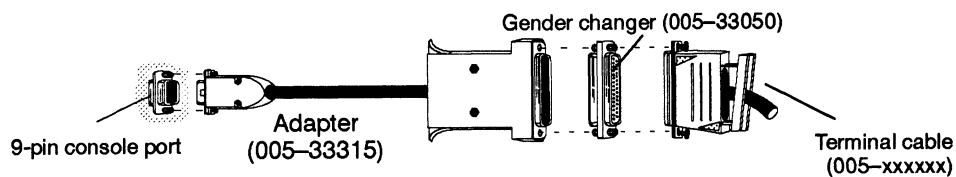

5

Connect your AV/Alert modem

- ▶ Attach your AV/Alert modem to the SERVICE port in slot 8 using cable 005-36257.

Refer to your modem document and *Using AViiON® Diagnostics and the AV/AlertSM Diagnostic Support System* for detailed installation instructions.

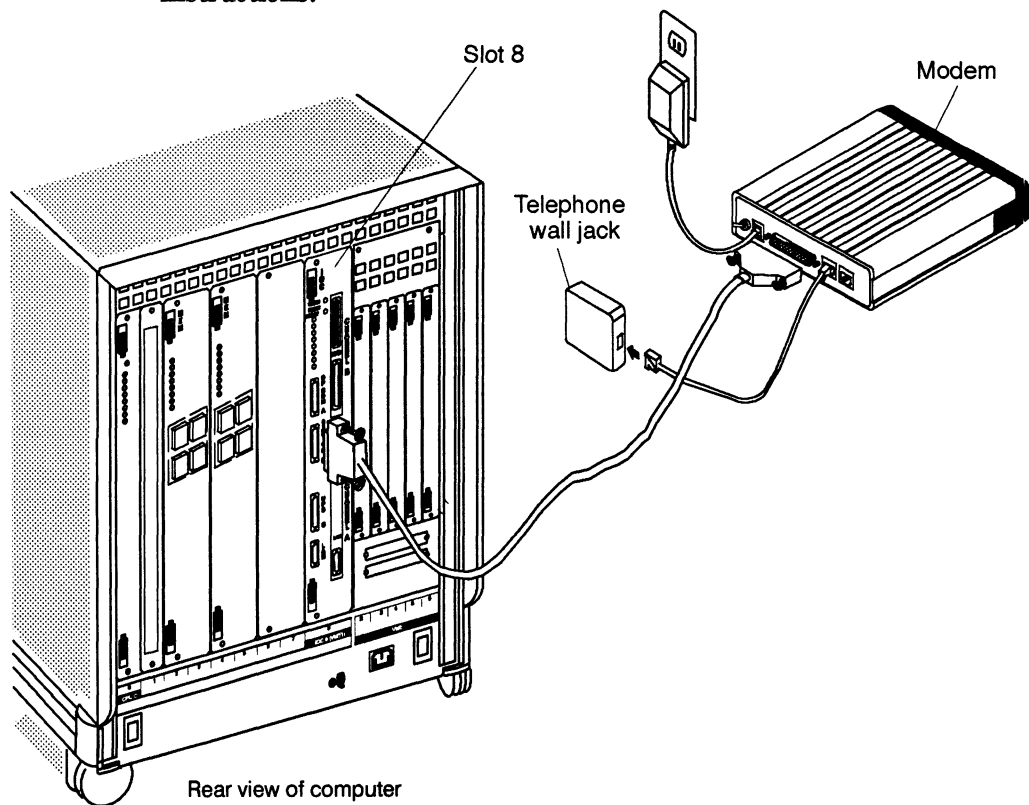

6 Connect your uninterruptible power supply (UPS)

- ▶ Attach your uninterruptible power supply (UPS) to the UPS port in slot 8. For more detailed instructions, refer to the documentation that ships with the device you are connecting.

IMPORTANT: Be sure to use the special cable that ships with the UPS to connect to the UPS port on the IOC.

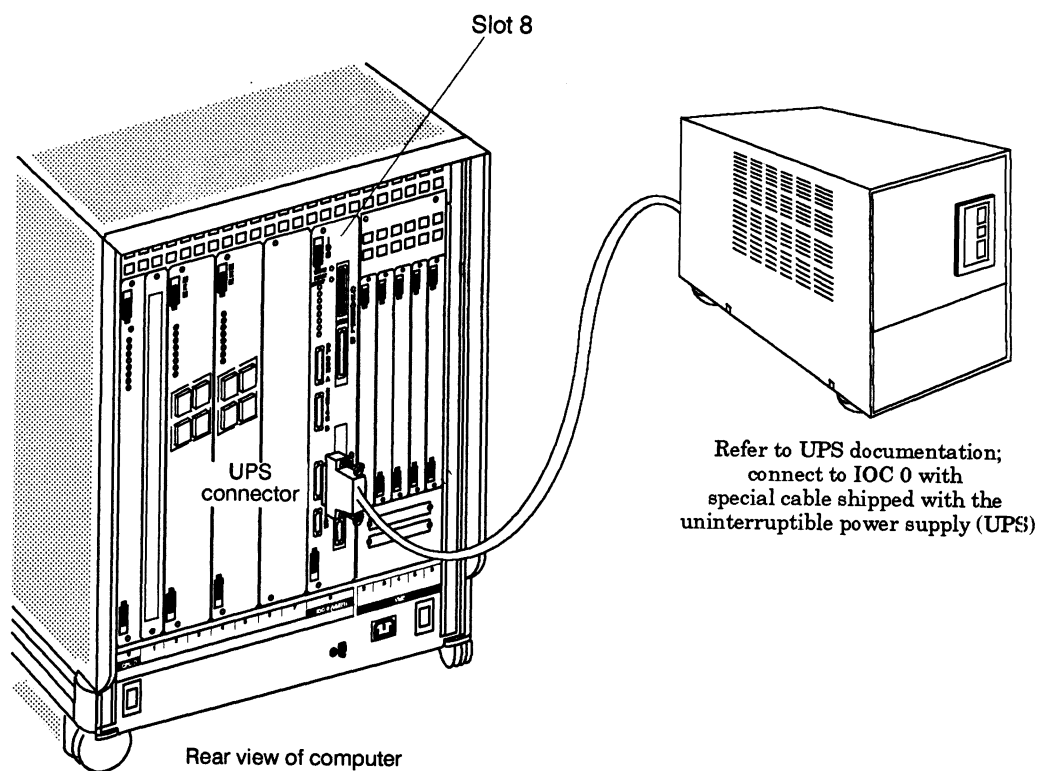

7

Connect your integrated Ethernet LAN

- ▶ Attach your first local area network (LAN) to the LAN port in slot 8 using the 10-foot, flexible drop cable (part number 007-6253). For more detailed instructions, refer to your Ethernet LAN installation documentation. If you have a second LAN, connect it to the LAN port in slot 6.

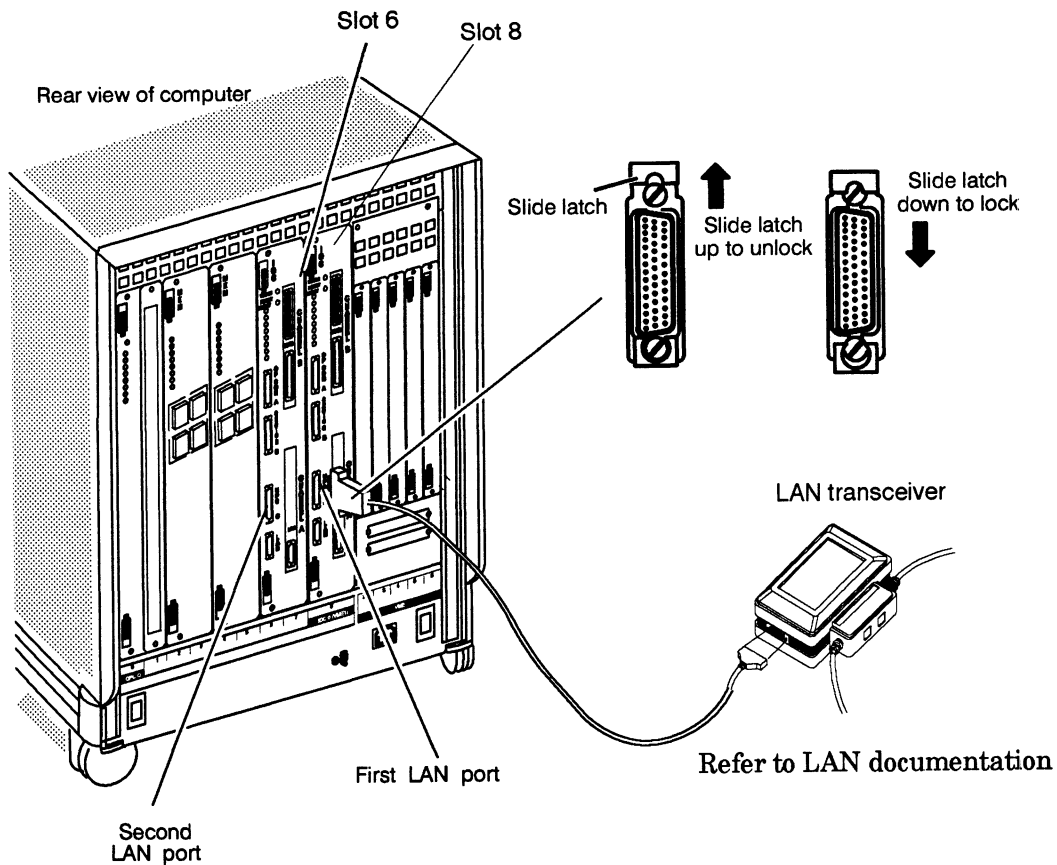

- ▶ To set up a multipath disk and LAN for high availability/ failover, refer to the *Installing and Operating* manual for your computer model and the *High Availability* manual that ships with the DG/UX system.

8

Connect remaining asynchronous devices

- ▶ Attach your printers, scanners, or any other remaining asynchronous devices to the RS-232 ports in slot 6, using the appropriate asynchronous cables. For more detailed instructions, refer to the documentation that ships with the device you are connecting.

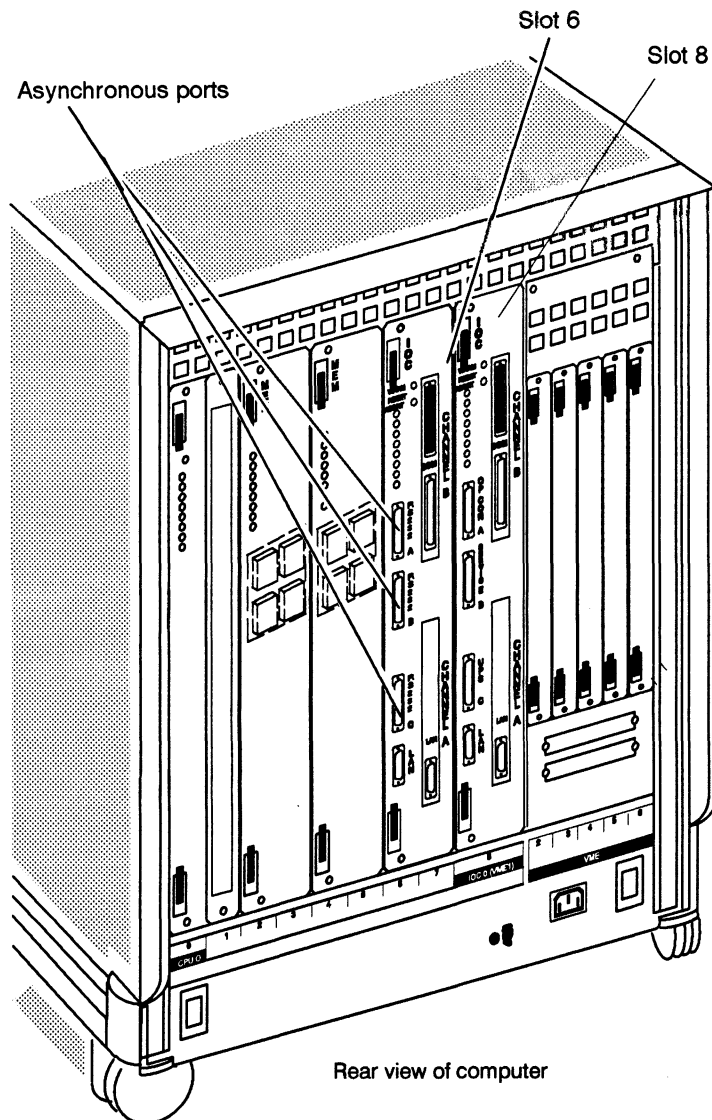

9

Connect CLARiiON storage systems

- ▶ Attach any CLARiiON disk-array or tape-array storage systems to the SCSI ports in slot 8, using single-ended or differential SCSI cables. Refer to the CLARiiON documentation for detailed instructions.

CLARiiON Storage Systems

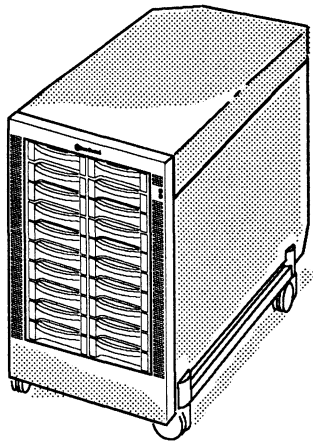

Series 2000 disk-array storage system

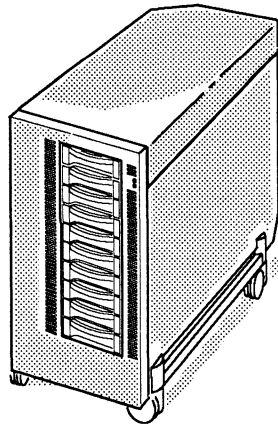

Series 1000 disk-array storage system

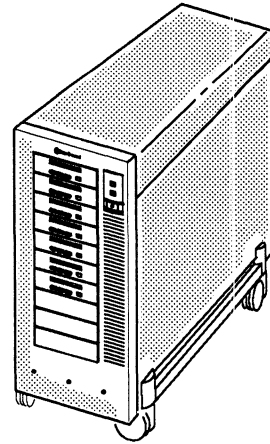

Series 4000 tape-array storage system

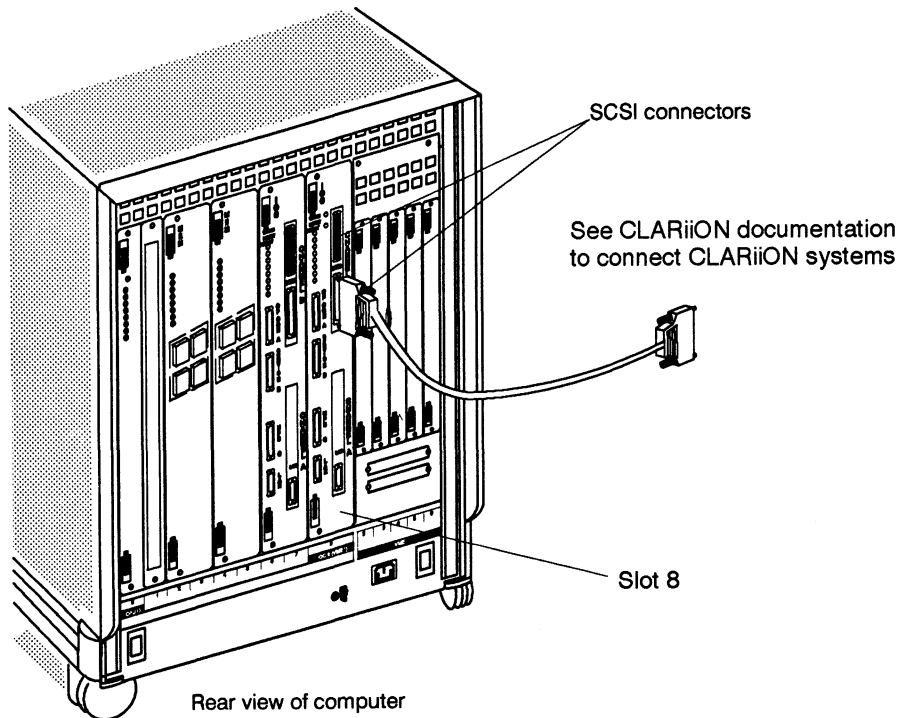

10 Connect other SCSI-based mass-storage devices

- ▶ If you do *not* have a CLARiiON storage system, use the SCSI ports in slot 8 and single-ended or differential SCSI cables to connect any other SCSI-based mass-storage device, such as a combined storage subsystem (CSS), peripheral housing unit (PHU), or stand-alone device. For more detailed instructions, refer to *Setting Up SCSI Bus Configurations in the AViiON® Environment*.
- ▶ If you already cabled the SCSI ports in slot 8, use the SCSI ports in slot 7 to connect additional SCSI-based mass-storage devices.

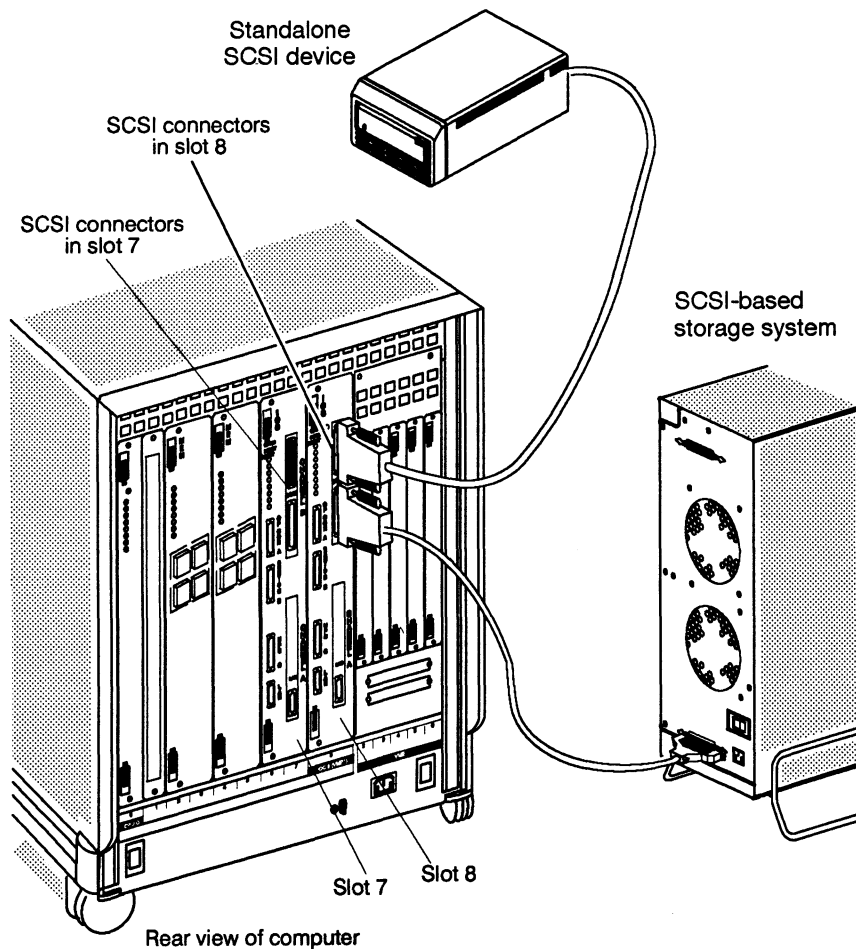

11 Connect devices to the VMEbus

- ▶ Refer to *Setting Up and Installing VMEbus Options in AViiON® Systems* (014-001867) to connect devices to the VMEbus option boards.

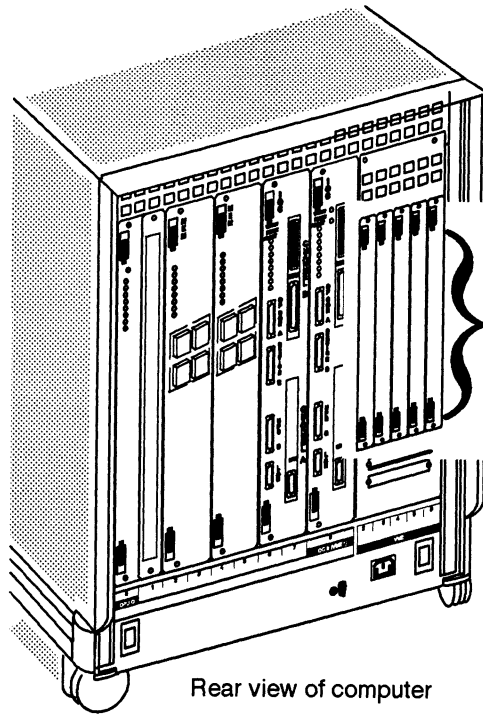

Rear view of computer

To connect devices to VMEbus option boards, refer to *Setting Up and Installing VMEbus Options in AViiON® Systems*.



12 Determine if your system is preloaded

- ▶ Look at your packing slip to see if the DG/UX operating system was shipped with your order.

IMPORTANT: If the DG/UX operating system shipped with your order, it will come preloaded on your computer (installed at the factory).

If your system is preloaded

If your system is preloaded and you are familiar with AViiON system hardware and the DG/UX operating system, the startup information in this document may be sufficient to complete your first system startup. If you feel confident that you won't need additional help, begin with the installation procedures for the operating system in the next section.

If you are new to AViiON systems, or if you would like more detailed information and step-by-step instructions, refer to *Installing the DG/UX™ System*.

If your system is not preloaded

If your system is not preloaded, you can power up now and run diagnostics only, or if you want to install the operating system now, you can refer to *Installing the DG/UX™ System*.

- ▶ Refer to the following flowchart to decide how you should proceed.

Determine if your system is preloaded

Continued

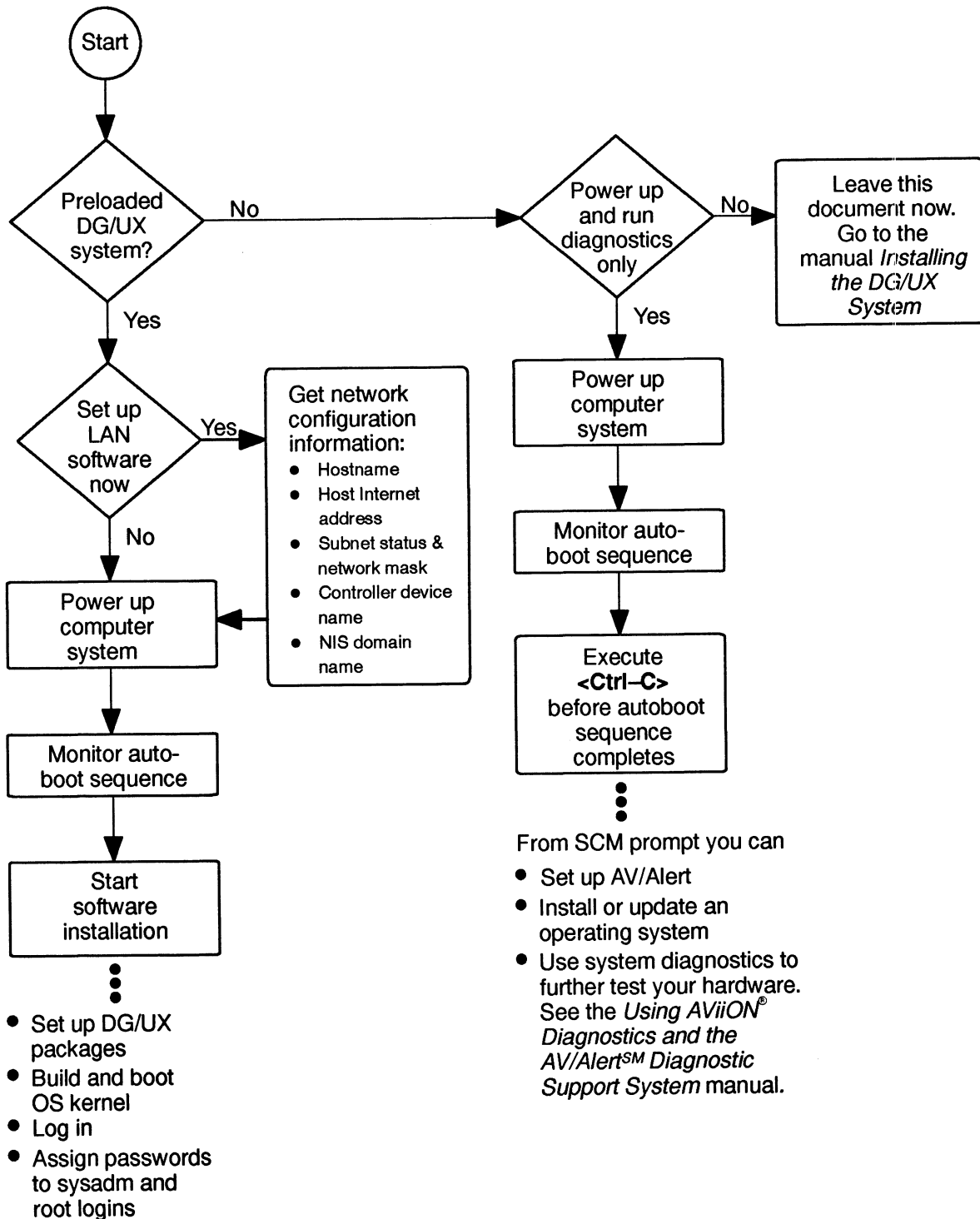

► If you are ready to power up now, proceed to the next section.

13 Prepare to install the operating system

The startup procedures outlined in the remainder of this document assume the DG/UX system was loaded on your system disk at the factory (preloaded). They further assume that you have either planned your DG/UX system, or do not intend to completely install your operating system and network(s) at this time.

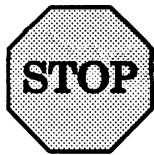

Powering on the computer begins an installation process that you cannot interrupt without risk of damaging files.

If your computer is preloaded, your AViiON system can be up and running within minutes. However, successful installation requires a moment of careful planning.

Before setting up the ONC and TCP/IP packages, you will need the following information:

- Hostname
- Host Internet address
- Subnet status and network mask
- LAN controller device name
- NIS domain name

Before setting up the Legato NetWorker™ package, you will need the following information:

- Whether your system is a NetWorker client or server.
- If your system is a NetWorker server, the name of the physical disk that holds the var_opt_networker virtual disk. (Do not specify a shared disk).
- The block size of the virtual disk.

The Planning Worksheet on the next page will help you organize your information.

Prepare to install the operating system

Continued

- Fill out the following Planning Worksheet for required DG/UX package information before you begin the software installation process.

Network Package Configuration Worksheet

Package Parameters	Example	Actual
Configure system as client of a remote NetWorker server?	NO	
NIS domain	WORKNET	
Name of host	MOE	
Host Internet address	128.224.1.2	
Do you subnet?	YES	
Network mask	0xffff00	
Controller device	dgen0	

14 Power up your computer system

- ▶ Turn on power to the system console and any other devices attached to the computer system, such as terminals, LAN-based devices, storage systems, and VMEbus options.

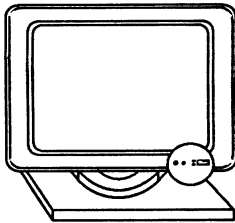

It is important to have *all* peripherals powered up and on line the first time you turn on the computer system. This enables the DG/UX operating system to recognize each device and AV/Alert to register your hardware for warranty and tracking purposes.

- ▶ Turn on power to your CLARiiON storage system(s).

CLARiiON Storage Systems

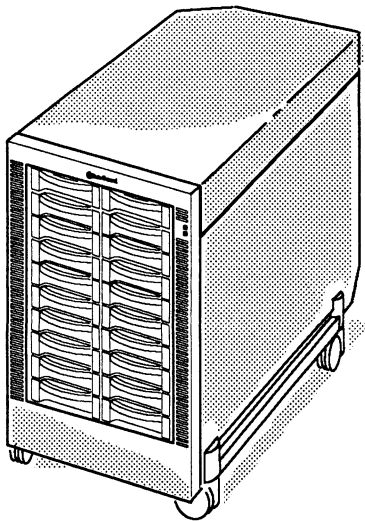

**Series 2000
Disk-Array
Storage System**

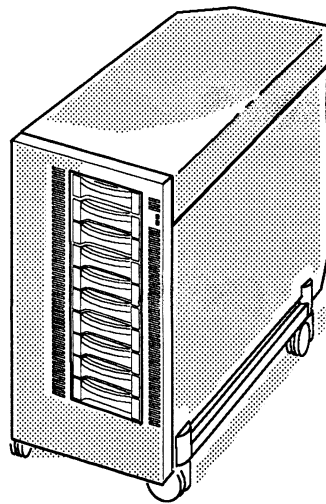

**Series 1000
Disk-Array
Storage System**

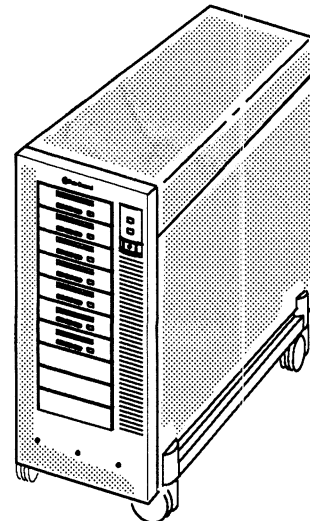

**Tape-Array
Storage System**

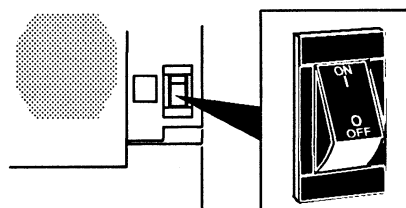

Power up your computer system

Continued

- ▶ Verify that the power cord is connected to your computer and plugged into a wall outlet, and then turn on power to the computer. Watch for the green LED to illuminate. It may take about a minute before messages appear on your console display.

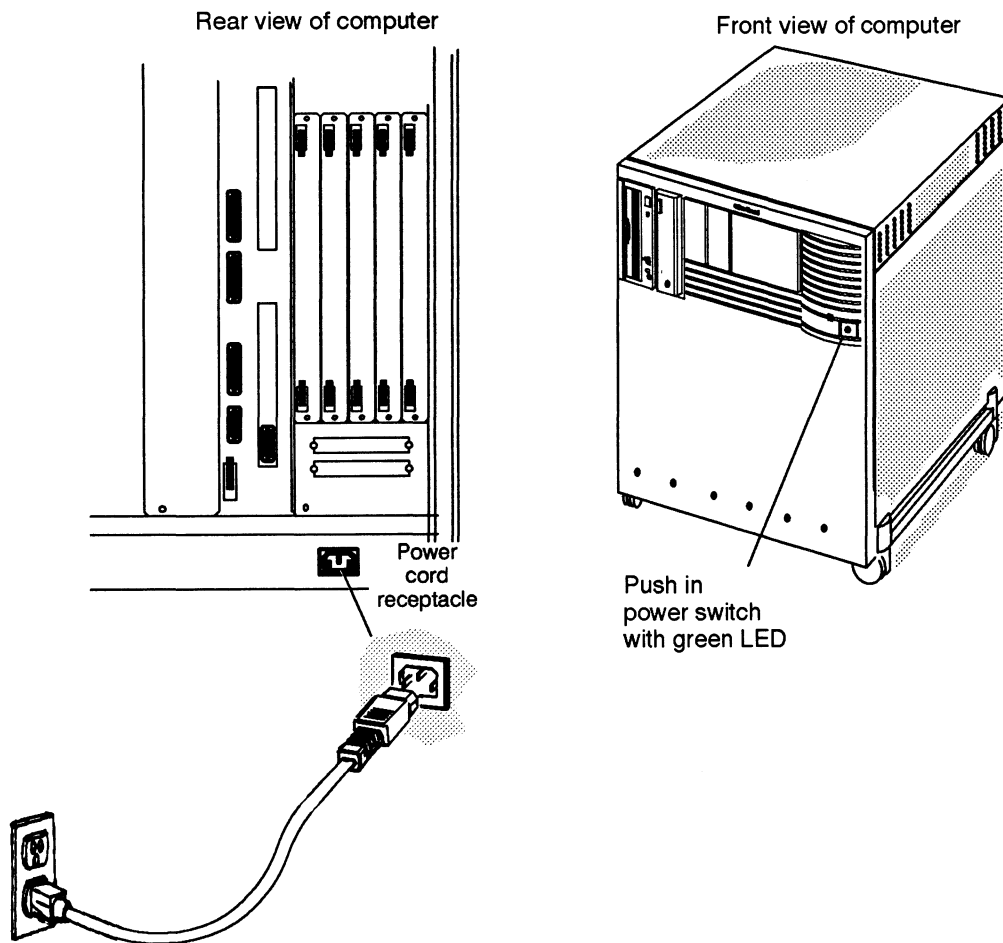

15 Monitor the automatic boot sequence

- ▶ Watch the screen display carefully during the automatic boot sequence. It reports information about your hardware configuration.

IMPORTANT: If you've set up the AV/Alert modem, you may notice it making registration calls during your first powerup. AV/Alert automated calls are toll-free.

Sample screen display during automatic boot sequence

```
Sizing system
CPU board in slot 0
MM board in slot 2
IOC board in slot 8
Found SIMM A (32M) in slot 2
Found SIMM B (32M) in slot 2
Found SIMM C (32M) in slot 2
Found SIMM D (32M) in slot 2

Initializing Caches.....
Initializing memory starting at 0x0; ending at
0x7FFFFFC

Sizing for expansion devices on IOC0...
Found on-board SCSI
Found on-board LAN
Found VME
Found expansion 0 LAN
Found expansion 1 SCSI A
Found expansion 1 SCSI B
Testing memory access

Copyright Data General Corporation 1994
AViiON 7400/8500 Series Computer
Multi processor
Firmware Revision 0X.X
IOC0 Integrated LAN: Ethernet address is XX YY ZA BB CC DD
Initializing 128 Megabytes [128]
Testing...
0123456789ABCDEFGHIJKLMNPOQRSTUVWXYZ
```

- ▶ Record your Ethernet address(es) for future use: _____
For example: XX:YY:ZA:BB:CC:DD

Monitor the automatic boot sequence

Continued

Sample screen display during autoboot sequence (continued)

```
Passed

Booting sd(ncsc(),3)

Unable to load boot file sd(ncsc(),3)
Booting st(ncsc(),4)

*** Check SCSI cabling, and check that tape is in drive.***
Unable to load boot file st(ncsc(),4)

Booting sd(ncsc(),0)root:/dgux.installer -i
```

Device specification for the boot device

- ▶ Record the device specification for your boot device: _____
For example: sd(ncsc(),0)
- ▶ Continue or interrupt the software installation procedure. The following descriptions explain your options.

If you do not want to install preloaded software now

If you do *not* want to begin the software installation and bring up DG/UX at this powerup, you must execute the **<Ctrl-C>** sequence from your system console keyboard before the autoboot sequence completes. (Do not enter **<Ctrl-C>** until *after* your system passes powerup diagnostics and displays the message *Passed*.) Exiting the autoboot before it completes will bring your system to the System Control Monitor (SCM) prompt as though it did not include preloaded DG/UX.

Monitor the automatic boot sequence

Continued

Stopping the operating system installation

```
Passed

Booting sd(ncsc(),3)

Unable to load boot file sd(ncsc(),3)

Booting st(ncsc(),4)

*** Check SCSI cabling, and check that tape is in drive.***
Unable to load boot file st(ncsc(),4)

Booting sd(ncsc(),0)root:/dgux.installer -i
Unable to load boot file sd(ncsc(),0)root:/dgux.installer -i

Jp#0/SCM>
```

From the SCM prompt, you can

- Set up, activate, and verify AV/Alert. Refer to *Using AViiON® Diagnostics and the AV/AlertSM Support System*.
- Use AViiON System Diagnostics to further test your system hardware. Refer to *Using AViiON® Diagnostics and the AV/AlertSM Support System*.
- Install or update an operating system. Refer to *Installing the DG/UX™ System* and the Release Notices that accompanied your software.

If you do want to install preloaded software now

If you *do* want to begin the software installation at this time, allow the autoboot sequence to complete by responding to the system prompts for input.

Monitor the automatic boot sequence

Continued

Continuing with the operating system installation

```
Booting sd(ncsc(),0)root:/dgux.installer -i
DG/UX System Release 5.4R3.10, Bootstrap
Loading image.....
DG/UX System Release 5.4R3.10, Version Installer
Using 128 Megabytes of physical memory
Found 2 processor(s)
Configuring devices.....

Do you want to configure any nonstandard devices? [no]
```

The system asks if you want to configure any nonstandard devices. A *nonstandard device* is one you purchased from a different vendor and that is not recognized by the DG/UX system. If you do need to configure nonstandard devices, answer **yes** to the prompt and refer to *Installing the DG/UX™ System* before continuing. If you do not, just answer **no**, and continue following the on-line prompts.

You can set up software packages, build and boot a default system kernel, and bring your system to DG/UX init level 3 in a few minutes by simply accepting default values whenever a screen display asks for your input.

- ▶ When you are ready to select which software packages to set up, proceed to the next section.

16 Set up software packages

The files for the software packages were loaded on your system at the factory. The DG/UX Installer program prompts you to select which software packages you want to set up. (See the *Installing the DG/UX™ System* manual for a description of each software package.)

- ▶ Start the package setup dialog by pressing Enter at the initial prompt.

```
Set up packages? [yes] ↵
```

- ▶ Select DG/UX packages to set up.

If you are sure you want to set up *all* DG/UX packages now, simply press Enter at the prompt to accept the default [all], and skip ahead to Step 17.

```
Package Name(s): [all] ↵
```

To view the package list and select individual packages, type a question mark (?) at the prompt, and press Enter.

```
Package Name(s): [all] ? ↵
```

A screen similar to the following appears:

Select software packages to set up

Continued

Select 'all' to load all packages from the release medium. If there are specific packages that you want to load, you may select the package names. Separate the package names or numbers with commas.

Do not select 'all' if you are selecting individual packages.

Choices are

- 1 all
- 2 dgux
- 3 gcc
- 4 networker
- 5 nfs
- 6 onc
- 7 tcpip
- 8 X11
- 9 X11.sde
- 10 xdt
- 11 dgux.man
- 12 gcc.man
- 13 tcpip.man
- 14 nfs.man

...next page? (? for help) [yes] ↓

Press Enter at the Page prompt to display the full menu.

- 15 onc.man
- 16 networker.man
- 17 xdt.man
- 18 X11.man
- 19 X11.sde.man

Enter a number, a range of numbers (n-m, where m can be '\$' to indicate the last item), a name, the initial part of a name, <NL> to take the default, ? for help, ^ to return to the previous query, < to restart the operation, or q to quit.

Package Name(s): [all]

- Specify individual packages by typing the full name or corresponding number, as listed in the screen menu.

Separate each package name or number by commas or spaces. You also may use a dash to specify a range of package numbers; for example, 2-3,9-11.

IMPORTANT: You must select the Gnu C Compiler (**gcc**) package. Without **gcc**, you will not be able to create subsequent operating system kernels.

Select software packages to set up

Continued

Select packages with a **.man** extension for on-line viewing or printing of **man** pages. Manual pages are not shipped in hard-copy form.

For example, if you wanted to install the DG/UX, GCC, NFS, ONC, TCP/IP, X11, X11.sde, and XDT packages and their man pages, after the prompt, you might type the following:

```
Package Name(s): [all] 2,3,nfs,onc,tcpip,8-15,17-19 ↵
```

The system will ask you to verify your selections. If you make a mistake or change your mind, you can go back and repeat the selection process.

- ▶ When you are satisfied with your selections, press Enter after the prompt to begin the setup process.

```
OK to perform operation? [yes] ↵
```

- ▶ Follow the on-line messages.

The Installer program sets up most of the software packages without interaction, although the system displays progress messages during setup and reports successful completion. The Installer program will set up the packages in the same order as they are displayed on the selection menu.

Setting up the DG/UX packages only (no network) takes about 8 minutes. It takes a bit longer to set up all the packages.

IMPORTANT: The NetWorker, NFS, ONC, and TCP/IP packages do require user input. Make sure you have the necessary information described in Step 13.

- ▶ What to do next.

The following sections provide specific information on answering questions for the NetWorker, NFS, ONC, and TCP/IP software packages. If you selected any of those packages, we recommend you read those sections. If you did not select any of those packages, you can proceed to the section on building and booting a configured kernel (Step 17).

Select software packages to set up

Continued

Setting up NetWorker

This section describes how to answer the prompts to set up the NetWorker software package.

Configuring as a Client or a Server

How the Installer program sets up NetWorker depends on whether you are setting up your system as a client that will back up its files to a remote NetWorker server or as a local-only NetWorker server that backs up its own files. You will see the following prompt.

```
Configure system as a client for a remote NetWorker
server? [no]
```

- If this host will back up files to a NetWorker server, type **yes** after the prompt and press enter.

If you answer yes to this prompt, there are no more NetWorker questions. The system will proceed to the next package you want to set up.

- If this host will back up its own files to tape (not to a remote NetWorker server) accept the no default to the prompt by pressing Enter.

When you answer no to the prompt, you need to allocate space for NetWorker index and log files.

Virtual Disk Requirements

Read the screen message about virtual disk requirements carefully:

```
You now have the opportunity to create or adjust the
size of the /var/opt/networker file system. This file
system is needed to store the NetWorker online index
and log files. The default size of 10000 blocks is
enough space to store index information for multiple
versions of several thousand files - about enough for a
small workstation with a single disk drive. THIS IS NOT
ENOUGH SPACE FOR A SERVER WITH REMOTE CLIENTS! If your
system has more than one disk drive, or if it will be
acting as a NetWorker server for remote clients, you
probably need to allocate additional space for the
online index. See the installing manual for
instructions on estimating the space requirements for
the online index.
```

Select software packages to set up

Continued

The Installer program displays default requirements for creating, sizing, and mounting the on-line index, and then prompts you to accept or modify the values:

```
/var/opt/networker File System

File System      Virtual      Current  Action  Blocks  Physical
Mount Point      Disk         Blocks  Required To Add  Disk
-----
/var/opt/networker var_opt_networker -      Create  10000  sd(ncsc(0),0,0)

Modify this information? [no]
```

Accepting the default values

To accept the values presented in the table, press **Enter** after the prompt.

If you accept the default values, the system displays the following messages:

```
Creating /dev/dsk/var_opt_networker (10000 blocks) on
sd(ncsc(0),00).
Virtual disk "var_opt_networker" created.
Virtual disk "var_opt_networker" made a volume.
Mounting /dev/dsk/var_opt_networker.
```

Modifying the default values

To modify any of the information in the table, type **yes** and press **enter** after the prompt.

When you answer **yes** to the prompt, the Installer program presents the following series of prompts to collect virtual disk information.

```
Mount a virtual disk at var/opt/networker? [yes]
```

- To accept the default mount point, press **Enter**.
- To enter an alternative mount point type **"no,"** and then enter the name of the mount point you want to use.

CAUTION: *If you intend to upgrade the NetWorker software to the next release at some future date, do not change the mount point. If you do, the DG/UX installation utility will not be able to locate the correct virtual disk to upgrade.*

Select software packages to set up

Continued

Virtual disk to mount at var/opt/networker:

[var_opt_networker]

- To accept the default name for the virtual disk to mount, press Enter.
- To change the name of the virtual disk to mount, enter the name of the virtual disk you want to use and press Enter.

IMPORTANT: If you changed the default mount point, the default virtual disk name is the name of the mount point.

Size (in blocks) for var_opt_networker: [10000]

- To accept the default value for the block size, press Enter.
- To change the value of the block size, enter the value you want to use after the prompt and press Enter. For example: **50000** ↵ . Remember, we had you collect this network information earlier and record it on the Planning Worksheet in Step 13.

Physical disk for var_opt_networker: [sd(ncsc(0),0,0)]

- To accept the default name of the physical disk that holds the virtual disk, press Enter.
- To change the physical disk, type the name of the drive you want to use after the prompt, and press Enter.

CAUTION: *Do not specify a physical disk that is shared (such as a disk containing database partitions for the ORACLE Parallel Server™ or Distributed Lock Manager). Shared disks don't support file systems.*

After you have answered all the prompts, the Installer program displays a new table of values showing your modifications. When you are satisfied with your modifications, press Enter after the prompt.

Modify this information [no] ↵

The NetWorker package is now installed, and the Installer program will continue with the next package.

Select software packages to set up

Continued

Setting up NFS and ONC

NFS is set up automatically without your input.

To set up Open Network Computing (ONC), you need only supply the host's NIS domain name. For example, if your NIS domain name was "worknet," you would type the following:

```
Enter the NIS Domain name: worknet ↵
```

After you enter your NIS Domain name, the Installer program will ask you to confirm the name.

```
[worknet] Correct? [yes]
```

- To confirm the NIS Domain name, press Enter.
- To correct the NIS Domain name, type "no" and press Enter. Then repeat the process.

A completion message appears when ONC is successfully set up.

Notes on NFS and ONC

Initially, your computer runs as an NIS client. NFS and ONC may require further setup (such as changing your host from an NIS client to either an NIS master or NIS server). See *Managing ONC™ /NFS® and its Facilities on the DG/UX™ System* for the final setup procedures.

You can find a detailed account of the ONC and NFS root setup in **onc.root** and **nfs.root** log files located in the directory **/var/setup.d/log**.

Setting up TCP/IP

When you set up TCP/IP, the system will ask you for your hostname and its Internet address. Remember, we had you collect this network information earlier and record it on the Planning Worksheet in Step 13.

Select software packages to set up

Continued

The exact text of your screen dialog depends on whether your computer has one or more Ethernet LAN controllers. Refer to the sample dialog below that is appropriate for your system's Ethernet LAN configuration.

IMPORTANT: You will set up a VME token ring or FDDI controller after the DG/UX system installation is complete. Follow this **sysadm** path:

Networking -> TCP/IP -> Interface

For details, see the section on maintaining network interfaces in *Managing TCP/IP on the DG/UX™ System*.

Single Ethernet LAN controller

The following is a sample setup dialog for a single Ethernet LAN controller where we use the values **moe**, **128.224.1.2**, **0xffffffff00** for the hostname, Internet address, and network mask, respectively. You would substitute the appropriate values for your system.

The following queries refer to the primary network interface:

```
Enter host name: moe ↵
[moe] Correct? [yes] ↵
Enter host Internet address: 128.224.1.2 ↵
[128.224.1.2] Correct? [yes] ↵
Is your local network subnetted? [no] yes ↵
Enter the network mask: 0xffffffff00 ↵
[0xffffffff00] Correct? [yes] ↵
```

NOTE: Using "dgen0" as the primary network interface controller.

Package setup for tcpip is completed.

Multiple Ethernet LAN controllers

The following is a sample setup dialog for multiple Ethernet LAN controllers where we use the values **moe**, **128.224.1.2**, **0xffffffff00** for the hostname, Internet address, and network mask, respectively. You would substitute the appropriate values for your system.

Select software packages to set up

Continued

The following queries refer to the primary network interface:

```
Enter host name: moe ↵
[moe] Correct? [yes] ↵
Enter host Internet address: 128.224.1.2 ↵
[128.224.1.2] Correct? [yes] ↵
Is your local network subnetted? [no] yes ↵
Enter the network mask: 0xfffff00 ↵
[0xfffff00] Correct? [yes] ↵
```

The following Ethernet controller devices are configured on this system

```
dgen0 hken0 hken1
```

```
Enter controller device name [dgen0]
Package setup for tcpip is completed.
```

No Ethernet LAN controller

You need an Ethernet LAN controller to install TCP/IP. If you select TCP/IP as a package and have no Ethernet LAN controller, you will need to respond to the prompts to continue. The following is a sample setup dialog when there is no Ethernet LAN controller, and where we use the values **moe** and **128.224.1.2** for the dummy hostname and Internet address, thus allowing us to continue.

The following queries refer to the primary network interface:

```
Enter host name: moe ↵
[moe] Correct? [yes] ↵
Enter host Internet address: 128.224.1.2 ↵
[128.224.1.2] Correct? [yes] ↵
```

```
WARNING: No Ethernet controllers are configured on
this system. A primary network interface
will not be added at this time. You can
add TCP/IP network interfaces later through
sysadm (1M).
```

```
Package setup for tcpip is completed.
```

Select software packages to set up

Continued

Notes on TCP/IP

The file `/var/setup.d/log/tcpip.usr` contains a verbose description of the TCP/IP setup process.

Additional TCP/IP setup may be required depending on your network and site configuration. Consult *Managing TCP/IP on the DG/UX™ System* for information on the following additional TCP/IP features: routing, Domain Name System (DNS), daemon management, SNMP, sendmail, and network databases.

What next?

With the DG/UX packages all set up, now you are ready to build a DG/UX kernel for your computer.

17 Build and boot a configured kernel

After the package setup completes, you are ready to build a DG/UX kernel for your computer configuration. The Installer program builds a default system kernel using configuration data about devices, device drivers, streams modules, socket protocols, and tuneable parameters for the DG/UX system and software packages.

IMPORTANT: Stand-alone **sysadm** uses default values for general configuration variables to build your configured kernel. To set these variables to different values, you will need to rebuild your kernel after you complete the installation. Refer to *Managing the DG/UX™ System* for information on these procedures.

Files in the directory **/usr/etc/master.d** list the configuration variables and default values for kernel builds. The kernel is located in the file **/dgux** on the **root** logical disk.

Building a kernel

After package setup completes, the system displays the Install System Software Menu.

```
Install System Software Menu

1 Set up software
2 Build kernel
3 Boot kernel
4 All steps

Enter a number, a name, ? or <number>? for help, <NL> to
redisplay menu or q to quit: [All steps]:
```

► To build a kernel, select 2, and press Enter.

```
Enter a number, a name, ? or <number>? for help,
<NL> to redisplay menu or q to quit: [All steps] 2 ↵
System configuration file name: [system.aviion]
```

Build and boot a configured kernel

Continued

- ▶ Assign a new name to your system configuration file.

For example, if we continue to use **moe** as our system name, the dialog would appear as follows:

```
System configuration file name [system.aviion]: moe ↵  
[system.moe] Correct? [yes]:
```

- ▶ Confirm the filename by pressing Enter.

```
[system.moe] Correct? [yes]: ↵  
Operating system client? [no]:
```

- ▶ To signify that you are not installing an OS client, press Enter. Then to proceed, press Enter again.

```
Operating system client? [no]: ↵  
OK to perform operation? [yes]: ↵
```

When the system finishes building the kernel, you are ready to boot the kernel.

Booting the kernel

After the kernel build completes, the system displays the Install System Software Menu.

Install System Software Menu

- 1 Set up software
- 2 Build kernel
- 3 Boot kernel
- 4 All steps

Enter a number, a name, ? or <number>? for help, <NL> to
redisplay menu or q to quit: [All steps]:

Build and boot a configured kernel

Continued

- ▶ To boot the kernel, select 3, and press Enter.

```
Enter a number, a name, ? or <number>? for help,  
<NL> to redisplay menu or q to quit: [All steps] 3 ↵  
Boot path: [sd(ncsc(0),3,0)root:/dgux -3]
```

- ▶ To confirm the boot path and run level, press Enter.

Note that, as the sample dialog below illustrates, you boot the new kernel to a run level of 3 (multiuser mode).

```
Boot path: [sd(ncsc(0),3,0)root:/dgux -3] ↵  
All currently running processes will be killed.  
Are you sure you want to reboot the system? [yes]
```

- ▶ To boot the system now, press Enter.

```
Are you sure you want to reboot the system? [yes] ↵
```

The screen clears and the new kernel boots, displaying startup and other informative messages similar to the following.

```
Booting sd(ncsc(0),3,0)root:/dgux -3  
DG/UX System Release 5.4R3.10 Bootstrap  
Loading image.....  
DG/UX System Release 5.4R3.10, Version generic  
Using 32 Megabytes of physical memory  
Found 2 processor(s)  
Configuring devices.....  
Registering disks.....  
Using vdm(swap,2D039A43, 0C027700,0) as swap disk.  
No check necessary for vdm(root,2D1F019E, 0C027700,0).  
. <additional messages>  
.
```

NOTE: The run level change is complete. See /etc/log/init.log for a verbose description of the system initialization process.

Build and boot a configured kernel

Continued

If the kernel encounters a device it cannot configure, it displays an error message and configures the remaining devices. Depending on the circumstances, you may choose either to investigate and correct the problem on the spot, or postpone investigation until after your DG/UX system is operational. If, for example, a particular device requires repair, it might be prudent to complete your installation and work temporarily without that device.

- ▶ When the system finishes booting, your new DG/UX system is successfully installed. Congratulations! Now you are ready to log in.

18 Log in

When the DG/UX system is finished booting, a system login prompt similar to the following appears.

```
DG/UX System Release 5.4 Release 3.10
Console login:
```

- ▶ Type **sysadm** at the login prompt and press Enter.

```
Console login: sysadm ↵
Password:
```

- ▶ At the password prompt, press Enter.

```
Password: ↵
#
```

The superuser shell prompt (#) appears. The **sysadm** account does not require a password until you set one. You are now logged in as **sysadm**; next we will set the password.

- ▶ At the superuser shell prompt, type **passwd** and press Enter.

```
# passwd ↵
Changing password for sysadm
New password:
```

- ▶ Type the password you want to use for **sysadm** and press Enter.

```
New password: new_password ↵
Re-enter new password:
```

To help maintain security, your **sysadm** password does not appear on the screen as you type it. For information on legal passwords, see the **passwd(1)** manual page, or refer to *Managing the DG/UX™ System*.

Log in

Continued

- ▶ Retype the **sysadm** password you chose and press Enter.

```
Re-enter new password: new_password ↵  
#
```

The superuser shell prompt reappears. Your **sysadm** password is confirmed. Now we will set the **root** password.

- ▶ At the superuser shell prompt, type **passwd root** and press Enter.

```
# passwd root ↵  
Root password:
```

- ▶ Type the password you want to use for **root** and press Enter.

```
Root password: root_password ↵  
Re-enter new password:
```

To help maintain security, your **root** password does not appear on the screen as you type it. For information on legal passwords, see the **passwd(1)** manual page, or refer to *Managing the DG/UX™ System*.

- ▶ Retype the **root** password you chose and press Enter.

```
Re-enter new password: root_password ↵  
#
```

The superuser shell prompt reappears. Your **root** password is confirmed.

Now your system passwords are set. If at any time you want to change these passwords, type **passwd** or **passwd root** at the superuser shell prompt and repeat the procedure.

Logging in as **sysadm** gives you the superuser privileges required to use the system administration utilities collectively known as **sysadm**. These utilities provide a menu-driven set of system administration procedures that you use to customize your system.

IMPORTANT: The next section of this document lists customization tasks you might need to make your system fully operational.

19 Perform the final customization for your system

Your DG/UX system is installed, but before it is fully operational, you must perform some or all of the following tasks.

- Set up, activate, and verify AV/Alert. Refer to *Using AViiON[®] Diagnostics and the AV/AlertSM Diagnostic Support System* (014–002183).
- Set up CLARiiON storage systems. Refer to your CLARiiON documentation.
- Configure OS clients, X terminal clients, user home directories, file systems, and software packages and nonstandard devices. Refer to *Managing the DG/UX[™] System for the ORACLE Parallel Server[™]* (093–701134) and *Managing Mass-Storage Devices and the DG/UX[™] File Systems* (093–701136).
- Add printers. Refer to *Installing and Configuring Printers on the DG/UX[™] System* (093–701132).
- Set up a failover or multihost SCSI configuration. Refer to *Achieving High Availability on AViiON[®] Systems* (093–701133).

You may perform some of these tasks right away. You will perform others, like adding new I/O devices or packages, over the lifetime of your DG/UX system. In some instances, these tasks require you to build and boot a new custom kernel. For this information, refer to *Managing Mass-Storage Devices and DG/UX[™] File Systems* (093–701136).

Always read the DG/UX Release Notice for the latest information and developments in the software.

Additional TCP/IP features may be required depending on your network/site configuration. Consult *Managing TCP/IP on the DG/UX[™] System* (093–701051) for information on the following additional TCP/IP features: routing, Domain Name System (DNS), daemon management, SNMP, sendmail, and network databases.

End of Instructions

