

THIS DRAWING AND SPECIFICATIONS HEREIN ARE THE PROPERTY OF DATA GENERAL CORPORATION AND SHALL NOT BE REPRODUCED OR COPIED OR USED IN WHOLE OR IN PART AS THE BASIS FOR MANUFACTURE OR SALE OF ITEMS WITHOUT WRITTEN PERMISSION.

REVISIONS				
REV.	DESCRIPTION	DRFTG.	APP. BY	DATE
01	ECO 393	RNK		7-1-71
02	ECO 385	WJG		11/2/71
03	REV PER ECO 713	REB		11/2/71

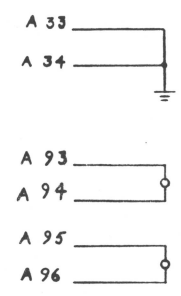

+5V 6.8 35VDC
 .05MFD 60EACH
 NUMBERS C4-25
 C27-13
 C47-59
 C62-71

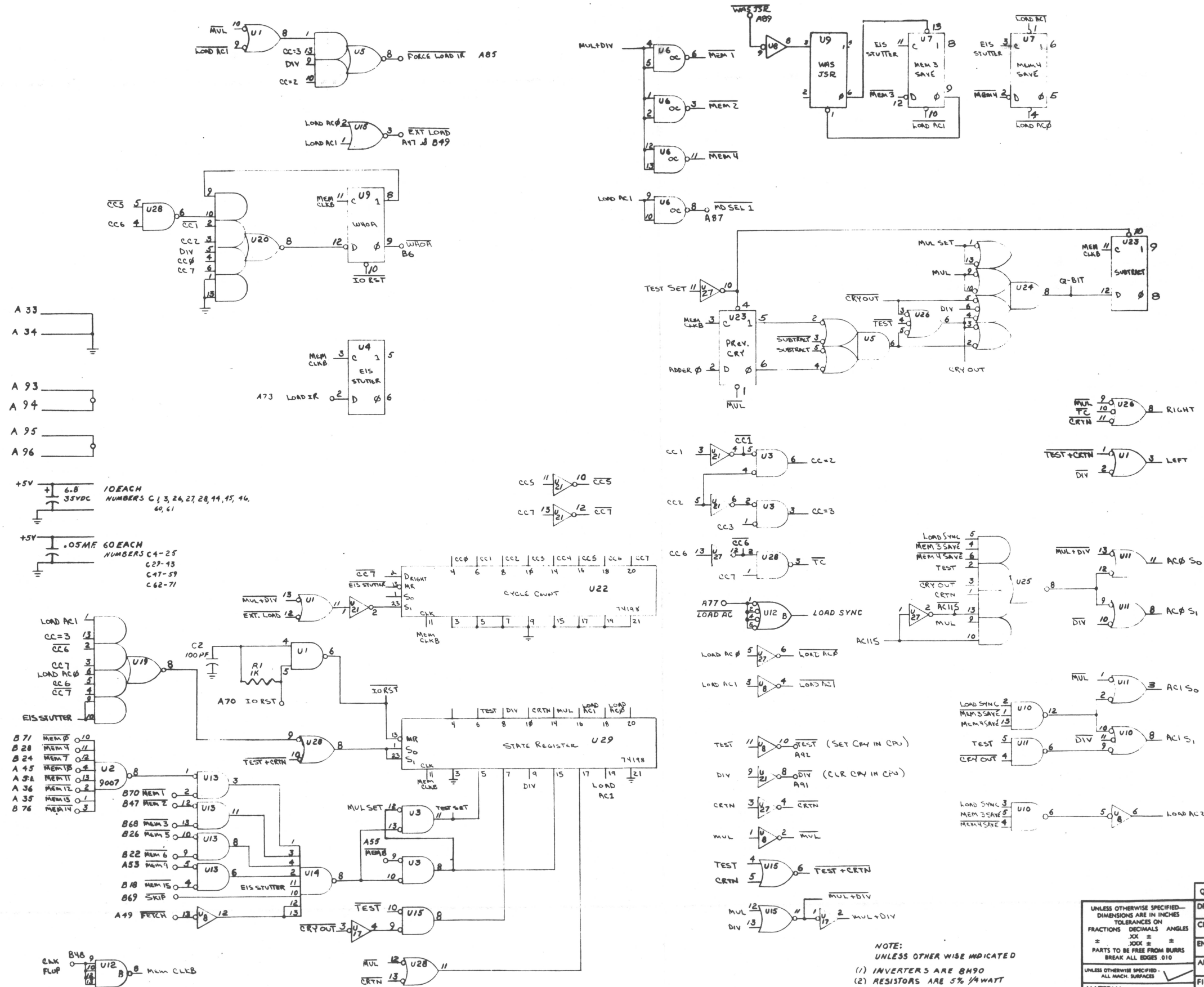
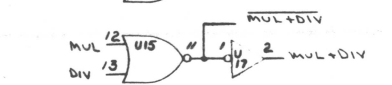
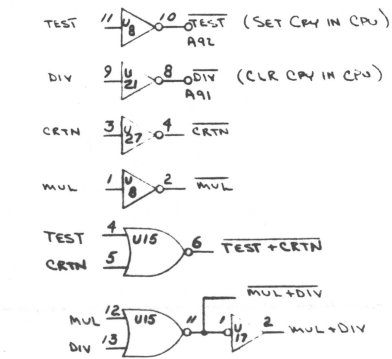
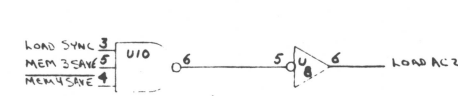
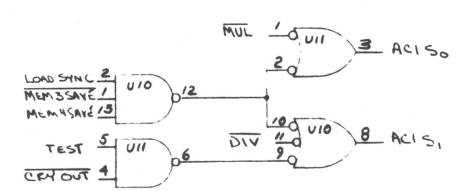
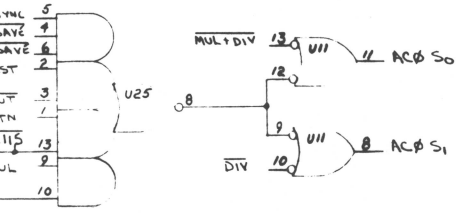
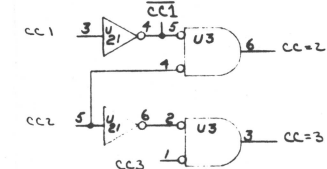
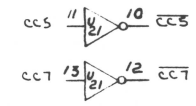

NOTE:
 UNLESS OTHERWISE INDICATED
 (1) INVERTERS ARE 8M90
 (2) RESISTORS ARE 5% 1/4 WATT

DIVIDE NOTES:

TEST: AC0 - AC2
 IF NO CARRY OUT OF ADDER, SHIFT RIGHT
 LEFT
 IF CARRY OUT OF ADDER, TERMINATE DIVIDE.

DIV: ALWAYS ADD DURING FIRST CYCLE
 AFTER TEST.
 IF LAST QUOTIENT BIT = 0, THEN:
 AC0 + AC2 → AC0
 AC0 + AC1 SHIFTED LEFT, Q-BIT → AC15
 IF LAST QUOTIENT BIT = 1, THEN:
 AC0 - AC2 → AC0
 AC0 + AC1 SHIFTED LEFT, Q-BIT → AC15
 QUOTIENT BIT = CRY OUT ⊕ SUBTRACT
 ⊕ PREV CRY
 DURING LAST CYCLE (TC), DON'T
 SHIFT AC0.

CRTN: IF FINAL QUOTIENT BIT = 1, THEN:
 DO NOTHING, YOU'RE FINISHED
 IF FINAL QUOTIENT BIT = 0, THEN:
 AC0 + AC2 → AC0
 DON'T SHIFT AC0 OR AC1

QTY.	DESCRIPTION	PART NO.
	DATA GENERAL CORPORATION	
	SOUTHBORO, MASSACHUSETTS 01772	
	TITLE	
	MUL/DIV	
	NOVA 1200	
	SIZE	
D	CODE	
	DRAWING NUMBER	
	000131	
	REV.	
	03	

THIS DRAWING AND SPECIFICATIONS, HEREIN, ARE THE PROPERTY OF DATA GENERAL CORPORATION AND SHALL NOT BE REPRODUCED OR COPIED OR USED IN WHOLE OR IN PART AS THE BASIS FOR MANUFACTURE OR SALE OF ITEMS WITHOUT WRITTEN PERMISSION.

REVISIONS				
REV.	DESCRIPTION	DRFTG.	APP. BY	DATE
03	PER SHEET 1	JPD		4/17/71

D

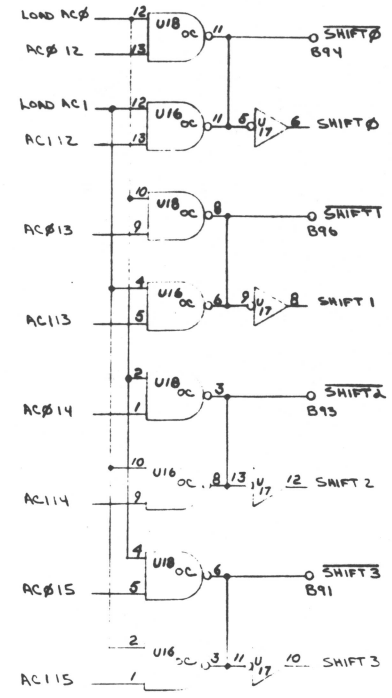
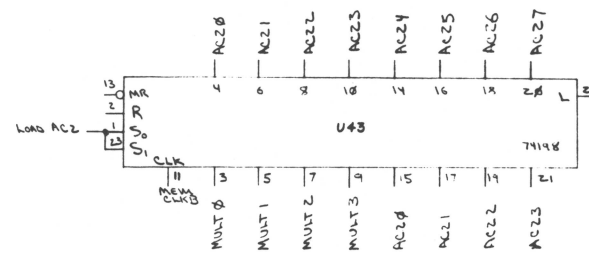
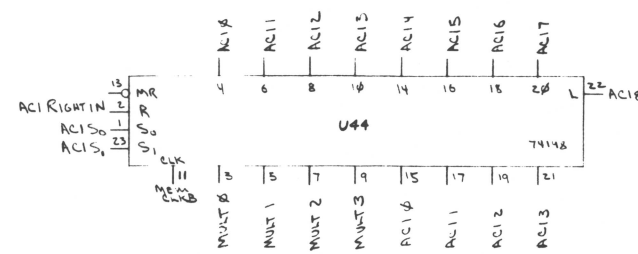
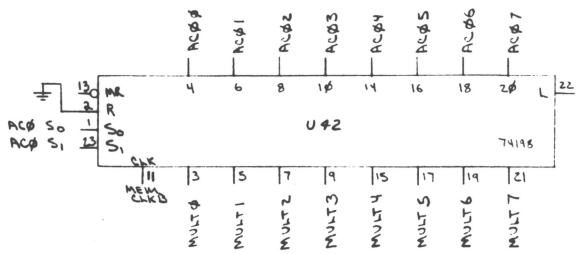
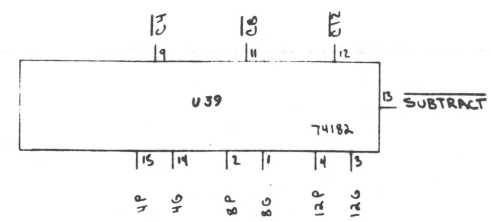
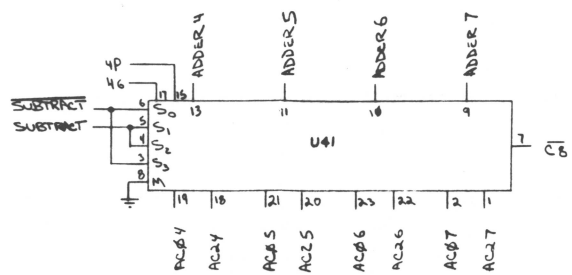
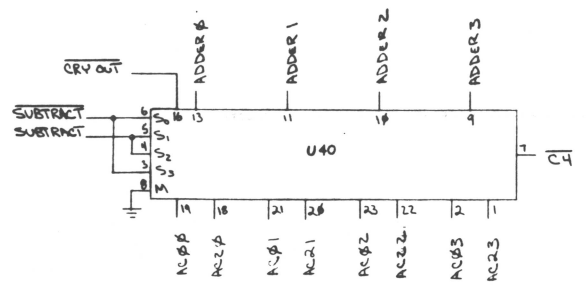

C

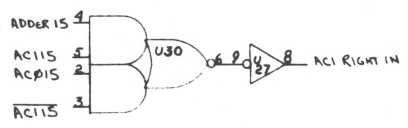
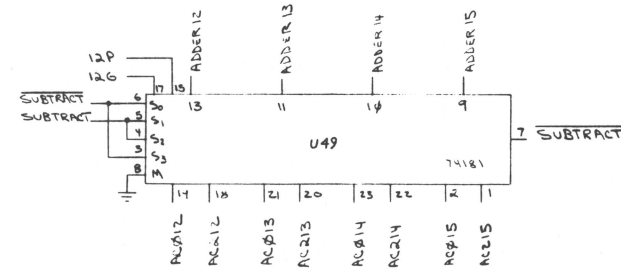
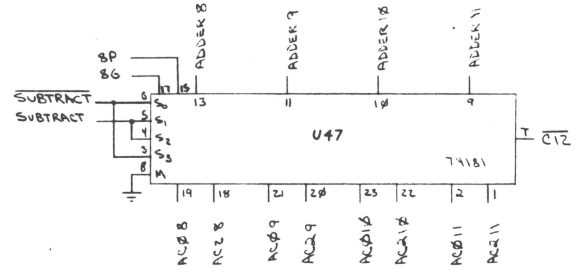
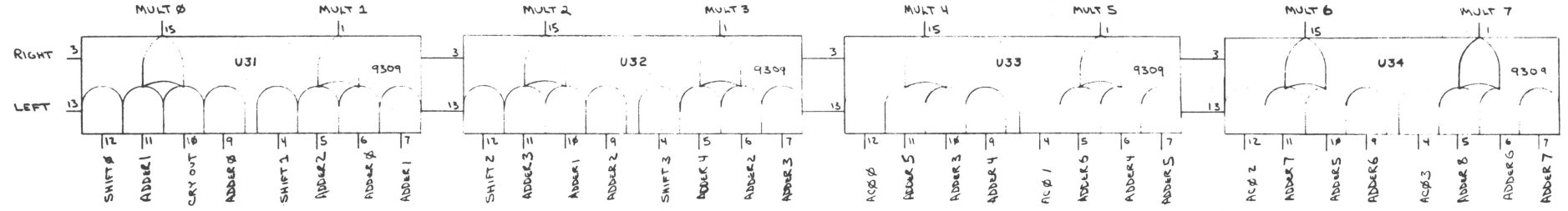

B

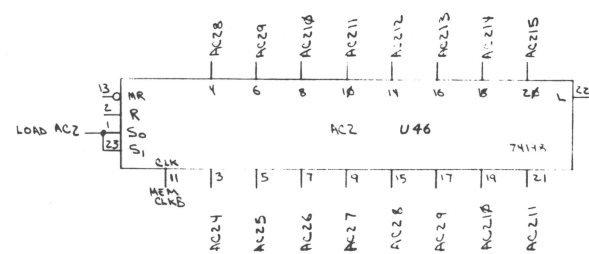
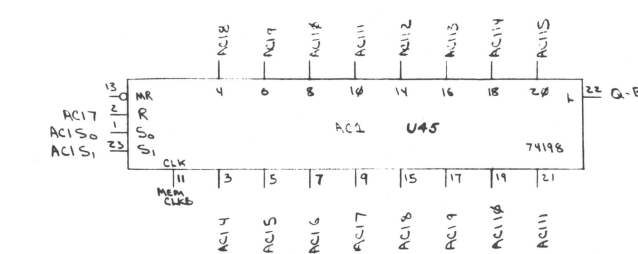
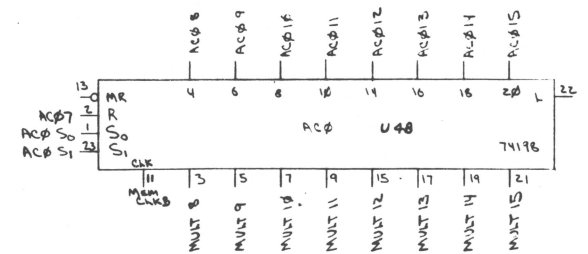

A

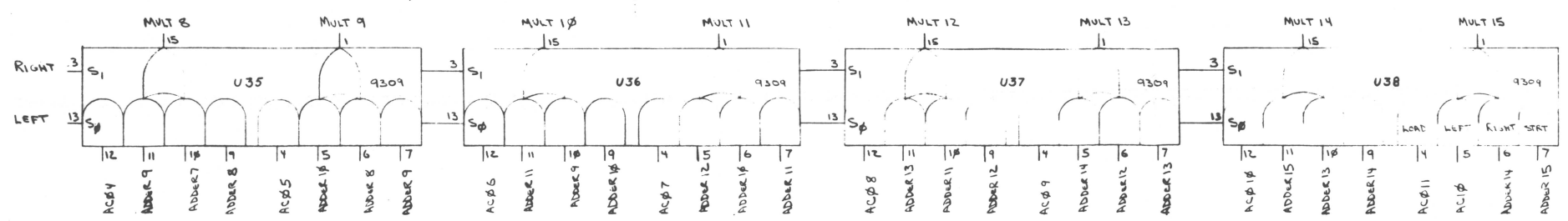

QTY.	DESCRIPTION	PART NO.
	DATA GENERAL CORPORATION	
	SOUTHBORO, MASSACHUSETTS 01772	
	TITLE	
	MUL/DIV	
	NOVA 1200	
	SIZE	CODE
D	001	000131
	DRAWING NUMBER	REV.
		03