

Field Engineer's  
Maintenance Series  
**DASHER™ D100**  
and **D200**  
**Display Terminals**

015-000102-00

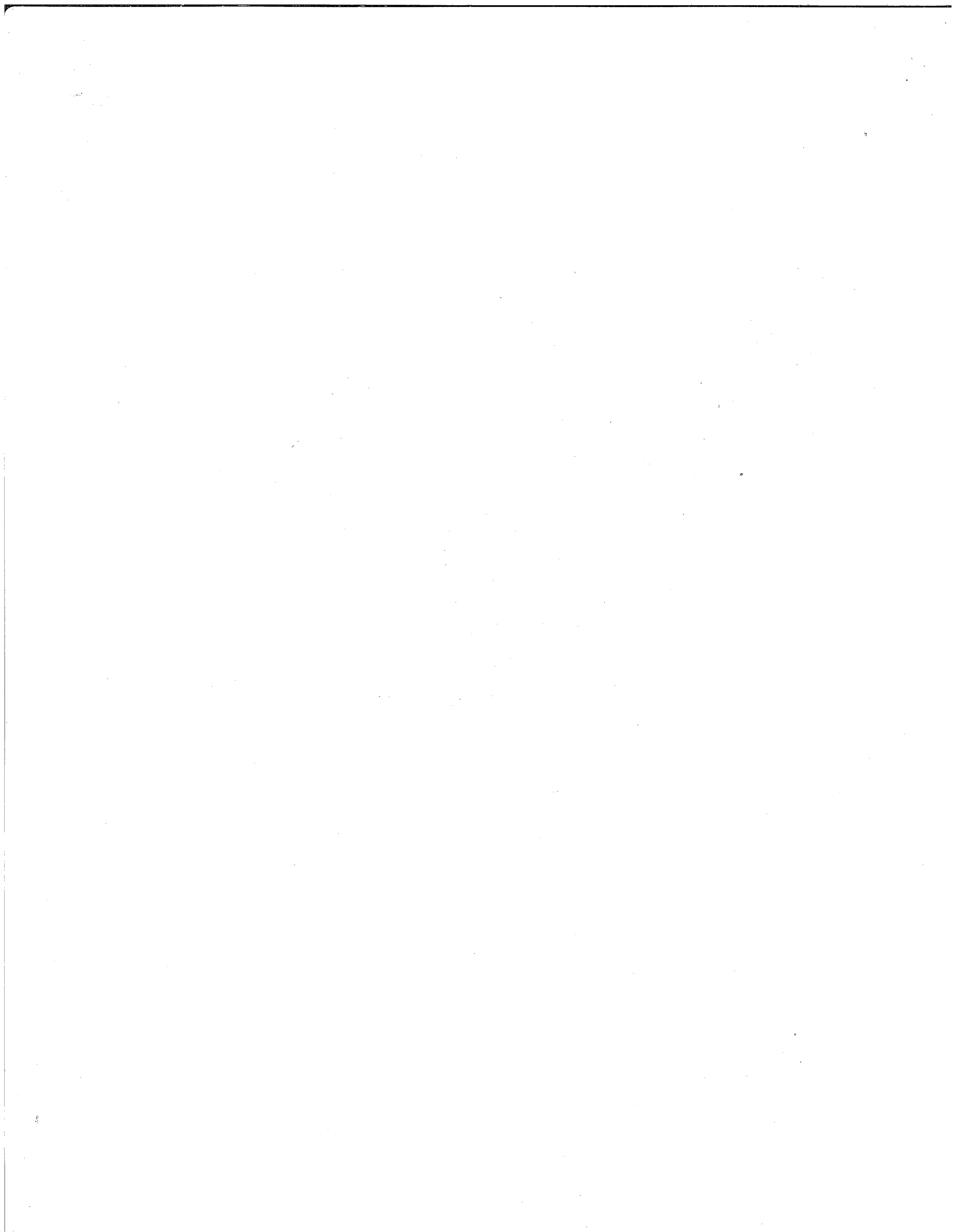

**PRELIMINARY**

**Field Engineer's  
Maintenance Series  
DASHER™ D100  
and D200  
Display Terminals**

015-000102-00

## NOTICE

Data General Corporation (DGC) has prepared this manual for use by DGC personnel and customers as a guide to the proper installation, operation, and maintenance of DGC equipment and software. The drawings and specifications contained herein are the property of DGC and shall neither be reproduced in whole or in part without DGC prior written approval nor be implied to grant any license to make, use, or sell equipment manufactured in accordance herewith.

DGC reserves the right to make changes without notice in the specifications and materials contained herein and shall not be responsible for any damages (including consequential) caused by reliance on the materials presented, including but not limited to typographical or arithmetic errors, company policy and pricing information. The information contained herein on DGC software is summary in nature. More detailed information on DGC software is available in current released publications.

**NOVA**, **INFOS** and **ECLIPSE** are registered trademarks of Data General Corporation, Westboro, Massachusetts. **DASHER** and **microNOVA** are trademarks of Data General Corporation, Westboro, Massachusetts.

Ordering No. 015-000102  
©Data General Corporation, 1979  
All Rights Reserved  
Printed in the United States of America  
Rev. 00, December 1979

The affixation of a copyright notice on this Technical Manual is not intended by itself to render the distribution of this Technical Manual a publication.

## PREFACE

This field service maintenance manual tells how to troubleshoot and repair DASHER D100/D200 display terminals at the board-swap level. Thus, the troubleshooting procedures described herein isolate problems to the field replaceable units (FRUs) defined for these products by Data General Corporation.

The manual is organized around four parts:

- Part 1 introduces the terminals and tells how to operate them. It also defines the FRUs.
- Part 2 provides installation, initial check-out and troubleshooting procedures, which includes interpretation of the terminal's self-test, visual and manual check-outs and use of the diagnostics.
- Part 3 provides an overview of theory of operation.
- Part 4 contains replacement and adjustment procedures.

Throughout the manual, it is assumed that the field service engineer performing the troubleshooting procedures has access to a voltmeter and a DASHER terminal tester and knows how to use them.

## CONTENTS

### PREFACE

### PART 1 PRODUCT DESCRIPTION

#### CHAPTER 1 INTRODUCTION TO DASHER D100 AND D200 TERMINALS

- 1-1 Display
- 1-2 Technical Specifications
- 1-3 Keyboard
- 1-4 Split baud/printer Option
- 1-4 Self-test
- 1-4 Components
  - 1-5 Printer Circuit Board
  - 1-7 CRT/yoke Assembly
  - 1-7 Keyboard
- 1-8 Field Replaceable Units
- 1-11 Related Documentation

#### Chapter 2 HOW TO OPERATE THE TERMINAL

- 2-1 Power On/Off and Screen brightness
- 2-2 Un Line/Off Line Mode
- 2-4 Cursor Lock/Unlock Mode
- 2-4 Display Commands
- 2-7 Terminal Identification/Diagnostic Commands
- 2-8 Print Commands
- 2-9 User Function Codes

### PART 2 INSTALLING AND TROUBLESHOOTING

#### CHAPTER 3 , INSTALLATION PROCEDURES

- 3-1 Choosing A Site
- 3-3 Unpacking
- 3-4 Communications Interface Tailoring
- 3-5 Printer Interface Tailoring

#### CHAPTER 4 INTRODUCTION TO TROUBLESHOOTING

- 4-1 Troubleshooting Flowchart

#### CHAPTER 5 MANUAL TROUBLESHOOTING

- 5-1 Self-test
- 5-3 Off-line Checkout
- 5-6 Manual On-line Checkout
- 5-8 Screen Parameter Checkout

## CHAPTER 6 TROUBLESHOOTING WITH TEST PROGRAMS

### 6-1 Using PRINT X

## PART 3 FUNCTIONAL OVERVIEW

### CHAPTER 7 OPERATIONAL OVERVIEW

- 7-1 Printed Circuit Board
- 7-1 Control Logic
- 7-4 Display Logic
- 7-4 Interface Logic
- 7-5 Power Supply
- 7-6 CRT/Yoke Assembly
- 7-7 Keyboard
- 7-8 Operation
- 7-8 Powering Up
- 7-8 Scanning Keyboard
- 7-10 Communications Interface
- 7-10 Processing Codes
- 7-10 Displaying Characters
- 7-11 FRU Interconnection

## PART 4 REPLACEMENT AND ADJUSTMENT PROCEDURES

### CHAPTER 8 REMOVING AND INSTALLING FRUS

- 8-2 Opening and Closing the Display Case
- 8-3 American Keyboard Replacement
- 8-3 Export Keyboard Replacement
- 8-8 Printed Circuit Board and CRT/Yoke Assembly Replacements
- 8-8 Disconnecting the Board and the CRT/Yoke Assembly
- 8-11 Replacing the Printed Circuit Board
- 8-14 Replacing the CRT/Yoke Assembly
- 8-15 Bleeding the CRT Vacuum
- 8-16 Connecting the Board and the CRT/Yoke Assembly

### CHAPTER 9 ADJUSTING THE DISPLAY

- 9-2 +5V Supply Adjustment
- 9-3 Screen Width Adjustment
- 9-3 Screen Height Adjustment
- 9-3 Bias Adjustment
- 9-3 Focus Adjustment

## APPENDICES

APPENDIX A ASCII Codes Displayed by D100/D200 Terminals

APPENDIX B International Character Fonts

- B-2 American Usage
- B-4 british Usage
- B-5 French Usage
- B-5 German Usage
- B-5 Spanish Usage
- B-6 Swedish/Finnish Usage
- B-6 Danish/Norwegian Usage

APPENDIX C Cabling

- C-1 EIA Connection
- C-3 Current Loop Connection
- C-5 Printer Connection



Data General Corporation (DGC) has prepared this manual for use by DGC personnel and customers as a guide to the proper installation, operation, and maintenance of DGC equipment and software. The drawings and specifications contained herein are the property of DGC and shall neither be reproduced in whole or in part without DGC's prior written approval nor be implied to grant any license to make, use, or sell equipment manufactured in accordance herewith.

## PART 1

### PRODUCT DESCRIPTION

Data General Corporation (DGC) has prepared this manual for use by DGC personnel and customers as a guide to the proper installation, operation, and maintenance of DGC equipment and software. The drawings and specifications contained herein are the property of DGC and shall neither be reproduced in whole or in part without DGC's prior written approval nor be implied to grant any license to make, use, or sell equipment manufactured in accordance herewith.

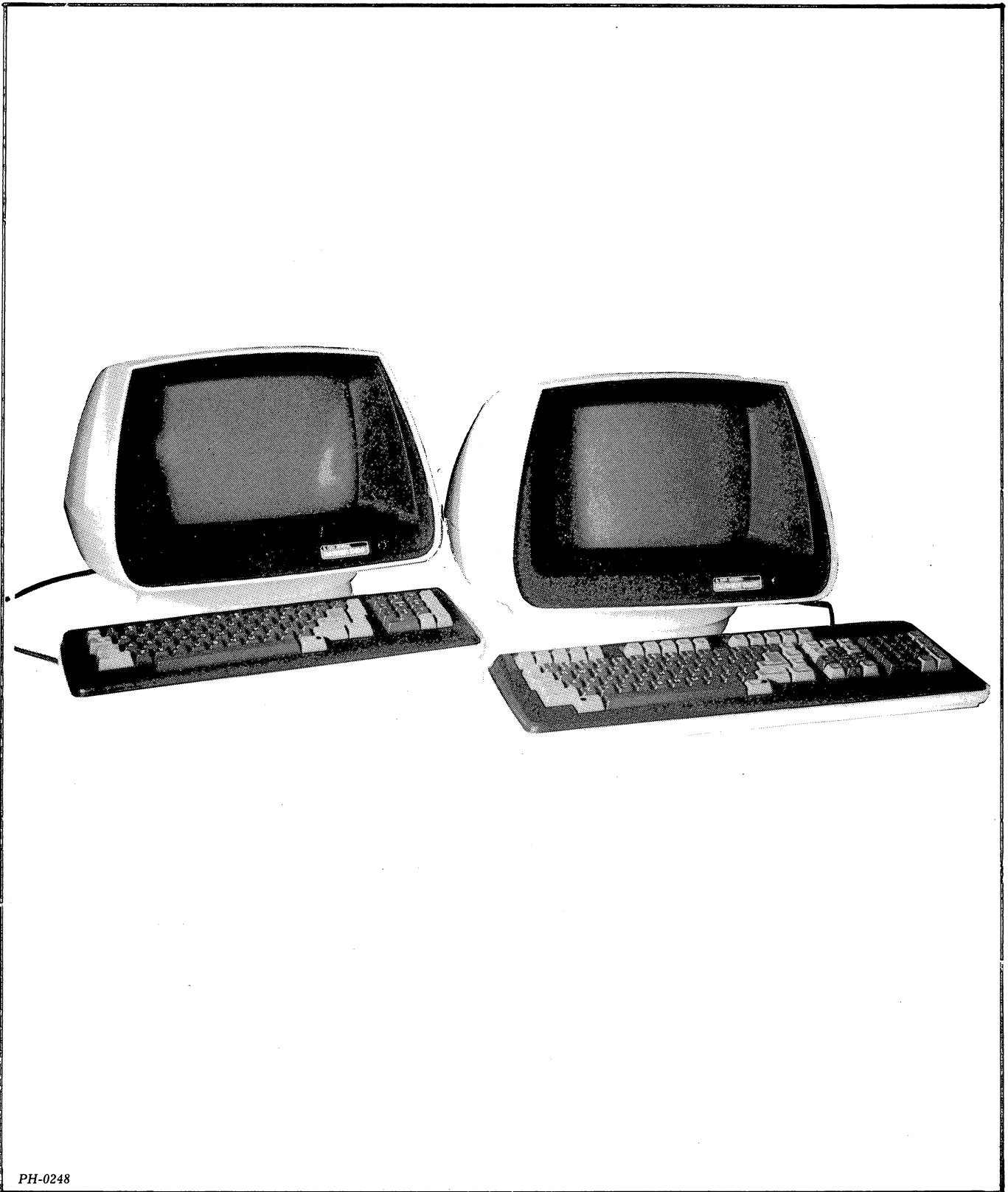

PH-0248

Figure 1.1 DASHER D100 and D200 display terminals

## CHAPTER 1

### INTRODUCTION TO DASHER D100/D200 DISPLAY TERMINALS

DASHER D100/D200 display terminals are ASCII-based, soft copy devices that support the full upper/lower case, alphanumeric printing character set. Both terminals are offered with the following choice of international character fonts: American, British, Danish/Norwegian, French, German, Spanish and Swedish/Finnish.

The terminals communicate with a computer or communications system in full-duplex mode over either a 20mA current loop or EIA RS-232-C communications line. Both models support a subset of standard EIA modem control functions that allows them to interface to Bell 103, 113 or 212 compatible modems.

Both the D100 and D200 terminals consist of two units: an alphanumeric CRT display, mounted on a swivel base, and a detached keyboard. A 3.95 foot (1.2 meter) external cable connects them. On line, the display and keyboard function as two independent I/O devices, while sharing a common asynchronous interface located in the display unit to communicate with a computer or communications system.

The terminal's asynchronous interface transmits and receives serial data bursts at transmission rates ranging from 50 to 19200 bits per second. Each data burst contains 7 data bits; the remaining code parameters (i.e., parity and number of stop bits) together with the transmission rate are switch-selectable.

#### Display

The display unit of both terminals has a 1920-character semiconductor memory and a non-interlaced video monitor with a 12 inch diagonal screen. The screen's active area is 8.5 inches by 5.5 inches, formatted as 24 lines, 80 characters per line.

All displayable characters sent to the display are stored in memory and appear on the screen as 7 by 11 dot matrices. The non-destructive cursor is displayed as a solid white field; i.e., all dots in the dot matrix are intensified.

All control characters sent to the display are decoded and interpreted as either display commands or protocol characters. The latter are ignored. In general, display commands perform the following functions:

- Control the screen and position the cursor
- Assign attributes (i.e., blink, dim, underscore, reverse video) to displayable characters.
- Provide terminal identification information and place the terminal in diagnostic mode.

Detailed information about the display command set appears in Chapter 2.

## Technical Specifications

### General

<b>Display</b>	Tabletop mounting. 12 in. diagonal screen; 24 lines by 80 characters/line in active area 8.5 in. by 5.5 in.
<b>Characters</b>	7 x 11 dot matrix characters
<b>Character Fonts</b>	American, British, Danish/Norwegian, French, German, Spanish, and Swedish/Finnish
<b>Keyboard</b>	Independent tabletop mounting; n-key roll over; typematic and manual repeat; user definable function keys
<b>Self Test Interface</b>	Diagnostic routine checks terminal at power-up. Asynchronous serial; full-duplex; EIA RS232-C and 20mA current loop. Compatible with Bell 103, 113, and 212 type modems.
<b>Baud Rates</b>	50, 75, 110, 134.5, 150, 300, 600, 1200, 1800, 2400, 3600, 4800, 7200, 9600, and 19200 bits per second.
<b>Data Format</b>	ASCII; 7 data bits; even, odd, mark, or no parity; one stop bit (two stop bits at or below 110 baud).
<b>Printer / Split Baud Option</b>	Second interface for serial ASCII-based printer; EIA RS232-C; 110, 300, 600, 1200, 1800, 2400, 3600, or 4800 baud; 7-data bits; even parity; one stop bit (two stop bits at or below 110 baud). Allows separate receive baud selection (50 - 19,200 baud) and transmit baud selection (110 - 4800 baud). In split baud mode, one stop bit is selected for all terminal communications (including printer).

### Electrical

<b>Power Requirements</b>	100 volts AC, 50 hz.; 120 volts AC, 60 hz.; 220/240 volts AC, 50hz.
<b>Power Consumption</b>	50 watts maximum (171 BTU per hour)
<b>Display Refresh Rate</b>	60 frames/second (domestic) 50 frames/second (foreign)
<b>Display Scan</b>	Noninterlaced raster
<b>Line Cord</b>	1.8 meters (6 feet)
<b>Keyboard Cable</b>	1.2 meters (3.95 feet)
<b>I/O Cable</b>	EIA interface -- 15.2 meters (50 feet) maximum. 20mA current loop interface at 9600 baud or below -- 457.2 meters (1500 feet) maximum.

### Mechanical

<b>Display Dimensions</b>	Height: 33.2 cm (13.2 inches) Width: 41.0 cm (16.1 inches) Depth: 44.9 cm (17.7 inches)
<b>D100 Keyboard Dimensions</b>	Height: 5.8 cm (2.3 inches) Width: 45.2 cm (17.8 inches) Depth: 16.2 cm (6.4 inches)
<b>D200 Keyboard Dimensions</b>	Height: 6.0 cm (2.4 inches) Width: 51.8 cm (20.4 inches) Depth: 19.0 cm (7.5 inches)
<b>Weight</b>	Display -- 10 Kg (22 lbs) D100 Keyboard -- 1.1 Kg (2.4 lbs) D200 Keyboard -- 1.6 Kg (3.5 lbs)

### Environmental

<b>Temperature Ranges</b>	Operating : 0 to 45 degC (32 to 113 degF) Storage: -40 to +40 degC (-40 to 104 degF)
<b>Humidity</b>	Operating: 10% to 90% noncondensing Storage: 10% to 90% noncondensing
<b>Altitude</b>	3048 meters (10,000 feet)
<b>Radiation</b>	Below 0.5 milliroentgens per hour (complies with Underwriters Laboratories Standard 478)

### Models

<b>6106</b>	D100 Display Terminal
<b>6107</b>	D100 Display Terminal with split baud and printer option
<b>6108</b>	D200 Display Terminal
<b>6109</b>	D200 Display Terminal with split baud and printer option

## Keyboard

Figures 1.2 and 1.3 show the D100 and D200 keyboards, respectively. Both keyboards have typewriter-style main keypads and one or more supplementary keypads. D100 keyboards contain one supplementary keypad that combines screen management functions with standard numeric keys. D200 keyboards contain two supplementary keypads -- screen management and numeric -- plus 15 user function keys.

A user function key, when pressed, initiates the transmission of a two-code sequence. The first code of each user-function sequence is the header code that identifies the second code as a user-defined control character. While D200 keyboards contain 15 dedicated user function keys, D100 and D200 keyboards can generate 35 and 75 unique user function two-code sequences.



Figure 1.2 D100 keyboard

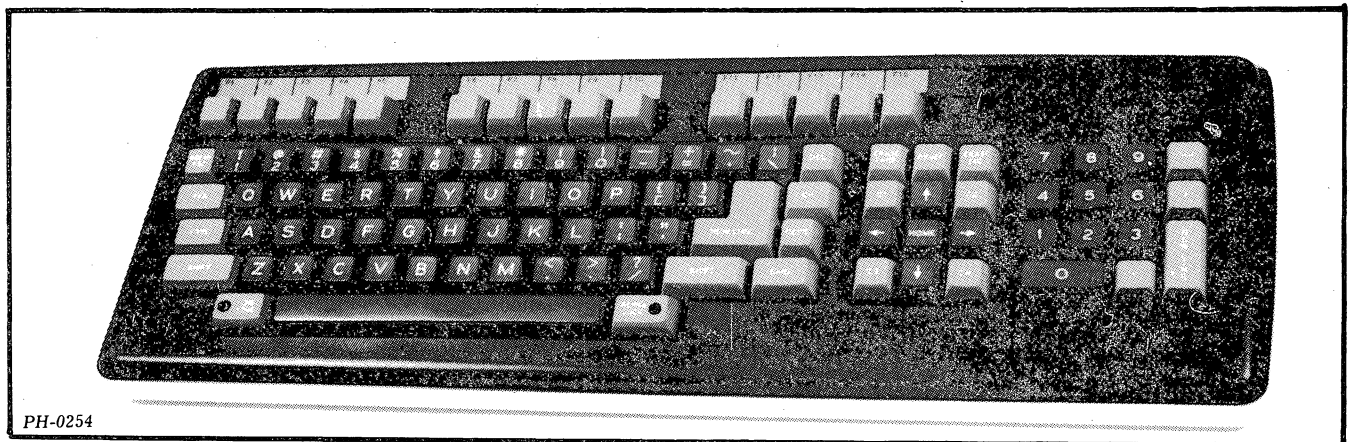

Figure 1.3 D200 keyboard

## Split Baud/Printer Option

Both terminals are available with a "split baud and printer" option that expands their functional capabilities in the following manner. The split baud portion of the option allows the independent selection of transmit and receive rates, thus supporting a communication line with two bandwidths -- one high-speed and one low-speed. The printer portion of the option allows the terminal to interface to an ASCII-based, serial printer, thus providing facilities for hardcopy output of information displayed on the terminal's screen.

## Self-Test

On power-up, D100/D200 terminals execute a self-test that verifies the proper operation of the terminal's control logic and the presence of the keyboard. If the terminal fails its self-test, it either halts or generates a bell tone and displays a failure code on the screen.

## COMPONENTS

Functionally, D100/D200 terminals consist of three major assemblies:

- 15.5 inch by 13 inch printed circuit board
- CRT/yoke assembly
- Keyboard with attached external cable

Opening the display case from the front of the unit exposes the first two major assemblies, as shown in Figure 1.4. The third major assembly, the keyboard, connects to the printed circuit board through its external cable that plugs into a receptacle at the rear of the display unit. Figure 1.5 shows the keyboard connection as well as the connections provided for the 20mA current loop or EIA RS-232-C communications line and, optionally, the EIA RS-232-C line of the printer.

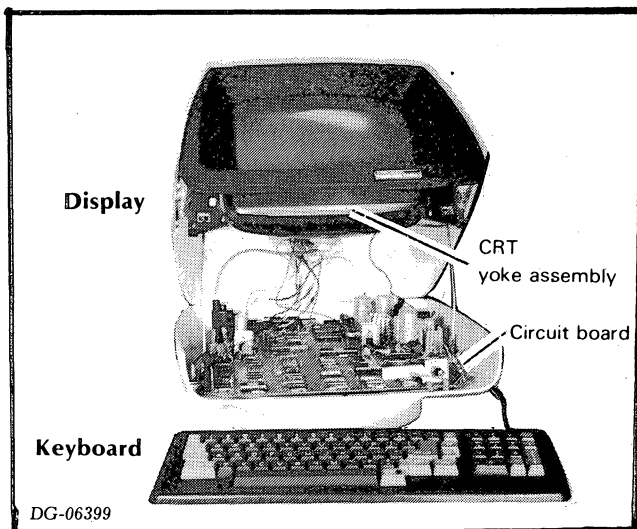

Figure 1.4 Terminal components

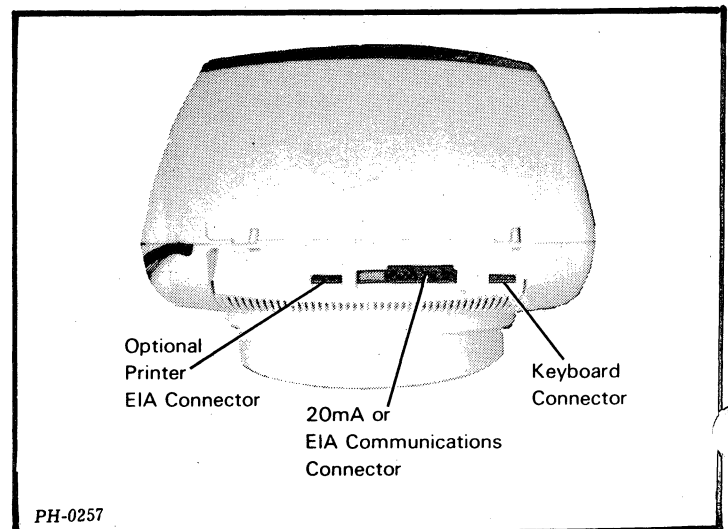

Figure 1.5 External cabling

## Printed Circuit Board

This board directs all terminal operations. As shown in Figure 1.6, it consists of four, or optionally five, major sections:

- Communications interface
- Terminal control logic, including memory
- Keyboard interface
- Power supply
- Optional printer interface

With the exception of the power supply, the major sections are organized around one, bidirectional, data path plus address/control lines.

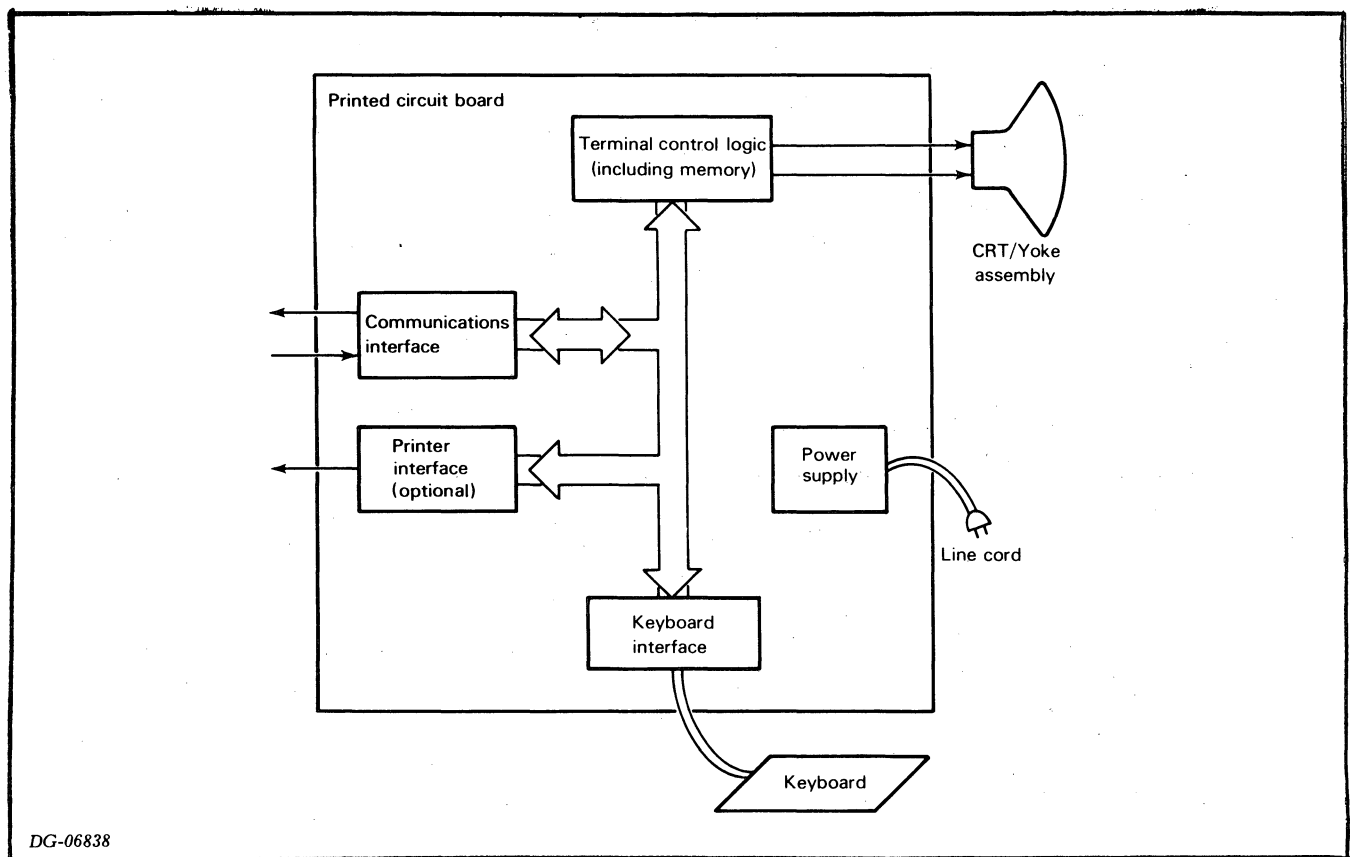

Figure 1.6 Simplified terminal block diagram

## Communications Interface

Through this interface, the terminal communicates in full-duplex mode with the host system. On-board switches allow the user to define the transmission rate and serial character format of the data that is asynchronously transmitted and received.

## Terminal Control Logic

The microprocessor-driven control logic directs the activities of the terminal by performing the following major tasks.

1. Initiates the self-test on power up.
2. Senses the switch settings of the communications interface and the optional printer interface, when present, and selects the appropriate line characteristics for both interfaces.
3. Decodes the ASCII characters supplied by the communications interface and responds in the following manner:
  - a. Assigns the appropriate character attributes (i.e., blink, dim, underscore, reverse video) to displayable characters, as defined by the display attribute commands. It then stores the character together with its attributes in memory.
  - b. Initiates the function specified by display commands.
  - c. Ignores control characters not recognized as display commands.
4. Drives the video monitor circuits to display the contents of memory on the screen and position the cursor.
5. Scans the keyboard and, when appropriate, sends the ASCII character codes for the depressed keys to the communications interface.
6. Sends all or a portion of the contents of memory to the printer interface when a print command is received and the split baud/printer option is present.



## Keyboard Interface

The keyboard interface together with the external cable attached to the keyboard form the communications link between the terminal control logic and the keyboard's integral printed circuit board. The interface passes addresses and control information to the keyboard's printed circuit board and receives an acknowledging pulse when an addressed key is depressed.

## Power Supply

The on-board power supply converts the supply line's a.c. power into the d.c. voltages required by the printed circuit board, the video monitor, and the keyboard.

## Printer Interface

The optional printer interface transmits the information provided by the terminal control logic over an EIA RS-232-C communications line to a local, ASCII-based, serial printer. On-board switches allow the user to define the transmission rate and serial character format of the data that is asynchronously transmitted.

## CRT/Yoke Assembly

This assembly is the terminal's output device. It contains a video monitor that uses a non-interlaced raster pattern of scanning to display printing characters on its screen in 7 by 11 dot matrix form. Its electron beam scans the screen to display 24 lines of characters, 80 characters wide.

## Keyboard

This assembly is the terminal's input device. It contains two or more keypads plus LED indicator lights that are connected to a printed circuit board. The printed circuit board is arranged in a matrix of scan and sense lines that allows the terminal control logic to address the keys and receive notification when an addressed key is pressed.

## FIELD REPLACEABLE UNITS

The field replaceable units (FRUs) for D100/D200 terminals are listed according to international character font in tables 1.1 through 1.7. Replacement procedures appear in Chapter 8, Removing and Replacing FRUs.

Table 1.1 American Field Replaceable Units

FRU	Part Number
D100 keyboard	005-013687
D200 keyboard	005-014128
Main circuit board without split baud/printer option:	
120V, 60Hz	005-014529
100V, 50Hz	005-014529
220/240V, 50Hz	005-014531
Main circuit board with split baud/printer option:	
120V, 60Hz	005-014529
100V, 50Hz	005-014529
220/240V, 50Hz	005-014533
CRT/yoke assembly	005-013701

Table 1.2 British Field Replaceable Units

FRU	Part Number
D100 keyboard	005-013687
D200 keyboard	005-014128
Main circuit board (240V, 50Hz):	
without split baud/printer option	005-014533
with split baud/printer option	005-014531
CRT/yoke assembly	005-013701
Keycaps	005-014672
Character ROM	100-002484

Table 1.3 Danish/Norwegian Field Replaceable Units

FRU	Part Number
D100 keyboard	005-013687
D200 keyboard	005-014128
Main printed circuit board (220V, 50Hz):	
without split baud/printer option	005-014533
with split baud/printer option	005-014531
CRT/yoke assembly	005-013701
Keycaps	005-015439
Font option ROM	100-002518
Character ROM	100-002517

Table 1.4 French Field Replaceable Units

FRU	Part Number
D100 keyboard	005-013687
D200 keyboard	005-014128
Main printed circuit board	
without split baud/printer option:	
120V, 60Hz	005-014529
220V, 50Hz	005-014533
Main printed circuit board	
with split baud/printer option:	
120V, 60Hz	005-013685
220V, 50Hz	005-014531
CRT/yoke assembly	005-013701
Keycaps	005-014673
Font option ROM	100-002479
Character ROM	100-002486

Table 1.5 German Field Replaceable Units

FRU	Part No.
D100 Keyboard	005-013687
D200 Keyboard	005-014128
Main printed circuit board (220V, 50Hz):	
without split baud/printer option	005-014533
with split baud/printer option	005-014531
CRT/yoke assembly	005-013701
Keycaps	005-014674
Font option ROM	100-002480
Character ROM	100-002485

Table 1.6 Swedish/Finnish Field Replaceable Units

FRU	Part No.
D100 Keyboard	005-013687
D200 Keyboard	005-014128
Main printed circuit board (220V, 50Hz):	
without split baud/printer option	005-014533
with split baud/printer option	005-014531
CRT/yoke assembly	005-013701
Keycaps	005-014660
Font option ROM	100-002481
Character ROM	100-002483

Table 1.7 Spanish Field Replaceable Units

FRU	Part No.
D100 Keyboard	005-013687
D200 Keyboard	005-014128
Main printed circuit board	
without split baud/printer option:	
120V, 60Hz	005-014529
220V, 50Hz	005-014533
Main printed circuit board	
with split baud/printer option:	
120V, 60Hz	005-013685
220V, 50Hz	005-014531
CRT/yoke assembly	005-013701
Keycaps	005-014661
Font option ROM	100-002478
Character ROM	100-002482

## RELATED DOCUMENTATION

A list of documentation for D100/D200 terminals appears in table 1.8.

Table 1.8 Related Documentation

Affected Assembly	DGC No.	Description
D100/D200 terminals	001-002630	Interconnection diagram
	010-000241	Installation data sheets
	014-000640	User's Manual, D100/D200 Display Terminals
	014-000641	Operator's Manual, D100/D200 Display Terminals
	096-001651	Program listing, Print X exerciser
	015-000082	DTOS Summary
	015-000087	How To Use And Service The DASHER Terminal Tester
D100 Keyboard	001-001574	D100 keyboard schematic
	016-000873	D100 illustrated parts list
D200 Keyboard	001-001695	D200 keyboard schematic
	016-000884	D200 illustrated parts list
Main PC Board	001-002691	Main PCB schematic
	016-000898	Main PCB illustrated parts list
Printer Option	001-002692	Printer option schematic
	016-000938	Printer option illustrated parts list



## CHAPTER 2 HOW TO OPERATE THE TERMINAL

### POWER ON/OFF AND SCREEN BRIGHTNESS

A SINGLE knob on the front of the display unit controls power and CRT screen brightness:

To turn on the power, pull out the knob.

To turn off the power, push in the knob.

To brighten the screen, turn the knob clockwise.

To darken the screen, turn the knob counter-clockwise.

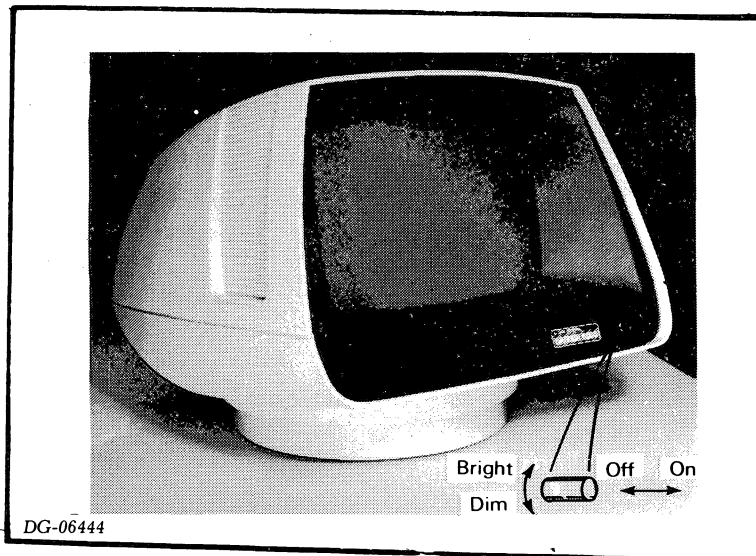

Figure 2.1 Display front panel

When the power is turned on, the self-test automatically checks out the terminal. After about 10 seconds, the cursor (a solid white block) appears in the upper-left corner of the screen, and the terminal is ready to receive commands.

If the cursor fails to appear or the terminal beeps and displays a letter in the top center of the screen, the self-test has found a problem. See "Self Test" on page 5-1 for what to do in this situation.

### ON LINE / OFF LINE MODE

The terminal operates in on-line or off-line mode. These operating modes are selected differently on the D100 and D200 terminals. On the D100 terminal, press the DEL (delete) key while holding down the CMD (command) key. On the D200 terminal, press the ON LINE key while holding down the CMD (command) key. Pressing these keys switches the terminal from one mode to the other. When the terminal is on line, the ON LINE light is lit.

NOTE: On power-up, the terminal automatically enters on-line mode unless the self-test finds a problem or the communications cable is not connected to the terminal.

In off-line mode, information entered on the keyboard is sent directly to the display so that typing on the keyboard is very similar to typing on a typewriter. In this mode the terminal is not part of the computer system.

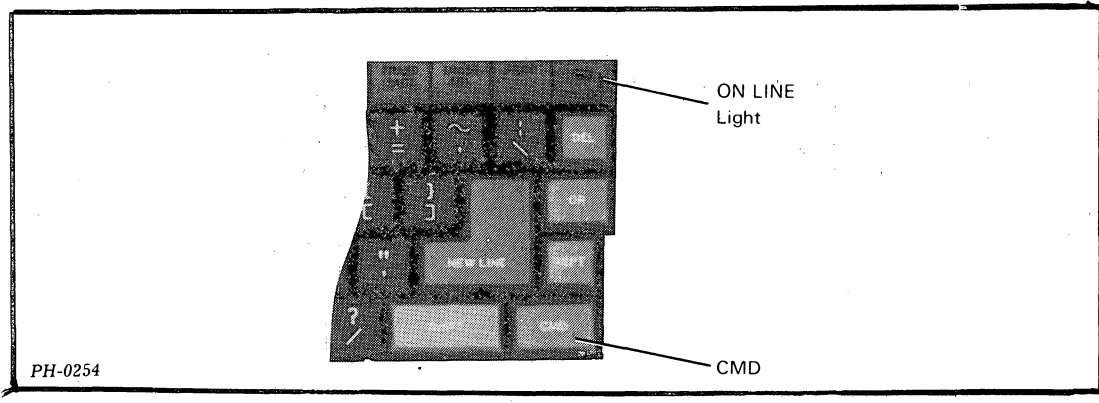

Figure 2.2 D100 on/off line mode control

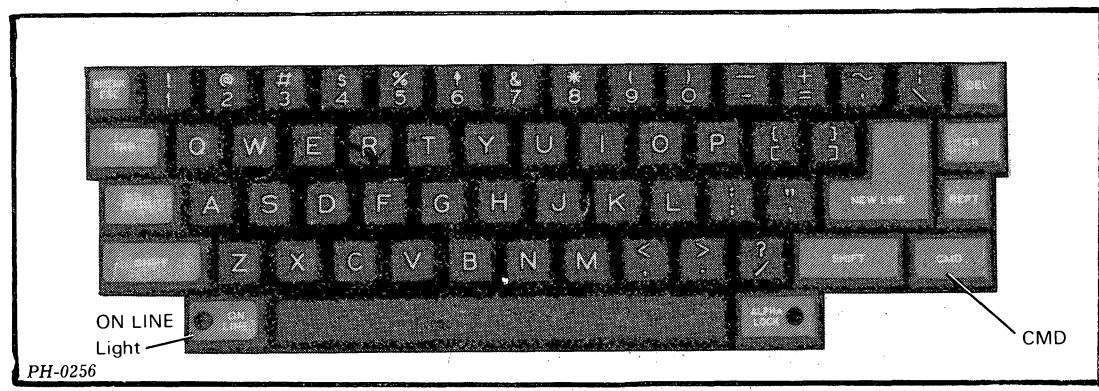

Figure 2.3 D200 on/off line mode control



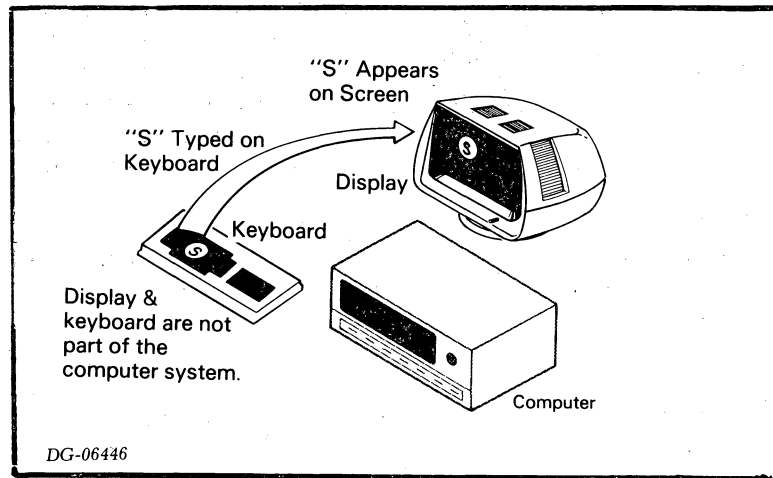

Figure 2.4 Off-line operation

In on-line mode, the keyboard and the display function as two independent units. They become part of the computer system, and the response of the display is controlled by the computer program. Thus, entering a character on the keyboard will not result in the character appearing on the screen unless the computer program sends (echoes) that character to the display. Similarly, typing a control character when on line, will have no effect unless a program defines an effect for the particular control character.

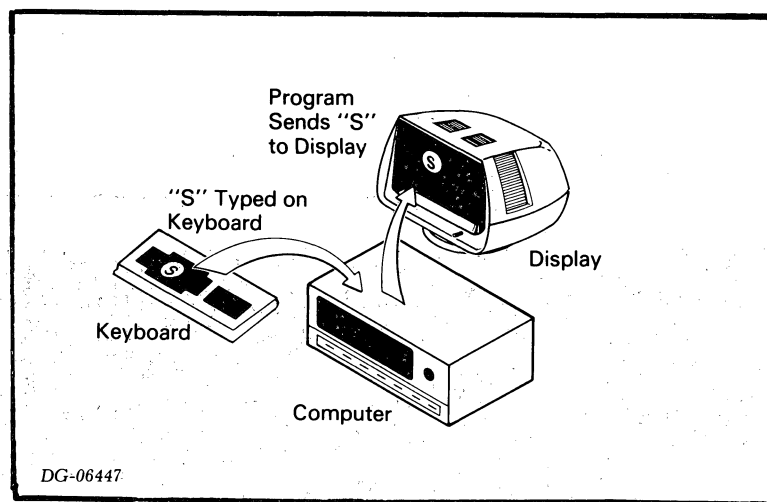

Figure 2.5 On-line operation

## CURSOR LOCK/UNLOCK MODE

The D100 cursor/numeric keypad has two operating modes: cursor lock and cursor unlock. In cursor lock mode, pressing a key generates the code for the associated cursor function. In cursor unlock mode, pressing a key generates the code for the numeric function, and pressing a key together with the CMD key generates the code for the associated cursor function.

To select cursor lock mode, press CMD=9. The light above the keypad turns on to indicate that the keypad is in cursor lock mode. When the terminal is powered-up, it automatically enters cursor lock mode. To select cursor unlock mode, press CMD=7.

## DISPLAY COMMANDS

Display commands assign attributes to characters, position the cursor and perform screen management functions (erase page, roll enable, etc.). Table 2.1 lists the display commands, their ASCII codes, off-line effect, and ways of generating the commands via the keyboard. Note that the effects listed in the table are true only for off-line operation. On line, the effects depend on the response of the computer program.

NOTE: Two display commands - START REVERSE VIDEO and END REVERSE VIDEO - cannot be generated from the keyboard.

Table 2.1 Display commands

Command	Octal Code	To Produce On D100/D200 Keyboard	Off-Line Effect
Carriage Return	015	CR, CTRL=CR, SHIFT=CR, CTRL=SHIFT=CR, CTRL=M, CTRL=SHIFT=M	Moves cursor to the beginning of the current line.
New Line	012	NEW LINE, CTRL=NEW LINE, CTRL=SHIFT=NEW LINE, CTRL=J, or CTRL=SHIFT=J	Moves cursor to the beginning of the next line.
Cursor Up	027	↑, CTRL=W or CTRL=SHIFT=W **	Moves cursor up one line.
Cursor Right	030	→, CTRL=X or CTRL=SHIFT=X **	Moves cursor right one character
Cursor Left	031	←, CTRL=Y or CTRL=SHIFT=Y **	Moves cursor left one character.
Cursor Down	032	↓, CTRL=Z or CTRL=SHIFT=Z **	Moves cursor down one line.

Table 2.1 Display commands (continued)

Command	Octal Code	To Produce On D100/D200 Keyboard	Off-Line Effect
Home	010	HOME ** CTRL-H or CTRL-SHIFT-H	Moves cursor to the upper-left corner of the screen.
Write Cursor Address	020	CTRL-P or CTRL-SHIFT-P	Forces display to use the next two codes received as the cursor's new column and line address, respectively. After second code is received, cursor moves to specified position.
Read Cursor Address	005	CTRL-E or CTRL-SHIFT-E	Has no off-line effect.
Roll Enable	022	CTRL-R or CTRL-SHIFT-R	Enables roll mode. The screen rolls up one line each time the cursor is moved beyond the last line.
Roll Disable	023	CTRL-S or CTRL-SHIFT-S	Disables roll mode. The cursor moves to the top of the screen each time it is moved below the bottom line.
Erase To End Of Line	013	CMD-ERASE EOL (D100 only), ERASE EOL (D200 only), CTRL-K or CTRL-SHIFT-K	Erases displayed characters from present cursor position to the end of the line.
Erase Page	014	CMD-ERASE PAGE (D100 only), ERASE PAGE (D200 only), CTRL-L or CTRL-SHIFT-L	Erases screen.
Enable Blink	003	CTRL-C or CTRL-SHIFT-C	Enables screen's ability to blink characters.
Disable Blink	004	CTRL-D or CTRL-SHIFT-D	Disables screen's ability to blink characters.

Table 2.1 Display commands (continued)

Command	Octal Code	To Produce On D100/D200 Keyboard	Off-Line Effect
Start Blink	016	CTRL=N or CTRL-SHIFT=N	Turns on blink attribute for succeeding characters sent to the display.
End Blink	017	CTRL=O or CTRL-SHIFT=O	Turns off blink attribute for succeeding characters sent to the display.
Start Dim	034	CTRL=\	Turns on dim attribute for succeeding characters sent to the display.
End Dim	035	CTRL=]	Turns off dim attribute for succeeding characters sent to the display.
Start Underscore	024	CTRL=T or CTRL-SHIFT=T	Turns on underscore attribute for succeeding characters sent to the display.
End Underscore	025	CTRL=U or CTRL-SHIFT=U	Turns off underscore attribute for succeeding characters sent to the display.
Start Reverse Video	036 104 *	Cannot be generated from keyboard	Turns on reverse video attribute for succeeding characters sent to the display.
End Reverse Video	036 105 *	Cannot be generated from keyboard	Turns off reverse video attribute for succeeding characters sent to the display.
Bell	007	CTRL=G or CTRL-SHIFT=G	Sounds a beep.

\* Two-code sequence.

\*\* On the D100 keyboard, pressing a HOME, →, ←, ↑, or ↓ key moves the cursor only when the keyboard is in cursor lock mode. In cursor unlock mode, the CMD key must be pressed together with each of these keys to move the cursor.

## TERMINAL IDENTIFICATION/DIAGNOSTIC COMMANDS

The following commands allow a computer to identify and test D100 and D200 terminals: MODEL REPORT REQUEST, ENTER REMOTE TEST, and EXIT REMOTE TEST. Table 2.2 summarizes these commands. Note that none of them can be generated via the keyboard.

Table 2.2 Terminal identification/diagnostic commands

Command	Octal Code	Function														
Model Report Request	036 103	<p>Instructs the terminal to send back the following six-code sequence.</p> <p>036 - Header code                      157 - Header code                      043 - Indicates report request data follows                      041 - Indicates D100/D200 series terminal                      XXX - Configuration code (see below)                      YYY - Firmware code</p> <p>Meaning of the configuration code (XXX)</p> <table border="1" data-bbox="750 1003 1386 1482"> <thead> <tr> <th>Bit Numbers</th> <th>Meaning</th> </tr> </thead> <tbody> <tr> <td>6</td> <td>Always 1.</td> </tr> <tr> <td>5</td> <td>1 indicates 50Hz operation is selected; 0 indicates 60Hz operation is selected.</td> </tr> <tr> <td>4</td> <td>1 indicates the <i>split baud and printer option</i> is not present; 0 indicates the option is present.</td> </tr> <tr> <td>3</td> <td>If bit 4 is 0, 0 indicates the printer is not ready; 1 indicates the printer is ready.</td> </tr> <tr> <td>2</td> <td>0 indicates the American character font is installed; 1 indicates one of the other character fonts is installed.</td> </tr> <tr> <td>1, 0</td> <td>01 indicates the D100 keyboard is present; 10 indicates the D200 keyboard is present; 00 indicates no keyboard is present.</td> </tr> </tbody> </table>	Bit Numbers	Meaning	6	Always 1.	5	1 indicates 50Hz operation is selected; 0 indicates 60Hz operation is selected.	4	1 indicates the <i>split baud and printer option</i> is not present; 0 indicates the option is present.	3	If bit 4 is 0, 0 indicates the printer is not ready; 1 indicates the printer is ready.	2	0 indicates the American character font is installed; 1 indicates one of the other character fonts is installed.	1, 0	01 indicates the D100 keyboard is present; 10 indicates the D200 keyboard is present; 00 indicates no keyboard is present.
Bit Numbers	Meaning															
6	Always 1.															
5	1 indicates 50Hz operation is selected; 0 indicates 60Hz operation is selected.															
4	1 indicates the <i>split baud and printer option</i> is not present; 0 indicates the option is present.															
3	If bit 4 is 0, 0 indicates the printer is not ready; 1 indicates the printer is ready.															
2	0 indicates the American character font is installed; 1 indicates one of the other character fonts is installed.															
1, 0	01 indicates the D100 keyboard is present; 10 indicates the D200 keyboard is present; 00 indicates no keyboard is present.															
Enter Remote Test	036 101	Places terminal in diagnostic mode, thus allowing it to receive programs that will be executed by the terminal's microprocessor														
Exit Remote Test	036 102	Terminates diagnostic mode. After receiving this command, terminal automatically executes self-test, providing the terminal was in diagnostic mode														

## PRINT COMMANDS

Two print commands - PRINT and PRINT FORM - enable local hard-copy generation of information when the printer option is installed. Table 2.3 summarizes these commands.

Table 2.3 Print commands

Command	Octal Code	To Produce On D100/D200 Keyboard	Off-line Effect
Print Page	036 021	D100: CTRL-Q, CTRL-SHIFT-Q or CMD-\ D200: CMD-PRINT	Prints all information on screen from the beginning of the current line to the end of the screen. *
Print Form	036 001	D100: CTRL-A, SHIFT-CTRL-A or CMD-SHIFT-\ D200: CMD-SHIFT-PRINT	Prints all information displayed at full intensity from the beginning of the current line to the end of the screen. Dimmed characters are printed as spaces. *

\* To terminate a print operation from the keyboard, enter CMD-CR.

## USER FUNCTION CODES

User function codes are two-codes sequences that a computer program may define in any way. The terminal's response to these codes depends on the programs's interpretation of them.

D100 keyboards can transmit 35 unique user function codes; D200 keyboards can transmit 75. The first (header) code in each sequence is Record Separator (octal 36). Figures 2.6 and 2.7 define the location of the user function keys on the D100 and D200 keyboards, respectively, and table 2.4 lists the codes sequences that the terminals generate.

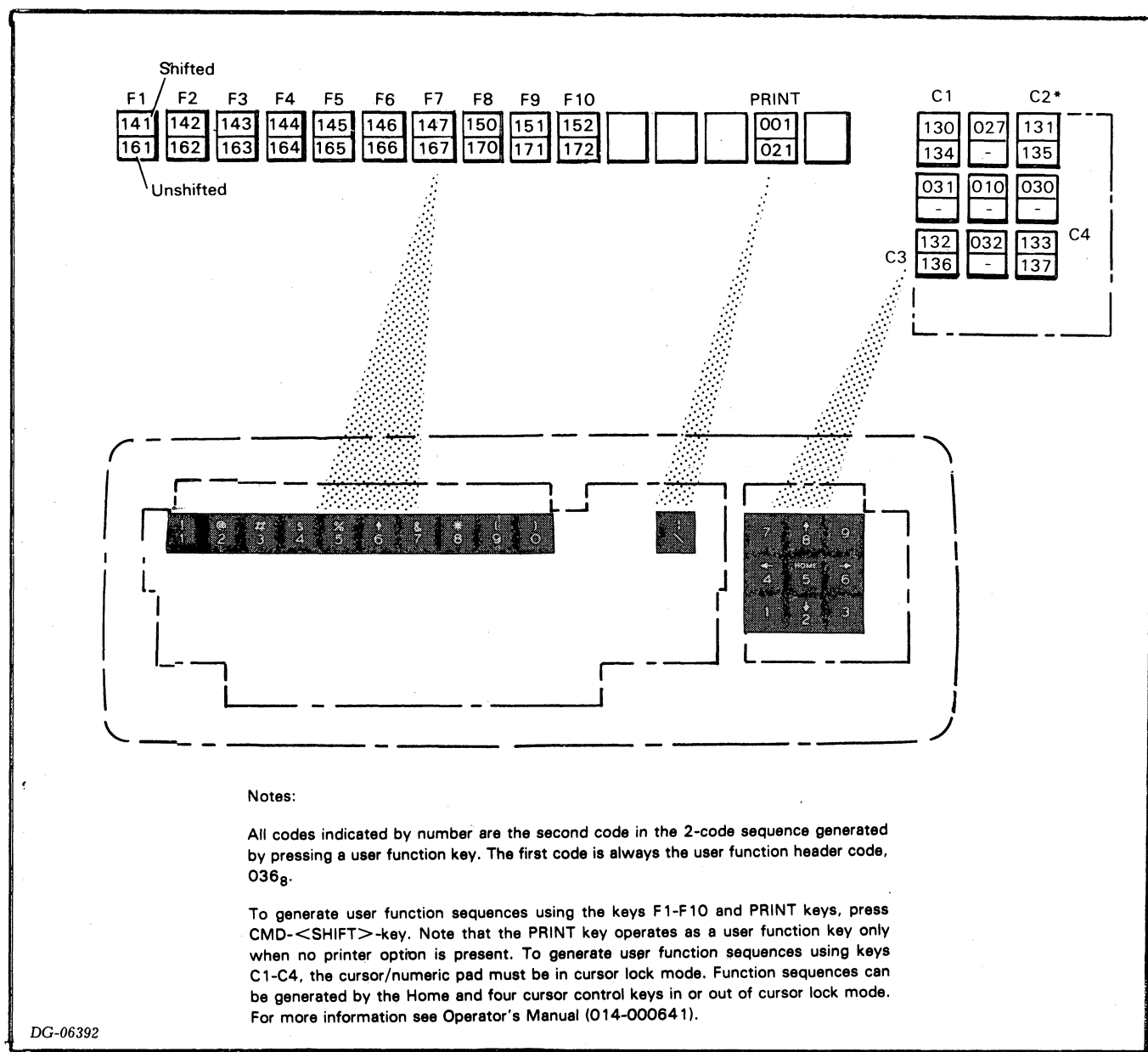

DG-06392

Figure 2.6 D100 user function keys

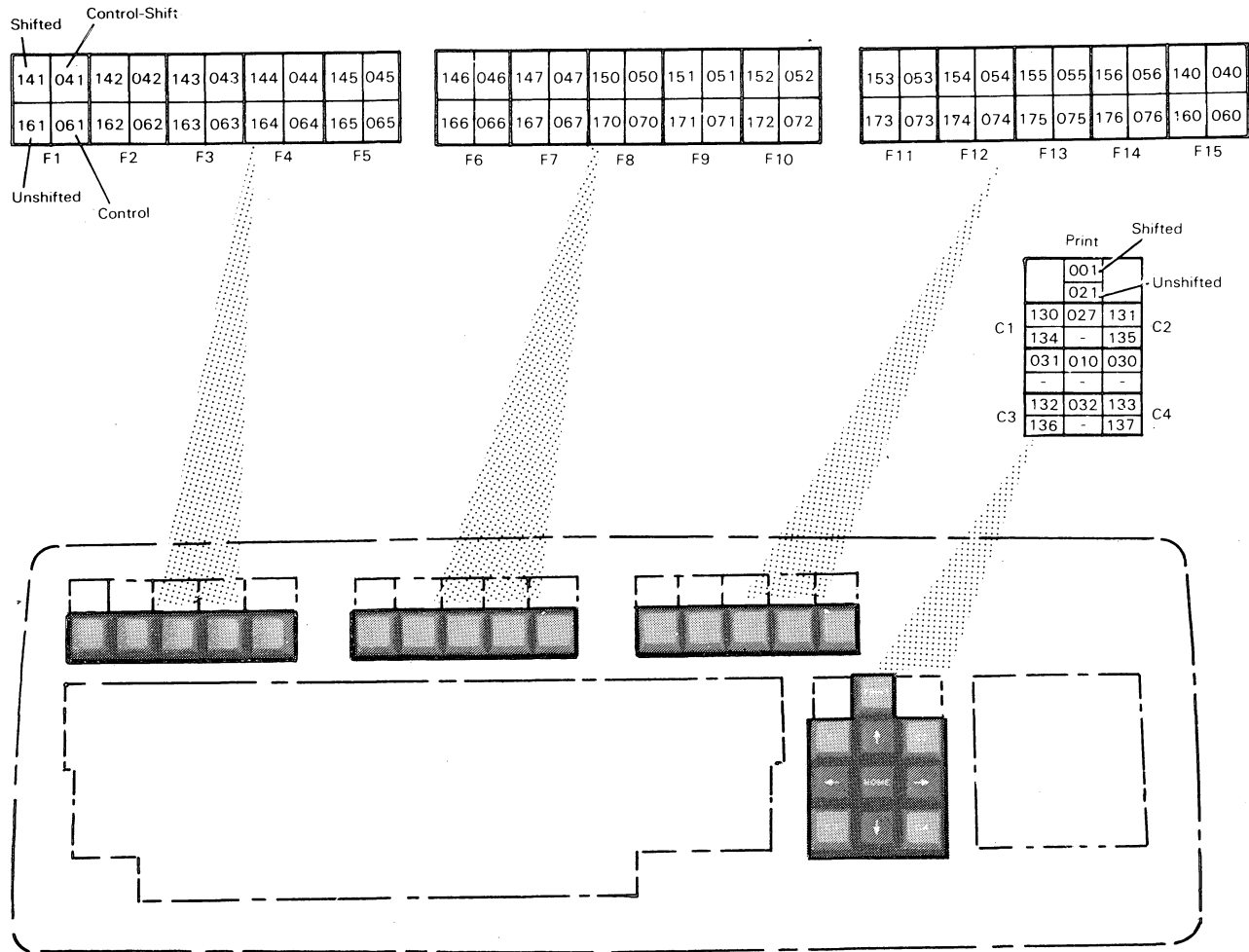

Notes:

All codes indicated by number are the second code in the 2-code sequence generated by pressing a user function key. The first code is always the user function header code, 036<sub>B</sub>.

To generate the function codes associated with keys F1-F15 and C1-C4, press <CTRL>-<SHIFT>-key. To generate the function codes associated with the PRINT key, press CMD-<SHIFT>-PRINT. For more information see Operator's Manual (014-000641).

DG-06393

Figure 2.7 D200 user function keys



Table 2.4 Code sequences generated by D100/D200 terminals

CODE SEQUENCE (octal)	D100 Keyboard	D200 Keyboard
036.001	CMD-SHIFT-\	CMD-SHIFT-PRINT
036.010	SHIFT-HOME *	SHIFT-MODE-HOME
036.021	CMD-\	CMD-PRINT
036.027	SHIFT-] *	SHIFT-]
036.030	SHIFT-→ *	SHIFT-→
036.031	SHIFT-← *	SHIFT-←
036.032	SHIFT-^ *	SHIFT-^
036.040	-	CTRL-SHIFT-F15
036.041	-	CTRL-SHIFT-F1
036.042	-	CTRL-SHIFT-F2
036.043	-	CTRL-SHIFT-F3
036.044	-	CTRL-SHIFT-F4
036.045	-	CTRL-SHIFT-F5
036.046	-	CTRL-SHIFT-F6
036.047	-	CTRL-SHIFT-F7
036.050	-	CTRL-SHIFT-F8
036.051	-	CTRL-SHIFT-F9
036.052	-	CTRL-SHIFT-F10
036.053	-	CTRL-SHIFT-F11
036.054	-	CTRL-SHIFT-F12
036.055	-	CTRL-SHIFT-F13
036.056	-	CTRL-SHIFT-F14
036.060	-	CTRL-F15
036.061	-	CTRL-F1
036.062	-	CTRL-F2
036.063	-	CTRL-F3
036.064	-	CTRL-F4
036.065	-	CTRL-F5
036.066	-	CTRL-F6
036.067	-	CTRL-F7
036.070	-	CTRL-F8
036.071	-	CTRL-F9
036.072	-	CTRL-F10
036.073	-	CTRL-F11
036.074	-	CTRL-F12

CODE SEQUENCE (octal)	D100 Keyboard	D200 Keyboard
036.075	-	CTRL-F13
036.076	-	CTRL-F14
036.130	SHIFT-7 *	SHIFT-C1
036.131	SHIFT-9 *	SHIFT-C2
036.132	SHIFT-1 *	SHIFT-C3
036.133	SHIFT-3 *	SHIFT-C4
036.134	7 *	C1
036.135	9 *	C2
036.136	1 *	C3
036.137	3 *	C4
036.140	-	SHIFT-F15
036.141	CMD-SHIFT-1	SHIFT-F1
036.142	CMD-SHIFT-2	SHIFT-F2
036.143	CMD-SHIFT-3	SHIFT-F3
036.144	CMD-SHIFT-4	SHIFT-F4
036.145	CMD-SHIFT-5	SHIFT-F5
036.146	CMD-SHIFT-6	SHIFT-F6
036.147	CMD-SHIFT-7	SHIFT-F7
036.150	CMD-SHIFT-8	SHIFT-F8
036.151	CMD-SHIFT-9	SHIFT-F9
036.152	CMD-SHIFT-0	SHIFT-F10
036.153	-	SHIFT-F11
036.154	-	SHIFT-F12
036.155	-	SHIFT-F13
036.156	-	SHIFT-F14
036.160	-	F15
036.161	CMD-1	F1
036.162	CMD-2	F2
036.163	CMD-3	F3
036.164	CMD-4	F4
036.165	CMD-5	F5
036.166	CMD-6	F6
036.167	CMD-7	F7
036.170	CMD-8	F8
036.171	CMD-9	F9
036.172	CMD-0	F10
036.173	-	F11
036.174	-	F12
036.175	-	F13
036.176	-	F14

\* On cursor/numeric keypad, keypad must be in cursor lock mode. If the keypad is in cursor unlock mode, press the CMD key also. (See DASHER D100/D200 Operator's Manual, DGC 014-000641.) All other D100 code sequences are generated by the main keypad.



Data General Corporation (DGC) has prepared this manual for use by DGC personnel and customers as a guide to the proper installation, operation, and maintenance of DGC equipment and software. The drawings and specifications contained herein are the property of DGC and shall neither be reproduced in whole or in part without DGC's prior written approval nor be implied to grant any license to make, use, or sell equipment manufactured in accordance herewith.

## PART 2

### INSTALLING AND TROUBLESHOOTING



## CHAPTER 3 INSTALLATION PROCEDURES

Installing a D100/D200 terminal consists of the following steps:

- Choosing a site for the terminal.
- Unpacking the terminal.
- Tailoring the communications interface.
- Tailoring the optional printer interface, when present.

Perform each step as described in this chapter. When the terminal is installed, check its operation following the troubleshooting flowchart in chapter 4.

### CHOOSING A SITE

Choose a site for the DASHER D100/D200 terminal using the specifications shown in figure 3.1 and table 3.1.

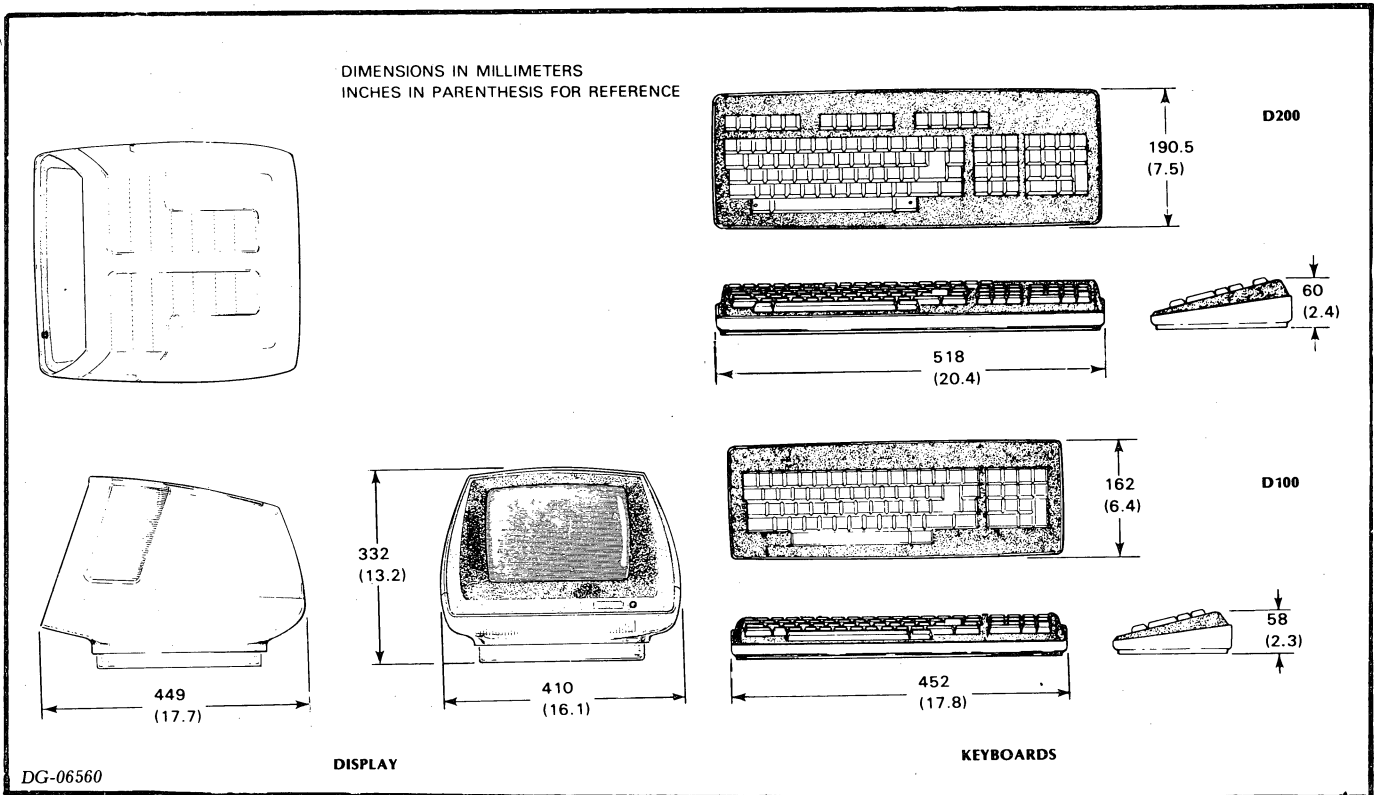

Figure 3.1 Terminal dimensions

**Table 3.1 Terminal specifications**

<b>DIMENSIONS:</b>				<b>POWER REQUIREMENTS:</b>			
Display				(Domestic)			
	<b>Width</b>	<b>Depth</b>	<b>Height</b>	<b>Voltage:</b>	85-132 VAC		
Millimeters	410	449	332	<b>Freq.:</b>	47-63 HZ		
Inches	16.1	17.7	13.2	<b>Current:</b>	1.5 Amps at 120 VAC, 60 Hz		
D100 Keyboard:				<b>Startup Surge:</b>	2 Amps at 120 VAC, 60 Hz for 1 cycle		
				(Export)			
	<b>Width</b>	<b>Depth</b>	<b>Height</b>	<b>Voltage:</b>	187-264 VAC		
Millimeters	452	162	58	<b>Freq.:</b>	47-63 Hz		
Inches	17.8	6.4	2.3	<b>Current:</b>	0.75 Amps at 240 VAC, 50 Hz		
D200 Keyboard:				<b>Startup Surge:</b>	2 Amps at 240 VAC, 50 Hz for 1 cycle		
	<b>Width</b>	<b>Depth</b>	<b>Height</b>	<b>OPERATING ENVIRONMENT:</b>			
Millimeters	518	190.5	60	<b>Temperature (max)</b>	0° - 45°C 32° - 113°F		
Inches	20.4	7.5	2.4	<b>Humidity (max)</b>	10% - 90% non-condensing		
				<b>Altitude</b>	3048 m 10,000 ft		
<b>WEIGHT:</b>				<b>CABLES:</b>			
	<b>kg</b>	<b>lbs</b>		Primary Power			
Display:	10	22		<b>Length</b>	<b>Conn</b>	<b>Mating Conn</b>	
D100 keyboard:	1.1	2.4		<b>Domestic 60Hz</b>	1.8m(6')	5-15P	5-15R
D200 keyboard:	1.6	3.5		<b>Export 50Hz</b>	1.8m(6')	—	—
<b>HEAT OUTPUT (Max.):</b>							
	<b>Watts</b>	<b>BTU/hr</b>					
	50	171					

DG-06573

## UNPACKING

Unpack the display and keyboard as shown in figure 3.2. Then, plug the cable attached to the keyboard into the receptacle provided at the rear of the display unit. See Figure 3.3.

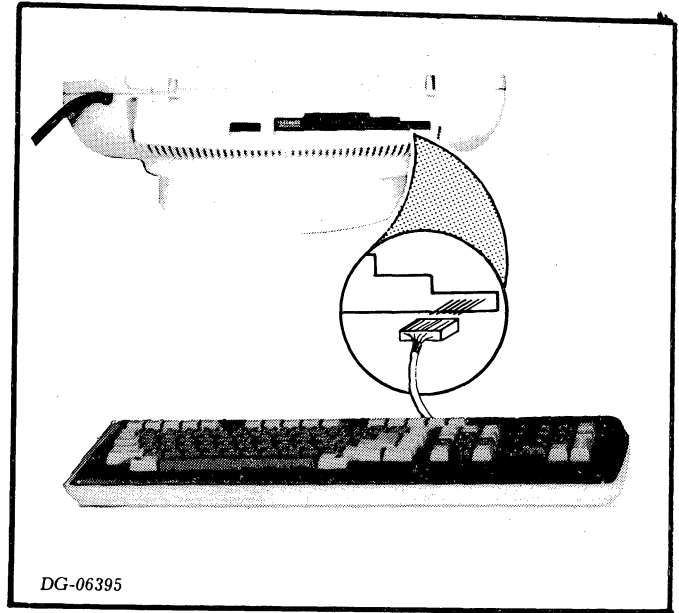
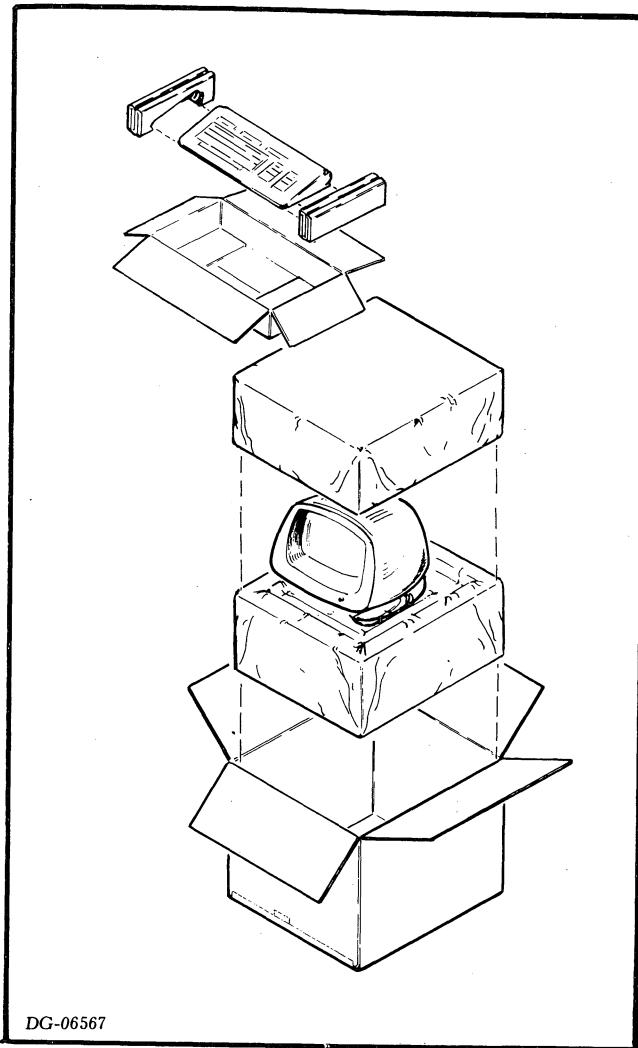

Figure 3.2 Unpacking the terminal      Figure 3.3 Plugging in the keyboard

## COMMUNICATIONS INTERFACE TAILORING

To tailor the communications interface, select the parity and data transmission rate (baud) for the terminal. Figure 3.4 locates the switches that are used for this purpose.

If the split baud portion of the optional printer interface will be used, follow the directions in Figure 3.4 for receive data; i.e., the data received by the terminal. Then, refer to Figure 3.5 for the location of the switches that enable the split baud feature and select the data transmission rate for transmit data.

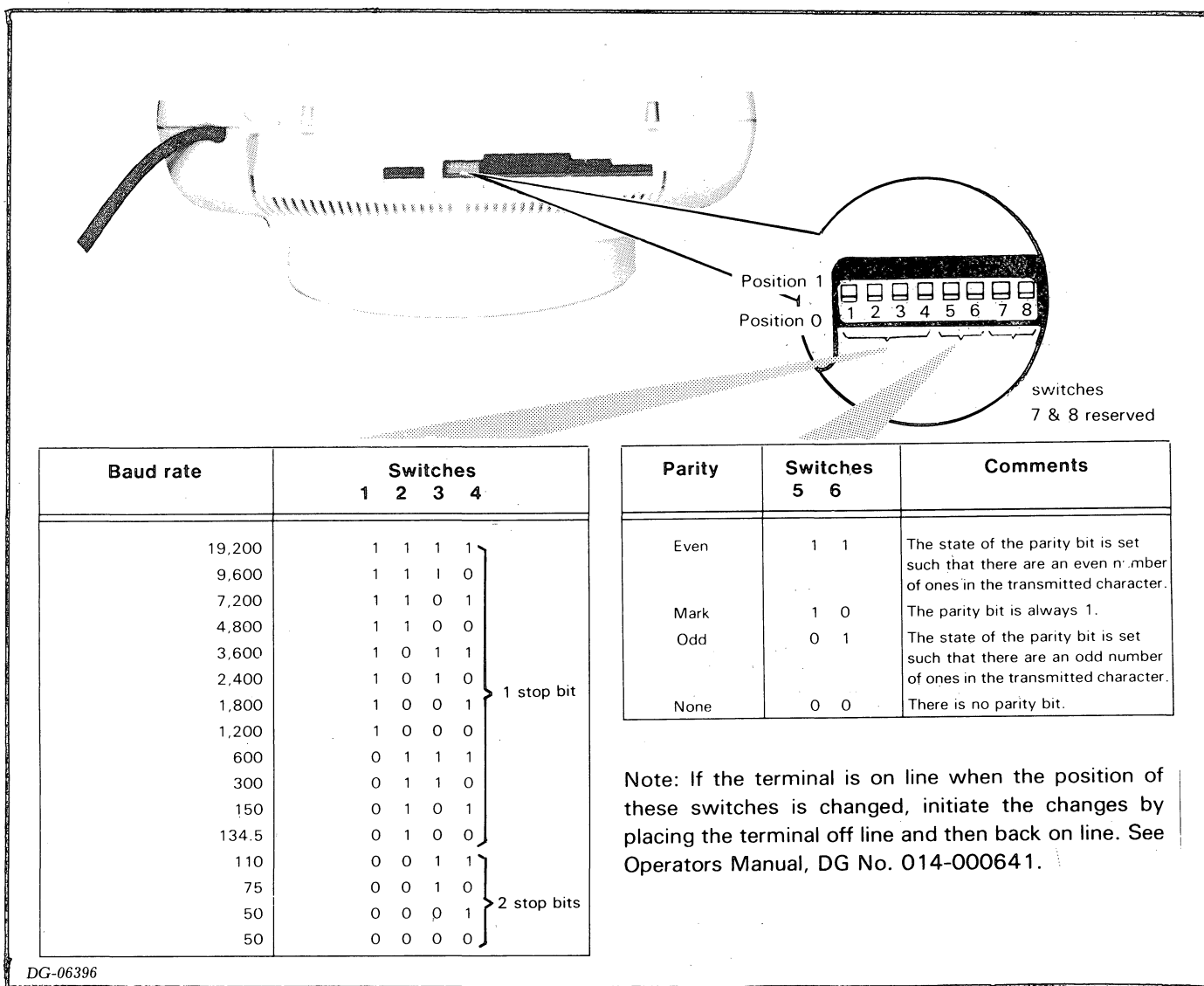

Figure 3.4 baud rate and parity switches



## PRINTER INTERFACE TAILORING

To tailor the printer interface, select the transmission rate for the printer as shown in Figure 3.5. Consult your printer manual to select the appropriate transmission rate. If the split baud feature is enabled, the option baud switches define both the display's transmit rate as well as the terminal-to-printer transmission rate.

**CAUTION** Hazardous voltages. Wait at least 5 minutes after power-down before opening case.

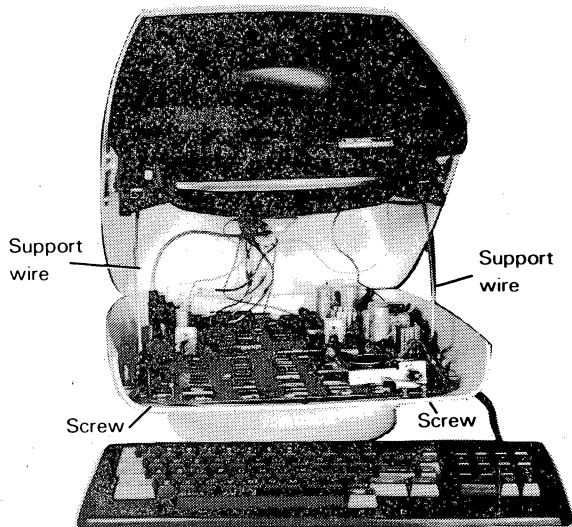

Split baud	Switch 1
Enable	0
Disable	1

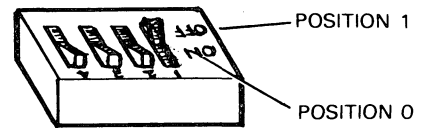

Printer Interface and/or Display Transmit Baud Rate (Split Baud)	Switches 2 3 4
4800	1 1 1
3600	1 1 0
2400	1 0 1
1800	1 0 0
1200	0 1 1
600	0 1 0
300	0 0 1
110	0 0 0

To access the switches, see "Opening and Closing the Display Case," chapter 8.

DG-06386

Figure 3.5 Optional split baud switches

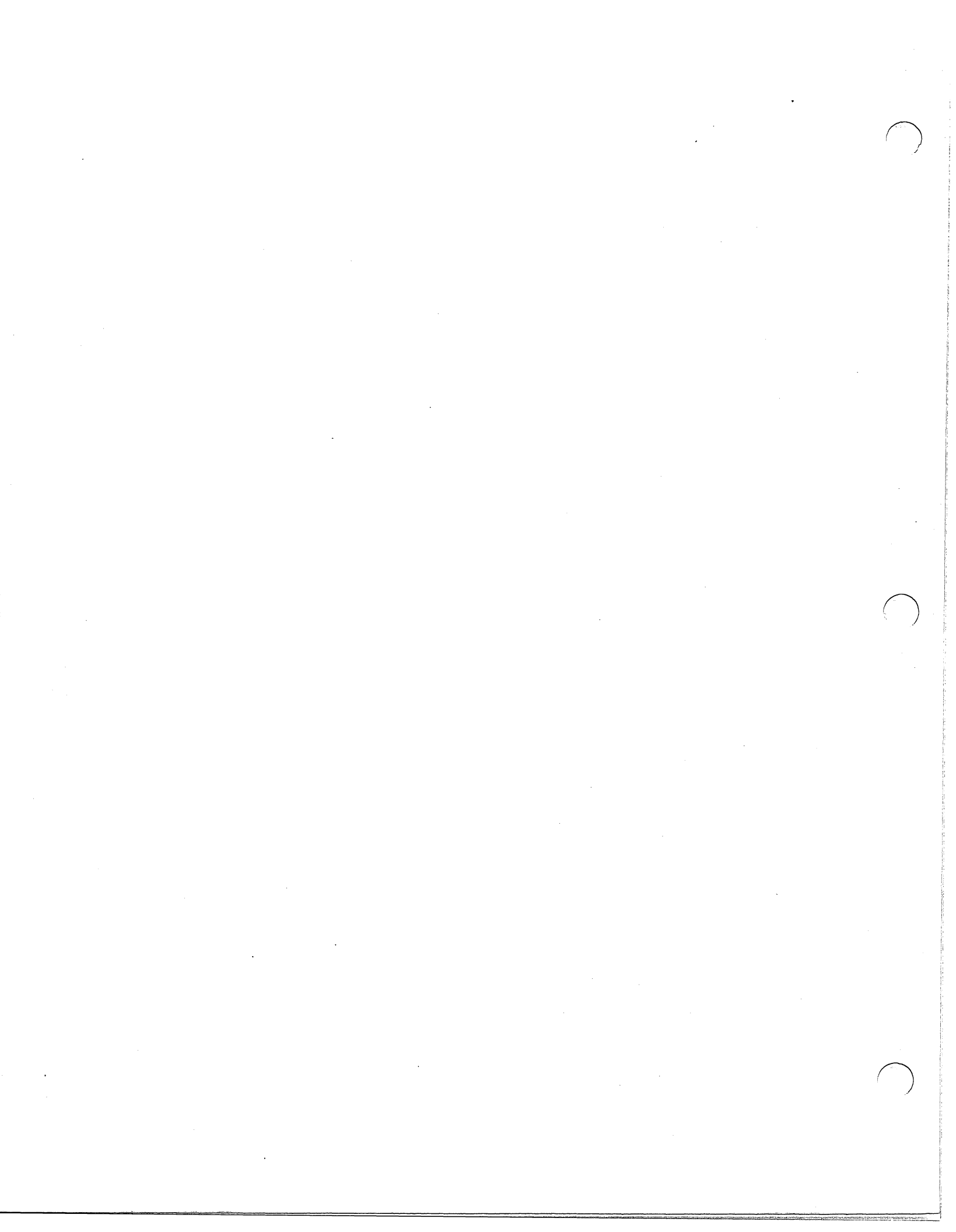

## CHAPTER 4 INTRODUCTION TO TROUBLESHOOTING

This part of the manual contains procedures for troubleshooting a D100 or D200 terminal. These procedures are for use during the initial checkout of a newly installed terminal or the repair of a previously installed terminal.

While these situations are different, many of the procedures required to perform both initial checkout and repair are the same, as shown in the troubleshooting flowchart, figure 4.1. This flowchart presents a logical sequence of fault isolation, referencing procedures in chapters 5 and 6. These chapters contain step-by-step procedures for detecting faulty field replaceable units (FRUs) and for checking a terminal's operation. Actual procedures for replacing and adjusting FRUs are given in part 4.

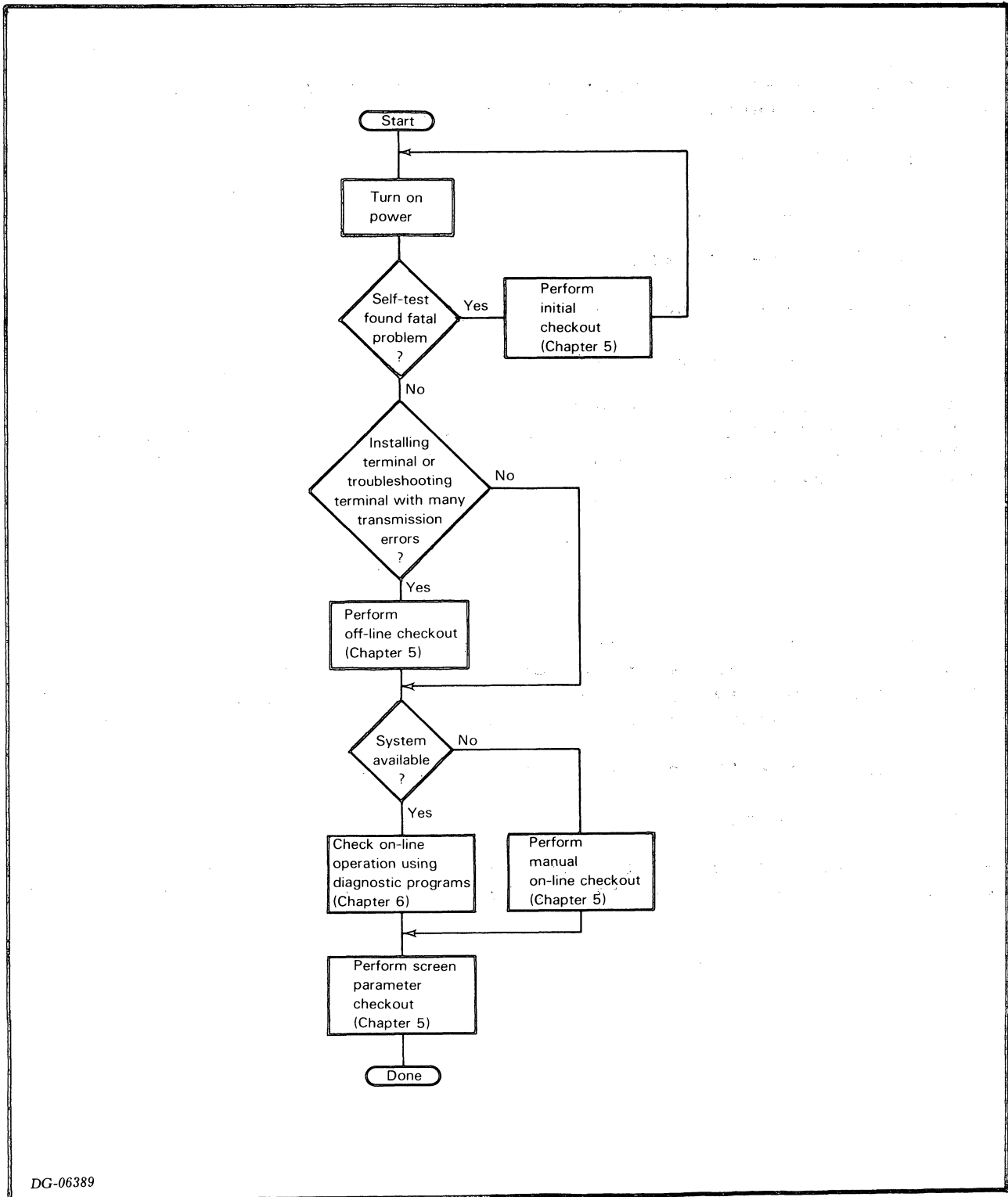

DG-06389

Figure 4.1 Troubleshooting flowchart

## CHAPTER 5 MANUAL TROUBLESHOOTING

This chapter presents the five different procedures for verifying the operation of the terminal or isolating failing FRUs in the terminal:

- Self-test
- Initial checkout
- Off-line checkout
- Manual on-line checkout
- Screen parameter checkout

Each procedure can be performed without monopolizing the rest of the system. Carry them out in the order prescribed by the troubleshooting flowchart, figure 4.1. When you find a failing unit, replace it following the replacement procedure given in chapter 8.

### SELF-TEST

Whenever the terminal is powered up, the terminal automatically runs a 10 second self-test to verify the proper operation of the control logic and the presence of the keyboard. While the test runs, the screen is blank. After about 10 seconds, the screen displays the results of the test.

Check the terminal with the self-test as follows:

1. Turn on the power.
2. After 10 seconds, check the screen for the results of the test. Carry out the steps given in table 5.1 for the appropriate result.

Table 5.1 Troubleshooting with the self-test

Result Displayed	Corrective Action								
Cursor in home position.*	None. Self-test did not find any problems. Perform the next checkout procedure indicated by the flowchart.								
Single character at top center of screen.	<p>Carry out the procedure below for the character displayed:</p> <table border="0" data-bbox="525 699 1455 1171"> <thead> <tr> <th data-bbox="525 699 702 730">Character</th> <th data-bbox="987 699 1164 730">Procedure</th> </tr> </thead> <tbody> <tr> <td data-bbox="583 762 607 793">A</td> <td data-bbox="773 762 1455 825">Reseat keyboard cable in receptacle at rear of display.</td> </tr> <tr> <td data-bbox="525 856 718 951">B, D, F, H, J, L, N, P, R, T, V, X, Z, \, ^</td> <td data-bbox="773 856 1197 888">Replace circuit board.</td> </tr> <tr> <td data-bbox="525 982 718 1077">C, E, G, I, K, M, O, Q, S, U, W, Y, [, =</td> <td data-bbox="773 982 1455 1171">Reseat keyboard cable connector in receptacle at rear of display. If self-test still displays one of the characters listed, replace the keyboard. If this does not correct problem, replace the circuit board.</td> </tr> </tbody> </table>	Character	Procedure	A	Reseat keyboard cable in receptacle at rear of display.	B, D, F, H, J, L, N, P, R, T, V, X, Z, \, ^	Replace circuit board.	C, E, G, I, K, M, O, Q, S, U, W, Y, [, =	Reseat keyboard cable connector in receptacle at rear of display. If self-test still displays one of the characters listed, replace the keyboard. If this does not correct problem, replace the circuit board.
Character	Procedure								
A	Reseat keyboard cable in receptacle at rear of display.								
B, D, F, H, J, L, N, P, R, T, V, X, Z, \, ^	Replace circuit board.								
C, E, G, I, K, M, O, Q, S, U, W, Y, [, =	Reseat keyboard cable connector in receptacle at rear of display. If self-test still displays one of the characters listed, replace the keyboard. If this does not correct problem, replace the circuit board.								
None - screen still blank	Turn up intensity. If screen is still blank, replace the circuit board. If this does not correct the problem, replace the CRT/yoke assembly.								

\* A white block located at the upper-left corner of the screen.

## OFF-LINE CHECKOUT

This checkout verifies the terminal's off-line response to the display commands. It should be performed whenever you install a terminal or troubleshoot a terminal with many transmission errors.

Before performing this checkout make sure that the power supplied by the selected wall outlet is compatible with the power requirements listed on the label on the rear of the display unit.

Check the off-line operation as follows:

1. Disconnect the communications cable and the printer cable (if present) from the rear of the display unit (see figure 5.1).
2. Turn the power on. Adjust the intensity until the cursor is visible.
3. Carry out the procedures given in table 5.2. If you do NOT get the expected result, replace the keyboard. Repeat the procedure that produced the unexpected result. If you get the expected result, continue with the checkout; otherwise, reinstall the keyboard and replace the circuit board.

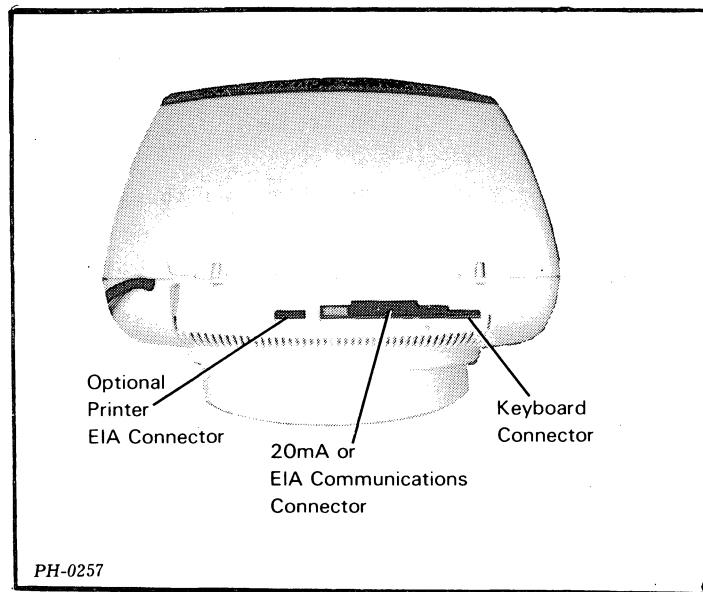

Figure 5.1 Connectors

Table 5.2 Off-line checkout

Procedure	Expected Result
1. Check On Line light.	On Line light is off.
2. Press Alpha Lock key.	Alpha Lock light goes on.
3. Enter some text.	Text appears in upper case.
4. Press Alpha Lock key.	Alpha lock light goes off.
5. Enter some text.	Text appears in lower case unless SHIFT key is used.
6. Press CTRL-G.	Terminal beeps.
7. Press CTRL-T and enter some text.	Text appears underscored.
8. Press CTRL-\ and enter some text.	Text appears dimmed and underscored.
9. Press CTRL-C CTRL-N and enter some text.	Text appears dimmed, underscored, and blinking.
10. Press CTRL-U and enter some text.	Underscore does not appear under new text, but remains under old text.
11. Press CTRL-] and enter old some text.	New text is brightly displayed, but old text remains dim.
12. Press CTRL-O and enter some text.	New text does not blink, but old text continues to blink.
13. Press CTRL-D	All text stops blinking.
14. Press the cursor control keys that have arrows on them. *	Cursor moves in the direction of arrow on keycap.
15. Press HOME. *	Cursor moves to upper-left corner of screen.
16. Press CTRL-S, enter some text, and repeatedly press NEW LINE.	Cursor moves to bottom of screen, then jumps to top and continues moving downward; text remains unchanged.
17. Press CTRL-R and repeatedly press NEW LINE.	Cursor moves to bottom of screen, then text moves up one line each time NEW LINE is pressed.
18. Press CTRL-T CTRL-\ CTRL-C CTRL-N and enter some text.	Text appears underscored, dimmed, and blinking.
19. Press CTRL-L and enter some text.	Screen clears and new text appears and it is NOT underscored, dimmed, or blinking.
20. Move cursor to middle of old text and press ERASE EOL.	Text from cursor position to end of line (inclusive) is erased.

\* See "Cursor Lock/Unlock Mode," page 2-4 for how to activate the cursor controls.



4. If the terminal has the split baud/printer option and a printer is available, do as follows:
  - Make sure the printer interface on the circuit board is tailored correctly (see figure 3.5).
  - Plug the printer's EIA cable into the correct receptacle at the rear of the terminal and turn on the printer (see figure 5.1).
  - Carry out the procedures given in table 5.3. If you do NOT get the expected result, replace the circuit board and repeat the procedure that produced the unexpected result. If you still do NOT get the expected result, reinstall the original circuit board and troubleshoot the printer (see the documentation for the appropriate printer).
5. Plug the communications cable into the EIA/CURRENT LOOP receptacle at the rear of the terminal.
6. If the computer system is available for running terminal test programs, go to chapter 6, "Diagnostic Testing"; otherwise, perform the manual on-line checkout that follows.

Table 5.3 Off-line printer checkout

Procedure	Expected Result
Enter some text, move cursor to middle of text, and either press CTRL-Q on a D100 terminal or CMD-PRINT on a D200 terminal.	Text is printed, starting with beginning of line containing cursor.
Repeat above step and press CMD-CARRIAGE RETURN while text is printing.	Printing stops when CMD-CARRIAGE RETURN is pressed.
Enter some text, move cursor to middle of text, and either press CTRL-A on a D100 terminal or CMD-SHIFT-PRINT on a D200 terminal.	All characters displayed at full intensity are printed, starting with beginning of line containing cursor. Dimmed characters are printed as spaces.

## MANUAL ON-LINE CHECKOUT

This checkout verifies the terminal's on-line operation without tying up the system. It should be performed whenever the system is NOT available for running terminal test programs. If the system is available, go to chapter 6, "Diagnostic Testing," to check on-line operation.

1. Make sure the communications cable is plugged into the EIA/CURRENT LOOP receptacle at the rear of the terminal.
2. Make sure the communications interface on the circuit board is compatible with the host computer (see figure 3.4).
3. Turn on the terminal.
4. Turn up the intensity so that you can see the cursor.
5. Make sure the host computer contains an echo program that returns codes to the terminal when data is entered via the keyboard.

NOTE: In most system software (including all Data General operating systems), the echo program returns the SAME code it receives from the terminal when an alphanumeric character is entered via the keyboard. However, the code or code sequence returned when display commands and user function codes are received from the terminal often vary with the system software.

Carry out steps a through c below. If the terminal does NOT respond correctly, go to step 6; otherwise, perform the "Screen Parameter Checkout." If you do not know what codes the echo program returns when certain characters or commands are entered via the keyboard, do not enter them until step 7.

- a. If the SAME code is returned for alphanumeric characters, enter each alphanumeric character and see if the terminal displays the appropriate character (see appendix A).
  - b. If the SAME code is returned for display commands, carry out steps 6 through 20 of the off-line checkout given in table 5.2.
  - c. If DIFFERENT codes are returned and you know how the terminal should respond to these codes, enter the command that generates the code and see if the terminal responds correctly. (Chapter 2 contains information on how to generate the ASCII codes and code sequences via the keyboard.)
6. If the terminal does not respond correctly, carry out the corrective action indicated in table 5.4 and repeat the procedure(s) in step 5 that produced the incorrect response. If the response is still incorrect, continue the checkout; otherwise, go to "Screen Parameter Checkout."

Table 5.4 Troubleshooting on-line problems

Terminal's Response	Corrective Action
Screen always blank.	Turn up intensity.
Only cursor displayed - no other response.	Make sure that: (1) communications cable is securely seated in the EIA/CURRENT LOOP receptacle at the rear of the terminal; and, (2) the terminal's baud rate is compatible with the host computer (see figure 3.4).
Solid white block displayed.	Make sure that both the terminal's baud rate and parity are compatible with host computer (see figure 3.4).
None of the above.	Use the terminal tester to determine if the terminal or the rest of the system is faulty (see manual on-line checkout, step 7).

7. Use the DASHER terminal tester to determine whether the terminal or the system is faulty as described below (See "How to Use and Service the DASHER Terminal Tester," DGC No. 015-000087.)
  - a. Disconnect the communications line from the EIA/CURRENT LOOP receptacle at the rear of the terminal and plug the tester's serial tester/terminal cable into that receptacle.
  - b. Set up the terminal tester to display the codes it receives from the terminal. Enter each character or command that produced an incorrect response or was not entered in step 5. Check the code displayed by the tester.
  - c. If any displayed code is incorrect (i.e., not the code for the character or command entered), replace the terminal's circuit board.
  - d. If all the displayed codes are correct:
    - Set up the tester to transmit codes to the terminal.
    - Transmit the codes back to the terminal and check the terminal's response.
    - If the terminal responds incorrectly, replace the circuit board.
    - If it responds correctly, the problem is not with the terminal.

## SCREEN PARAMETER CHECKOUT

This checkout should be the last one performed, since the screen parameters may be affected by replacement of the circuit board or the CRT/yoke assembly.

Check the four screen parameters - width, height, bias, and focus - as described below. Before the screen width and height can be checked accurately, the screen should be filled with characters. This can be done in several ways:

- ⊙ Entering a screen full of characters via the keyboard.
- ⊙ Temporarily shorting test point TP12 on the circuit board to ground (see chapter 9).

**WIDTH** - Fill the screen with characters and measure the length of a full line of characters. The line should measure 8.5 +/- 0.25 inches (21.6 +/- 0.6 centimeters). If it does NOT, carry out the adjustments listed below following the procedures in chapter 9. Be sure to perform the adjustments in the order listed.

1. +5V supply
2. screen width
3. screen height
4. bias
5. focus

**HEIGHT** - Fill the screen with characters and measure the height of a full column of characters. If the column does NOT measure 5.5 +/- 0.25 inches (14.0 +/- 0.6 centimeters), perform the screen height adjustment (see chapter 9).

**BIAS** - Turn the brightness control knob counter-clockwise as far as possible. If the screen is not completely blank, perform the bias adjustment (see chapter 9).

**FOCUS** - Turn the brightness control knob clockwise until the characters appear brightly. If the characters do not appear in focus at the center of the screen, perform the focus adjustment (see chapter 9).

## CHAPTER 6 TROUBLESHOOTING WITH TEST PROGRAMS

The PRINT X program contains various tests for checking the operation of terminals and printers. One subset of these tests is explicitly for testing D100/D200 terminals. Since running PRINT X ties up the whole system, chances are that you will not be able to use it except in special situations, such as when you install an entire system or several D100/D200 terminals at once.

In order to run the program, the system must have the following equipment:

- A NOVA or ECLIPSE computer with at least 16K words of memory
- A magnetic tape drive or disc drive
- A console terminal

In addition, the program presupposes that the controllers for the terminals to be tested are operating properly. However, the program will identify and report controller malfunctions whenever possible.

### USING PRINT X

Table 6.1 describes each of the PRINT X tests explicitly for use with the D100/D200 terminals. Most of these tests send characters or messages to each terminal being tested. These characters and messages should be displayed in the modes (blink, dim, underscore, reverse video) in which they are sent.

Running each of these programs provides a good on-line checkout of the system. This checkout takes approximately 13 minutes at 4800 baud. If you eliminate the cursor test (test #702), it only takes 7 minutes.

Table 6.1 PRINT X tests for DASHER D100/D200 terminals

Test Number	Name	Description
701	Model Number Report Request	Terminals are tested sequentially. A model number report is displayed. (See chapter 2.)
702	Cursor Test	The cursor is sequentially positioned at each location on the screen. At each location the cursor position is read. The cursor's position is moved and its position is read again to make sure it moved to the proper location.
703	Blinking Characters	One page of blinking "B"s is sent to each terminal.
704	Blink Disable Test	Blinking is disabled and a Start Blink command is issued. One page of "N"s is sent to each terminal. The "N"s should not blink.
705	Start/End Blink Test	Start Blink and End Blink commands are issued for each location on a screen.
706	Dimming Characters	One page of dimmed "D"s is sent to each terminal.
707	Start/End Dim Test	Start Dim and End Dim commands are issued for each location on a screen.
710	Underscored Characters	One page of underscored "U"s is sent to each terminal.
711	Start/End Underscore Test	Start Underscore and End Underscore commands are issued for each location on a screen.
712	Reverse Video Test	One page of reverse video "R"s is sent to each terminal.
713	Start/End Reverse Video Test	Start Reverse Video and End Reverse Video commands are issued for each location on a screen.
714	Roll Disable Test	The message "ROLL DISABLED" is sent to each line on a terminal's screen.

Table 6.1 PRINT X tests for DASHER D100/D200 terminals (continued)

Test Number	Name	Description
715	Roll Enable Test	The message "ROLL ENABLED" is sent to each line on a terminal's screen. The message first appears in the upper right hand corner. The beginning of each consecutive line has one less space until the message starts at the beginning of the line.
716	Erase End of Line	Lines starting with "N"s and ending with "E"s are sent to each terminal. Each consecutive line has one less "N" and one more "E". After each line is displayed, the "E"s in that line are erased.
717	Normal Character Set	One page of the character set in normal mode is sent to each terminal. Each consecutive character set is rotated one character.
720	Blinking Character Set	One page of the character set in blink mode is sent to each terminal. Each consecutive character set is rotated one character.
721	Blinking Dimmed Character Set	One page of the character set in blink and dim modes is sent to each terminal. Each consecutive character set is rotated one character.
722	Blinking Reverse Video Character Set	One page of the character set in blink and reverse video modes is sent to each terminal. Each consecutive character set is rotated one character.
723	Blinking Underscored Character Set	One page of the character set in blink and underscore modes is sent to each terminal. Each consecutive character set is rotated one character.
724	Blinking Dimmed Underscored Character Set	One page of the character set in blink, dim, and underscore modes is sent to each terminal. Each consecutive character set is rotated one character.
725	Blinking Reverse Video Underscored Character Set	One page of the character set in blink, reverse video, and underscore modes is sent to each terminal. Each consecutive character set is rotated one character.

Table 6.1 PRINT X tests for DASHER D100/D200 terminals (continued)

Test Number	Name	Description
726	Dimmed Character Set	One page of the character set in dim mode is sent to each terminal. Each consecutive character set is rotated one character.
727	Dimmed Underscored Character Set	One page of the character set in dim and underscore modes is sent to each terminal. Each consecutive character set is rotated one character.
730	Reverse Video Character Set	One page of the character set in reverse video mode is sent to each terminal. Each consecutive character set is rotated one character.
731	Reverse Video Underscored Character Set	One page of the character set in reverse video and underscore modes is sent to each terminal. Each consecutive character set is rotated one character.
732	Underscored Character Set	One page of the character set in underscore mode is sent to each terminal. Each consecutive character set is rotated one character.
733	Printer Option	One page of "P"s is sent to each terminal. If the printer option is present, the "P"s should be printed.
734	Printer Option Print Form	An alternating pattern of normal "P"s and dimmed "D"s is sent to each terminal. If the printer option is present, the "P"s should be printed.
735	Test Bell	A bell command and the message "BELL" is sent to each terminal.



To run PRINT X, do as follows:

1. Put the terminal in ALPHA LOCK mode.
2. Load DTOS. (For information on loading procedures, see either the DTOS summary manual, No. 015-000082, or the field service manual for the NOVA or ECLIPSE computer used in the system.) If DTOS will not load, you cannot use PRINT X to check the terminal's on-line operation; instead, perform the manual on-line checkout in chapter 5.
3. Enter the following command on the system console to load PRINT X:

```
* LOAD PRINT X
```

As soon as the program is loaded, the following text appears on the system console:

```
LOAD: PRINT X REV. 01
```

```
PRINT X - PRINTER/DISPLAY EXERCISER
```

```
ENTER ? FOR HELP.
```

The program then asks for the type of terminal and the type and device code of the terminal's controller. These questions together with sample operator input are given in table 6.2. Note that each response must be terminated by a CARRIAGE RETURN (CR). The program goes on to run the selected tests.

4. To carry out a complete on-line checkout enter a CR in response to TESTS? This will run all the tests listed in table 6.1. To run all but the cursor test, enter: "701 703 THRU 735". To check out a particular feature, simply enter the numbers of the applicable tests. Several control commands are available for controlling the tests. These are described in table 6.3.
5. If the terminal does not respond as described in table 6.1, replace the printed circuit board.

Table 6.2 PRINT X program output

Program Output	Sample Operator Input	Notes
<p>TESTING?</p> <p>(1) KEYBOARD AND TROUBLESHOOTING            (2) LP2/TP2 DASHER PRINTER            (3) LINEPRINTER            (4) RESERVED            (5) DASHER PRINTER            (6) 6052 OR 6053 DASHES LOW COST DISPLAY            (7) 6106 THRU 6109 DASHES D100/D200 DISPLAY            (10) RESERVED            (11) RESERVED</p>	7 CR	1
<p>CONTROLLER?</p> <p>(1) 4010 20 MA OR 4023 EIA ON 4007 (SINGLE LINE ASYNC)            4077 20 MA OR 4078 EIA ON 4075 (CASS TTY SINGLE LINE)            (2) 4207 MICRONOVA 1 LINE ASYNC            (3) RESERVED            (4) RESERVED            (5) 4255 8 LINE OR 4256 4 LINE ALM-8 MUX            4257 16 LINE OR 4258 8 LINE ALM-16 MUX            (6) 4241 ULM-5 ASYNC INTFC            (7) CS40 OR CS60 SBS 4 LINE MUX            (10) CS40 OR CS60 SBS PARALLEL INTERFACE            (11) 4034 PARALLEL INTERFACE            (12) OKIDATA            (13) 4215 DATA CHANNEL (COMM I/O)            (14) 4225 MICRONOVA 16 LINE MUX            (15) RESERVED</p>	1 CR	
DEVICE CODE?	CR	2
TESTS? (^T FOR LIST)	CR	3

Notes:

1. "7 CR" must be entered for D100/D200 terminals.
2. Input "CR" for default device code 10.
3. The program messages use the symbol "^" to refer to the control (CTRL) key. Entering a CR in response to TEST? will run all the D100/D200 tests listed in table 6.1. To select a particular test simply enter the test number.

\* For information on loading procedures, see either the DTOS summary manual, No. 015-000082, or the field service manual for the NOVA or ECLIPSE computer used in the system.

Table 6.3 Test control commands

Command	Function
CRTL-C	Enables selection of another test
CRTL-Q	Starts program output
CRTL-R	Restarts PRINT X
CRTL-S	Stops program output
CTRL-T	Lists tests
CTRL-U	Lists switch register (SWREG) meanings
CTRL-V	Enables change of output mode.
CTRL-W	Selects next test
CTRL-Y	Lists mode summary
ESC	Returns to DTOS
?	Lists complete table of test control commands
M	Lists switch register (SWREG) settings



Data General Corporation (DGC) has prepared this manual for use by DGC personnel and customers as a guide to the proper installation, operation, and maintenance of DGC equipment and software. The drawings and specifications contained herein are the property of DGC and shall neither be reproduced in whole or in part without DGC's prior written approval nor be implied to grant any license to make, use, or sell equipment manufactured in accordance herewith.

## PART 3

### FUNCTIONAL OVERVIEW



## CHAPTER 7 OPERATIONAL OVERVIEW

D100/D200 terminals consist of two separate units - a display and a keyboard - that are connected by an external cable. The display houses a cathode ray tube (CRT) and yoke assembly and one printed circuit board. This modular design facilitates maintenance because malfunctions can be isolated to one of three main components: the circuit board, the CRT/yoke assembly, or the keyboard.

### PRINTED CIRCUIT BOARD

The circuit board contains four major units: the control logic, the display logic, the interface logic, and the power supply. These units, except for the power supply, are connected by a bi-directional bus as shown in Figure 7.1.

#### Control Logic

The control logic governs the terminal's response to ASCII codes from the computer and commands from the keyboard. Its main components are a microprocessor and a read-only-memory (the program ROM).

The microprocessor synchronizes the operations of the other units and coordinates the transfer of information between them. It also stores the current attributes that determine how characters will be displayed (e.g., blinking, underscored, etc.).

The program ROM stores the instructions (firmware) that the microprocessor executes to control the other units.

Data General Corporation (DGC) has prepared this manual for use by DGC personnel and customers as a guide to the proper installation, operation, and maintenance of DGC equipment and software. The drawings and specifications contained herein are the property of DGC and shall neither be reproduced in whole or in part without DGC's prior written approval nor be implied to grant any license to make, use, or sell equipment manufactured in accordance herewith.

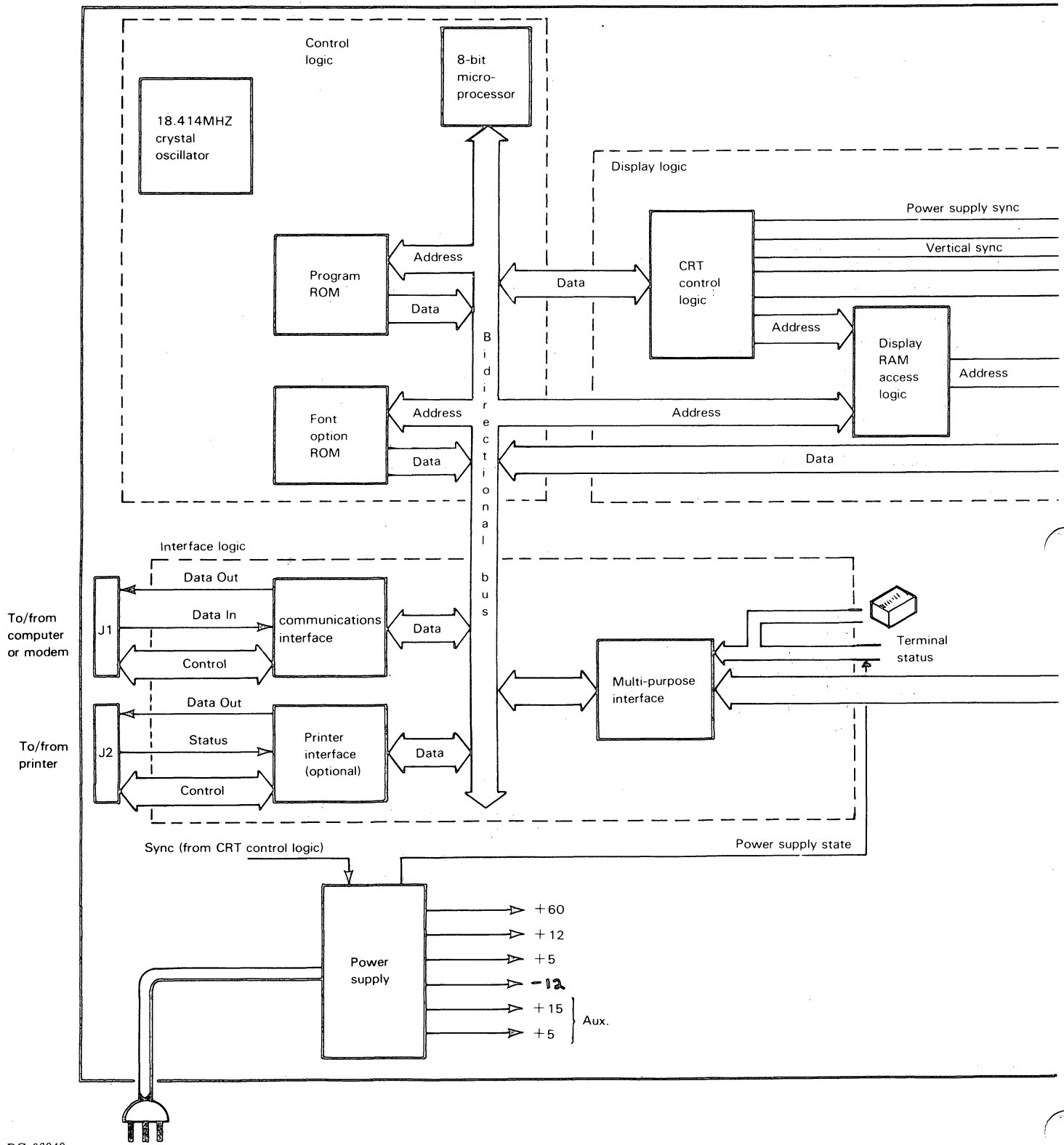

DG-06840

Figure 7.1 Terminal block diagram



Data General Corporation (DGC) has prepared this manual for use by DGC personnel and customers as a guide to the proper installation, operation, and maintenance of DGC equipment and software. The drawings and specifications contained herein are the property of DGC and shall neither be reproduced in whole or in part without DGC's prior written approval nor be implied to grant any license to make, use, or sell equipment manufactured in accordance herewith.

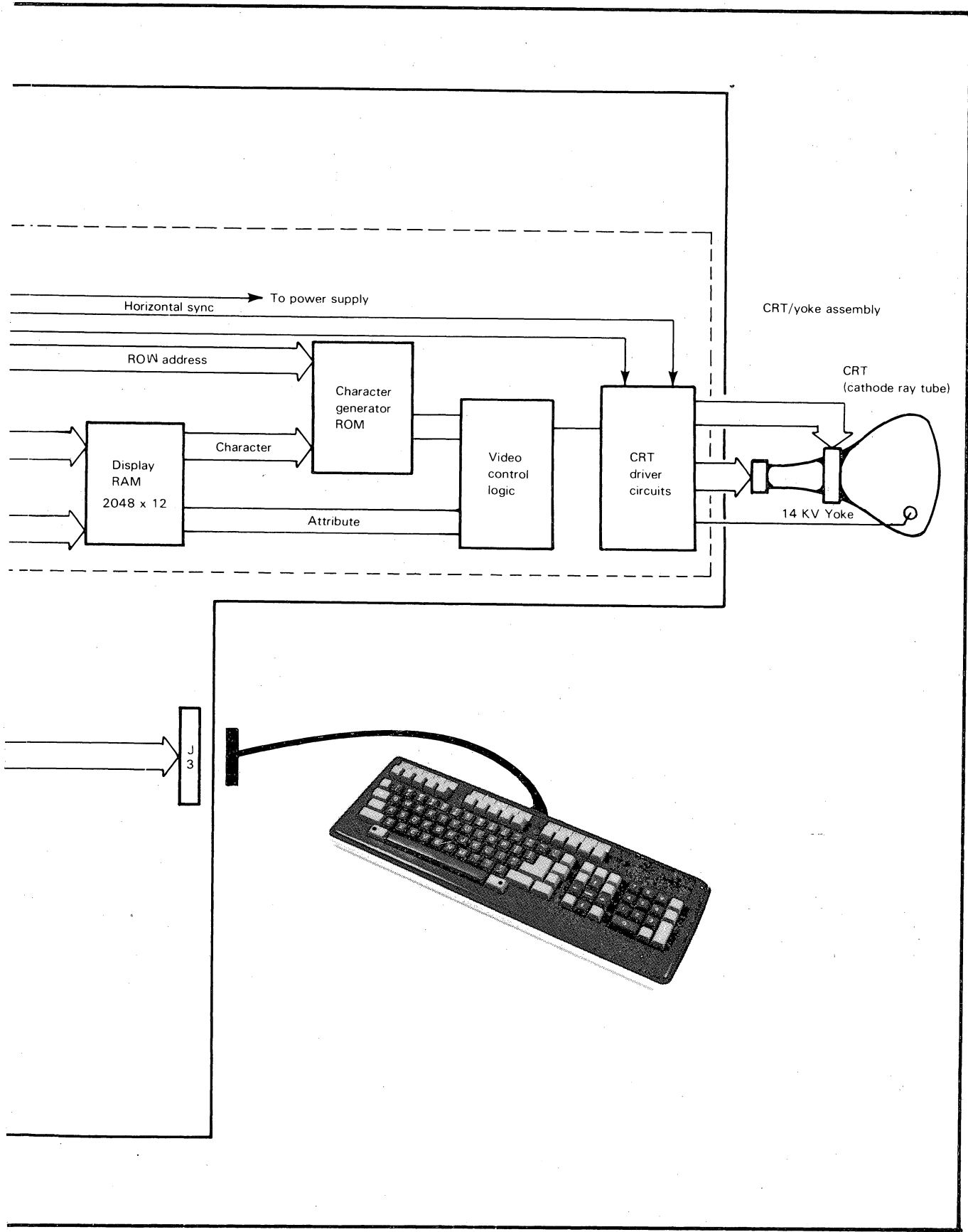

## Display Logic

The display logic controls cursor positioning, the displaying of characters, and screen rolling. Its main components are a display RAM, the CRT control logic, and a character generator ROM.

The display RAM stores the ASCII codes for the characters to be displayed on the screen as well as each character's attributes.

The CRT control logic controls display operations. It is programmed by the microprocessor to perform the following functions:

- ⊙ Initiates screen refreshing by continually providing the CRT driver circuits with synchronizing signals and the current contents of the display RAM.
- ⊙ Maintains the cursor address and controls the positioning of the cursor accordingly.

The character generator ROM stores the bit patterns that determine how each displayable character appears on the screen. Different character generator ROMs are used for the different character fonts.

## Interface Logic

The interface logic contains three interfaces. An asynchronous serial interface allows communication in full-duplex mode between the microprocessor and a computer via a 20mA current loop or an EIA RS-232-C communications line. When the split baud/printer option is present, an additional asynchronous serial interface (printer interface) allows communication between the microprocessor and a local printer via an EIA RS-232-C communications line. Both interfaces use a universal asynchronous receiver/transmitter (UAR/T).

The line characteristics (e.g. baud rate, parity) for these two interfaces are selected by on-board switches. When the terminal is powered-up or switched on-line, the microprocessor senses the setting of these switches and programs the interface(s) to function accordingly.

A multi-purpose interface connects the control logic (via the bidirectional bus) to the keyboard (via the external cable). This interface also passes the values of switch settings to the microprocessor.

## Power Supply

The power supply provides the d.c. supply voltages necessary to drive the various circuits within the terminal. The primary power input is either 85-132 V a.c. or 187-264 V a.c., 47-63 Hz, as selected by hardwired jumpers on the board.

The power supply uses a switching regulator to provide the output voltages. The incoming a.c. voltage is converted to a d.c. voltage and fed through a high frequency oscillator and into a transformer. The outputs of the transformer are rectified and filtered to provide the various output voltages. Constant power output is maintained by varying the duty cycle of the oscillator (pulse width modulation). Protection circuits prevent damage in the event of an over-current or over-voltage condition.

The switching of the supply is synchronized to occur when the display screen is retraced, i.e., when the electron beam in the CRT is shut off and the CRT is preparing for the next screen scan. This prevents switching pulses from appearing on the screen.

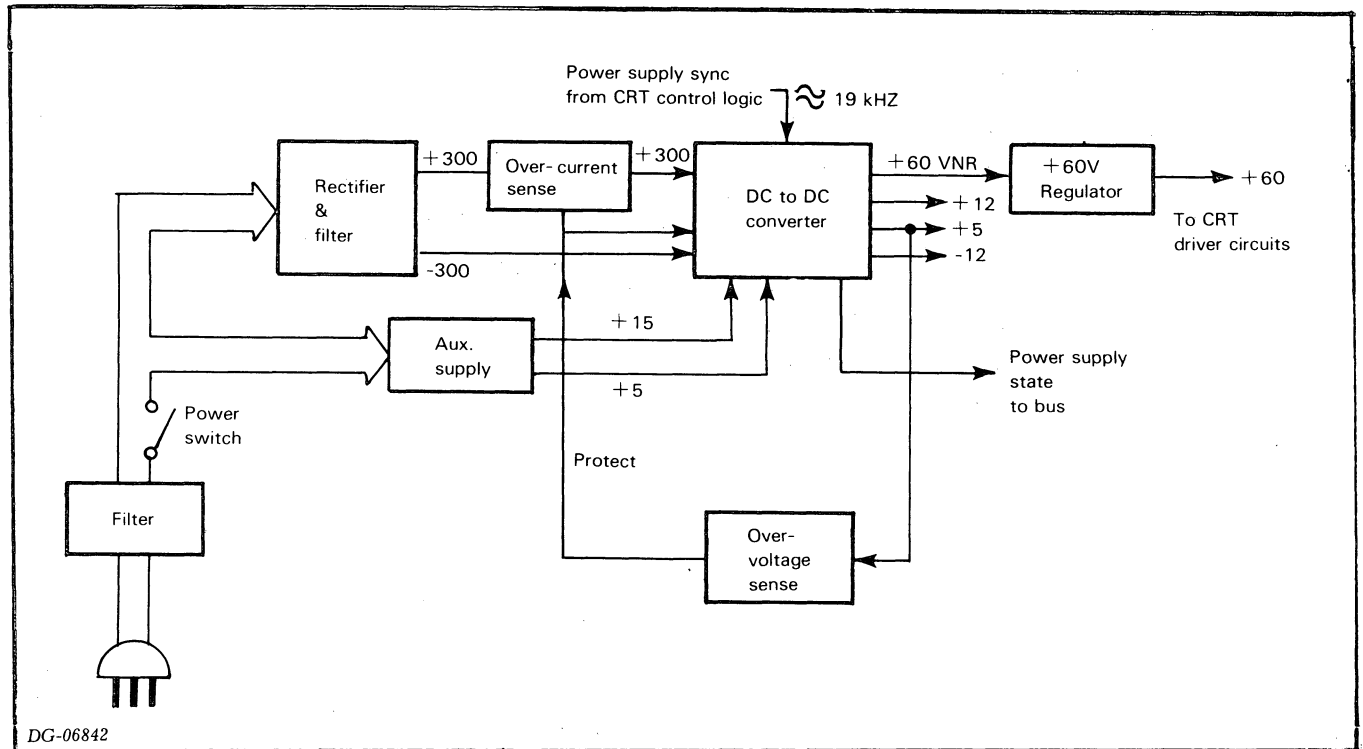

Figure 7.2 Power supply block diagram

## CRT/Yoke Assembly

The CRT (cathode ray tube) is a vacuum tube that projects a beam of electrons towards a fluorescent screen. When this beam hits the screen it forms a luminous dot. Signals generated by the CRT driver circuits control the presence and intensity of this dot.

The yoke assembly is an electromagnetic deflection device that moves the electron beam in response to drive signals generated by the CRT control logic. These signals cause the beam to trace out a system of parallel horizontal scans on the screen. Eighty column positions are defined within each horizontal scan. Each column consists of seven dots which form part of a matrix. Eleven consecutive scans form a line of eighty 7 by 11 dot matrices. A character is displayed by controlling the intensity of the dots within a dot matrix as shown in Figure 7.3. Appendix B gives the 7 by 11 dot pattern for each character.

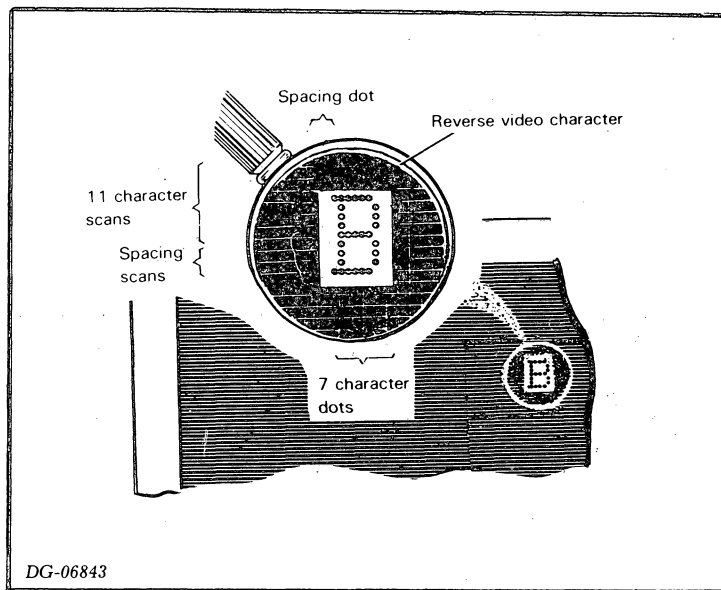

Figure 7.3, Dot matrix on display screen

## KEYBOARD

The keyboard consists of keypads mounted on a printed circuit board and three (D100) or two (D200) LED indicator lights. The printed circuit board contains sense circuitry that allows the microprocessor to determine which keys are pressed when it scans the keyboard. Figure 7.4 shows this circuitry.

When a key is depressed, it moves an insulated foam-backed foil pad towards two contacts on the printed circuit board, thus increasing the capacitance between the foil and the contacts. When the microprocessor scans this key, it detects the increase in capacitance and identifies the location of the key.

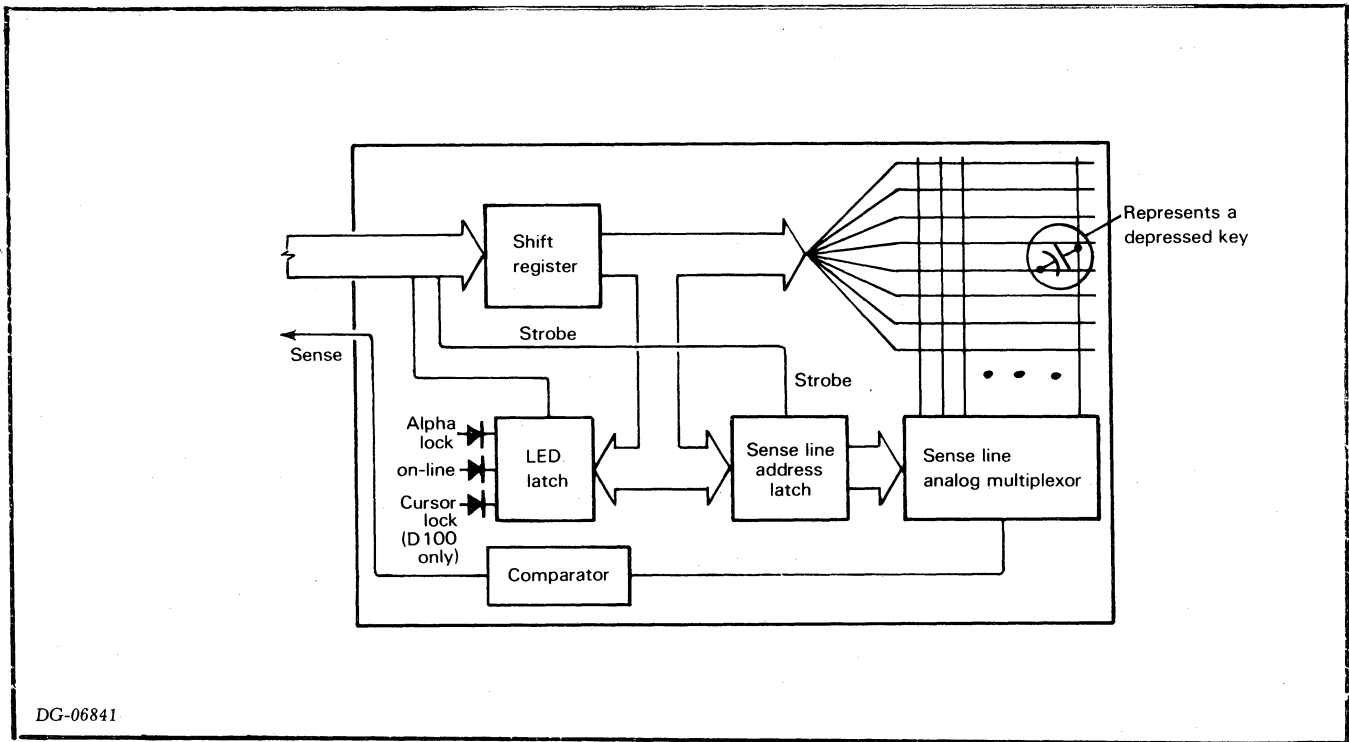

Figure 7.4 Keyboard block diagram

## OPERATION

The terminal operates in two different modes: on-line and off-line. On-line the terminal functions as two different I/O devices - a keyboard input device and a display output device. Communication between these two devices must be provided by the computer's software. This means that all displayable information entered at the keyboard must be "echoed" to the display by the executing program. Off-line the terminal functions as one device. Figure 7.5 shows how the terminal functions in both of these modes.

### Powering Up

When the terminal is powered up, the microprocessor executes a series of diagnostic programs that test the operation of the control logic and the presence of the keyboard. As soon as it completes these tests, the microprocessor initializes the character attributes to a default state where screen rolling is enabled and no characters will be blinking, dimmed, underscored, or in reverse video format until these attributes are specified by display commands.

Besides initializing the character attributes, the microprocessor turns off the alpha lock to place the terminal in lower case mode. In a D100 terminal, it also places the terminal in cursor lock mode to enable the cursor pad.

Next, the microprocessor places the terminal on-line if the computer communications connector is installed; otherwise, the terminal stays off-line. In on-line mode the microprocessor constantly scans the keyboard for pressed keys and checks the communications interface for ASCII codes received via the communications line. In off-line mode, it only scans the keyboard.

### Scanning Keyboard

The microprocessor scans the keyboard by addressing consecutive keys. If the addressed key is pressed, the sense circuitry on the keyboard sends a pulse to the microprocessor. If the same key (or combination of keys) is pressed for two consecutive scans of the keyboard, the microprocessor generates the ASCII code for the key (or combination) from its address. It then transfers this code to the communications interface for transmission (on line) or processes the code internally (off line) as if it was received from the communications interface.

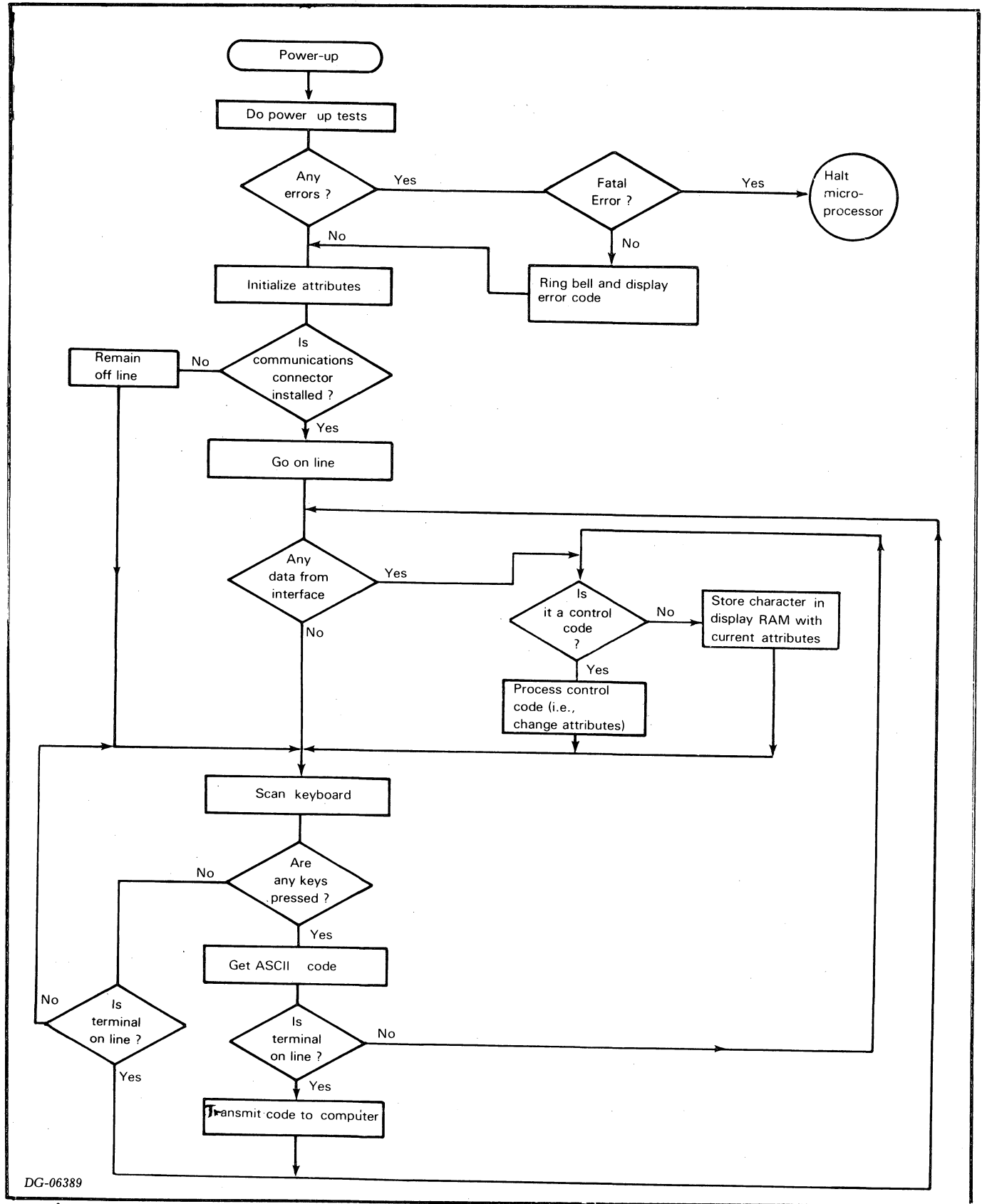

DG-06389

Figure 7.5 Functional flow

## Communications Interface

The microprocessor sends ASCII codes to the communications interface (on line) where they are converted into serial format and transferred to the communications line.

When the terminal receives an ASCII code via the communications line, the communication interface assembles the data into an 8-bit buffer. As soon as the code is assembled, the interface notifies the microprocessor to retrieve the code.

## Processing Codes

When the microprocessor receives a code from the communications interface (on line) or senses a pressed key (off line), it first determines if the code is a control character or a displayable character. If it is a control character (000 to 037), the microprocessor performs the defined function. For example, the Start Dim command causes the microprocessor to change the current attribute settings so that subsequent displayable characters are dimmed. If a printing character (040 to 176) is received, the microprocessor stores the character's ASCII code, along with a copy of the current attributes, in RAM.

## Displaying Characters

The CRT control logic continually addresses sequential locations in display RAM, accessing character codes and their attributes. In this way, the logic updates the screen as the microprocessor changes the contents of the display RAM.

The character codes, read from display RAM, address locations in the character generator ROM that contain bit patterns used to form each character. These bit patterns, along with the attribute information, enter the CRT driver circuits where they are converted into the voltage levels required by the CRT/yoke assembly. At the same time, the CRT control logic generates the cursor and provides the horizontal and vertical synchronizing signals to position the characters on the screen.



## FRU INTERCONNECTION

The FRUs are connected to each other by several wires as shown in figure 7.6.

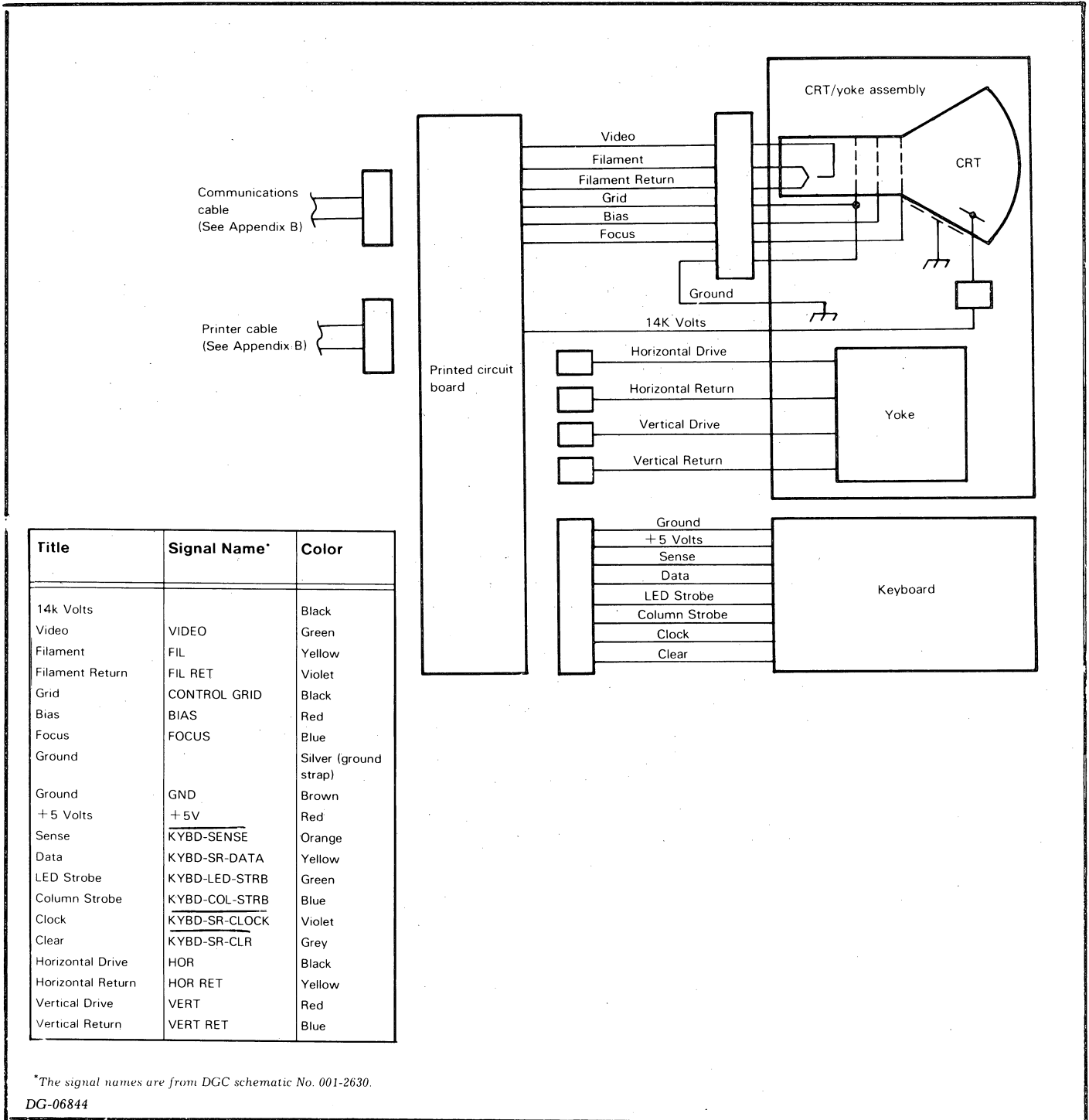

Figure 7.6 Interconnection diagram



Data General Corporation (DGC) has prepared this manual for use by DGC personnel and customers as a guide to the proper installation, operation, and maintenance of DGC equipment and software. The drawings and specifications contained herein are the property of DGC and shall neither be reproduced in whole or in part without DGC's prior written approval nor be implied to grant any license to make, use, or sell equipment manufactured in accordance herewith.

## PART 4

### REPLACEMENT AND ADJUSTMENT PROCEDURES



## CHAPTER 8 INSTALLING AND REMOVING FRUS

This chapter contains the procedures for accessing, removing, and installing field replaceable units (FRUs). When performing these procedures, observe the following general precautions:

- Be careful when working with the main printed circuit board and the CRT/yoke assembly. These units carry dangerously high voltages even when the terminal is turned off.
- Remove and replace only those components described in the procedures.
- Remove cables by pulling on the connector rather than the cable, thus preventing cable damage.

The procedures are presented in the order listed below:

1. Opening and Closing the Display Case
2. Keyboard Replacement
3. Printed Circuit Board and CRT/Yoke Assembly Replacements

## OPENING AND CLOSING THE DISPLAY CASE

### TO OPEN THE CASE:

1. Turn off the terminal and unplug the power cord. Pull off the power/brightness knob. Push the switch shaft back in with your finger.
2. Tilt the display unit backward and locate the two screws underneath the front of the case. Unscrew these screws until the screw heads are flush with the case (see figure 8.1).
3. Pull the top of the case up and slightly forward to clear the power/brightness switch shaft. Open the case until the two support rods on either side of the display latch in place.

### TO CLOSE THE CASE:

1. Turn off the power and unplug the power cord.
2. Make sure all the wires between the printed circuit board and the CRT/yoke assembly are connected.
3. Holding the top of the case, unlatch the support rods one at a time by pushing outward on them. Carefully lower the top of the case. Make sure no wires get caught between the case edges.
4. Carefully tighten the two screws underneath the front of the case until they are snug (see figure 8.1). Over-tightening the screws may damage the screw housing.
5. Reinstall the power/brightness knob by gently pushing the knob onto the shaft.

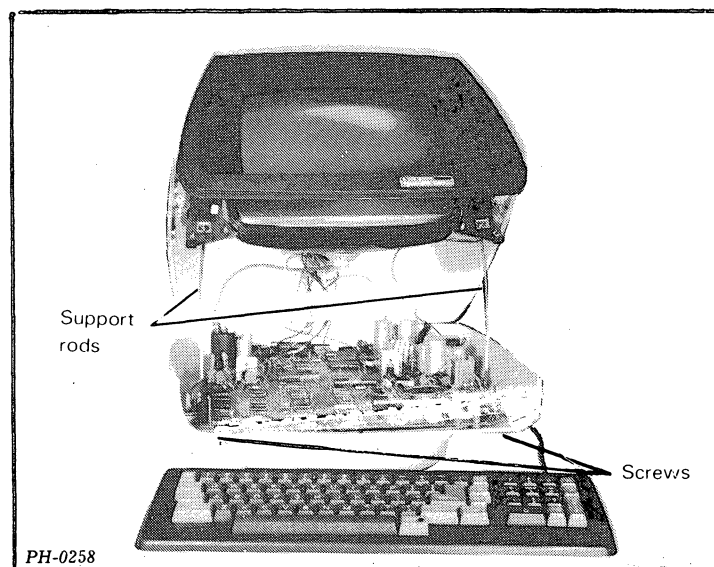

Figure 8.1 Opening and closing the display case

## AMERICAN KEYBOARD REPLACEMENT

1. Turn off the power.
2. Remove the keyboard cable from the keyboard receptacle at the rear of the display by pulling directly outward on the connector (see figure 8.2). Do not pull on the cable.
3. Plug the cable attached to the new keyboard into the display's keyboard receptacle. Notice that the connector is keyed to facilitate proper positioning.
4. Turn on the power and make sure the new keyboard works.

## EXPORT KEYBOARD REPLACEMENT

1. Perform steps 1 through 4 above.
2. Replace and reposition the appropriate keycaps as shown in figures 8.4 through 8.10. Using the applicable figure, locate each keycap that must be changed on the new keyboard, and replace or reposition the keycaps as follows:
  - Holding the keycap removal tool (DGC Part No. 002-11025) straight up with the tabbed end facing the front of the keyboard, push it down around the keycap (see figure 8.3).
  - Gently work the two tabs under the keycap.
  - Pull straight up to remove the keycap. Make sure the spring underneath the keycap does not pop off and get lost.
  - Push on the new keycap making sure the spring is under it.

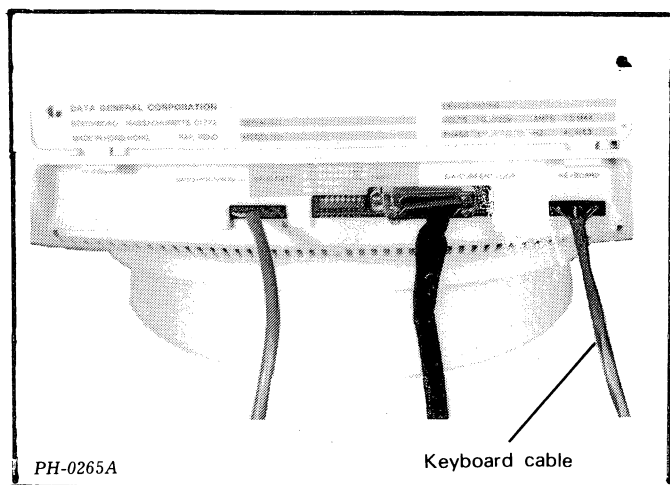

Figure 8.2 Keyboard cable

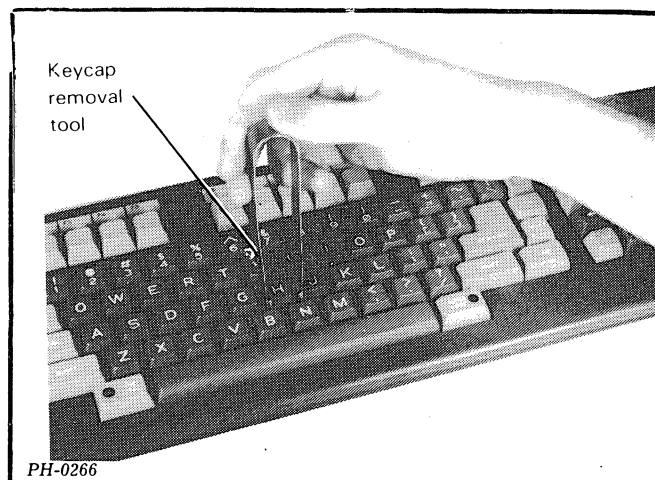

Figure 8.3 Removing a keycap

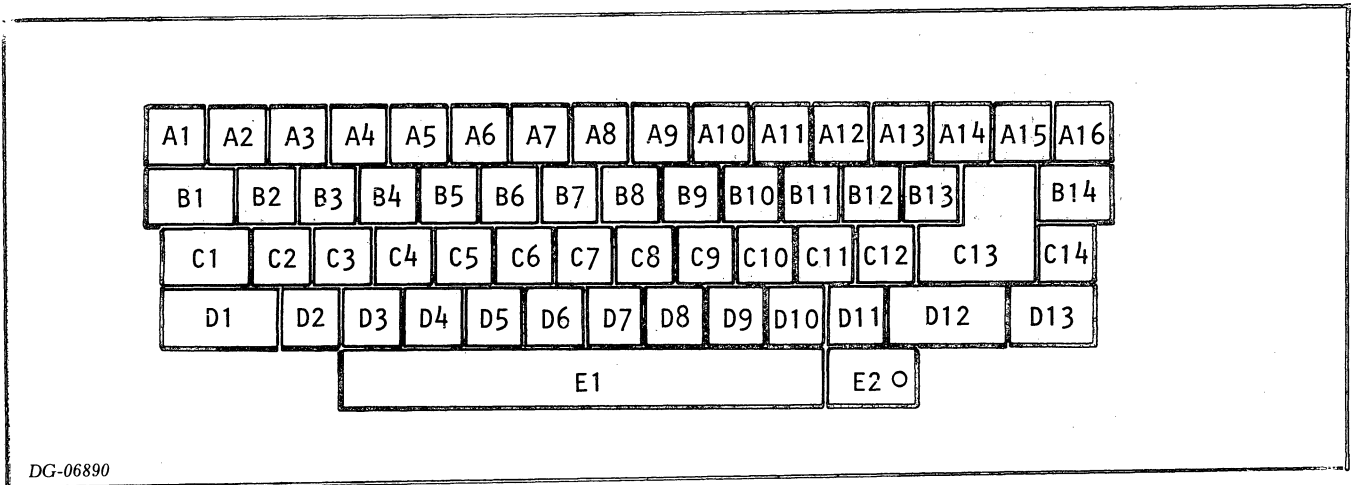

Figure 8.4 Keycap locations

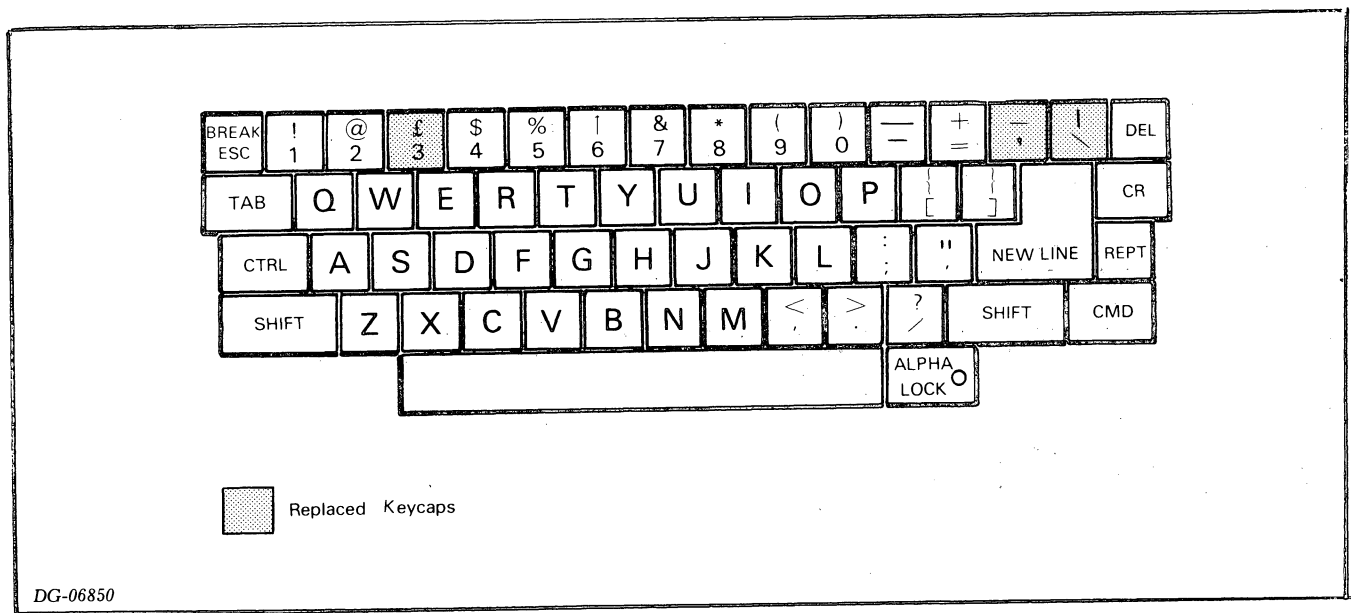

Figure 8.5 british keycaps



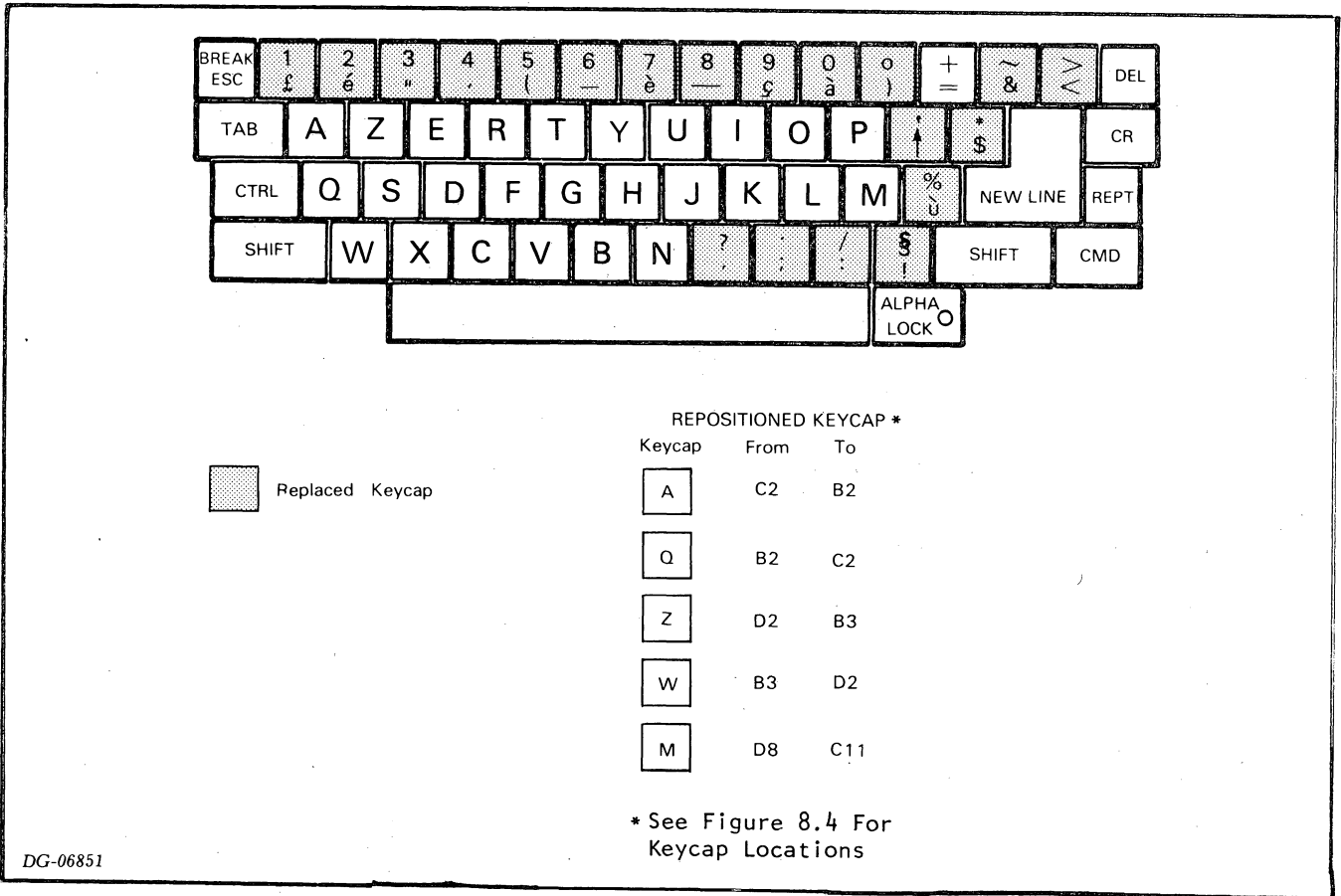

Figure 8.6 French keycaps

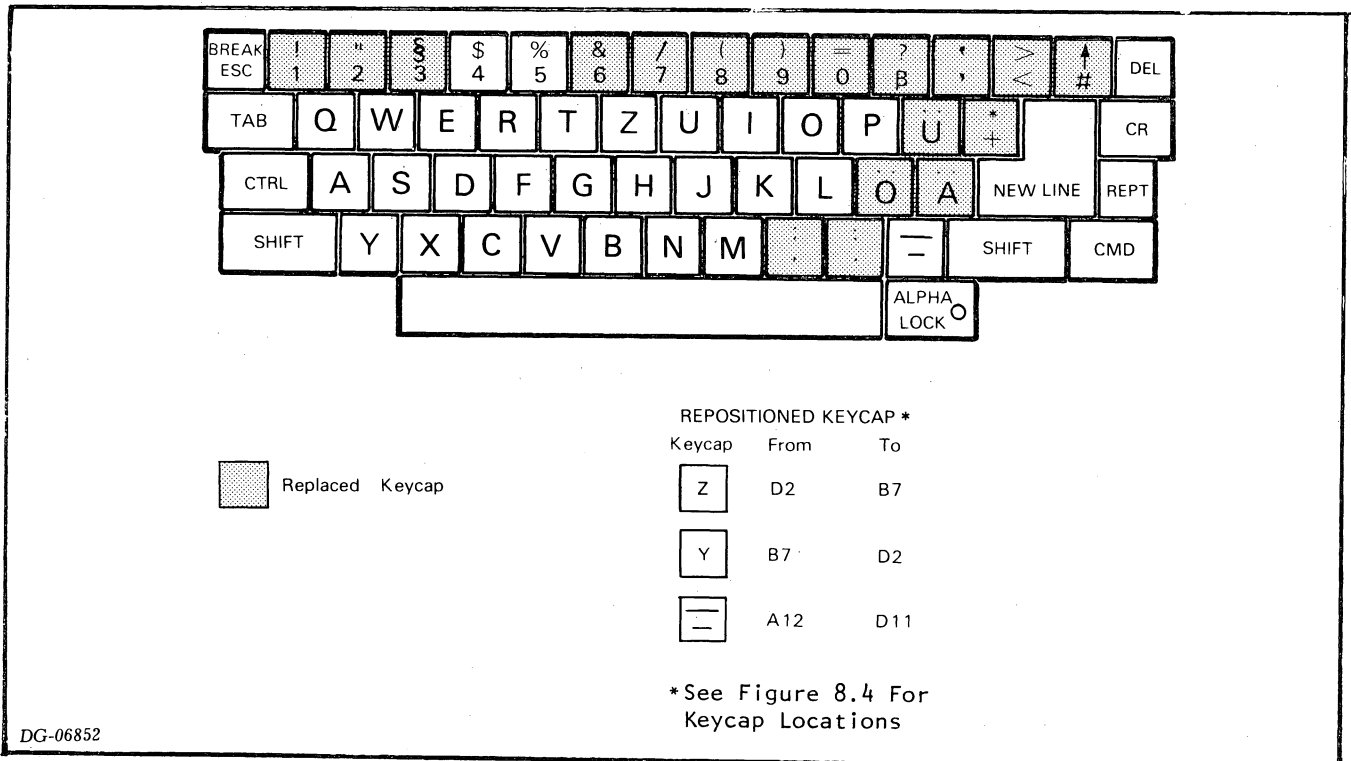

Figure 8.7 German keycaps

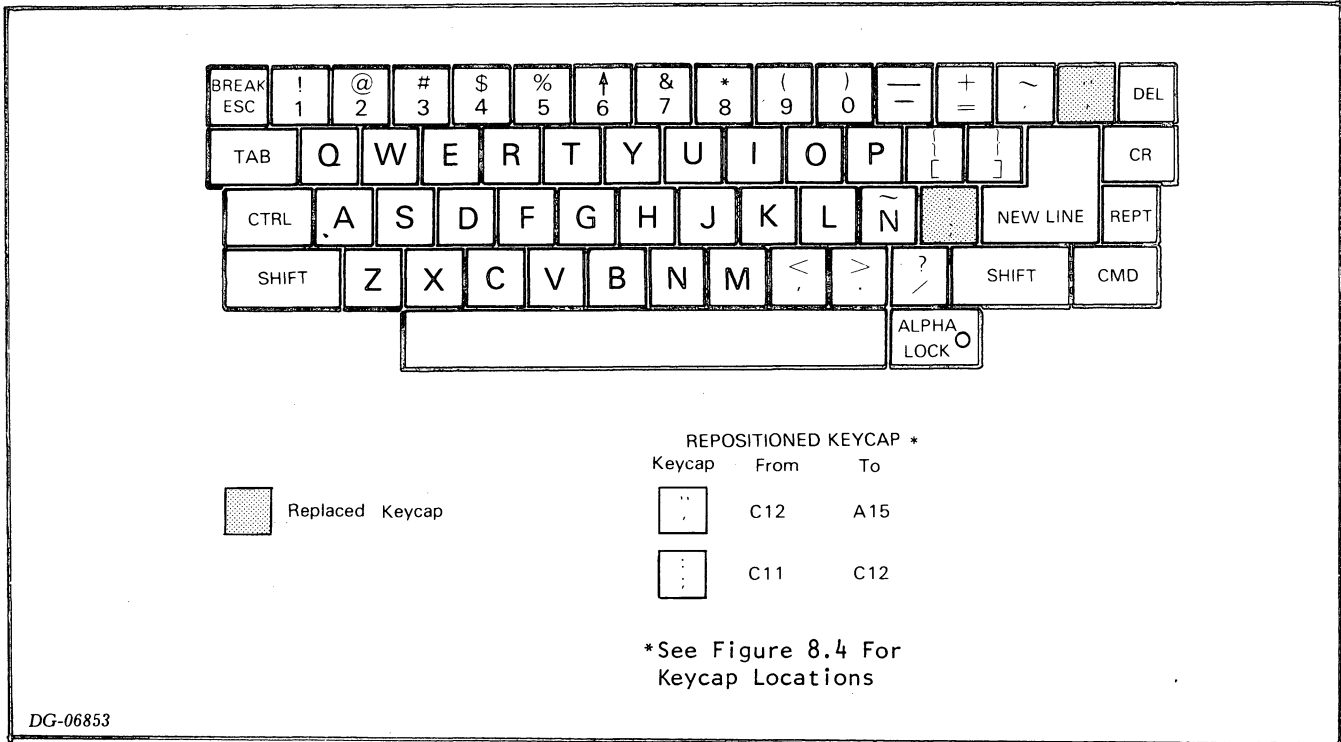

Figure 8.8 Spanish keycaps

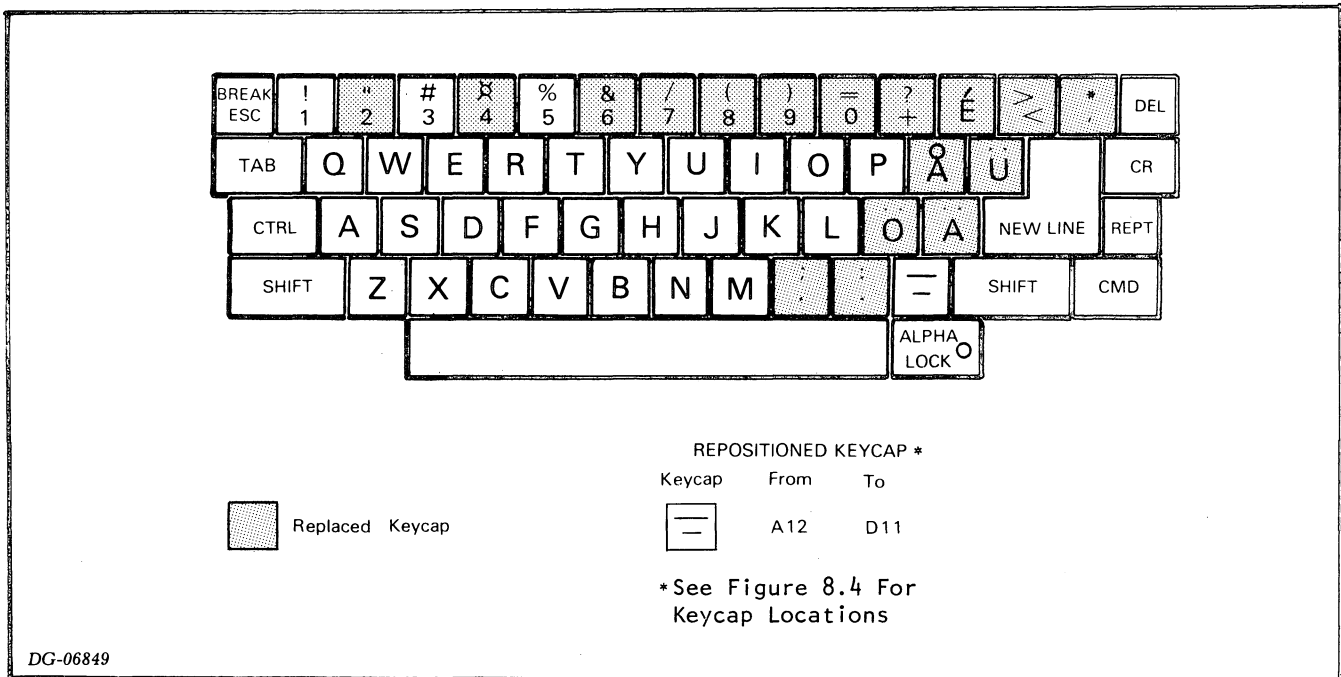

Figure 8.9 Swedish/Finnish keycaps

Data General Corporation (DGC) has prepared this manual for use by DGC personnel and customers as a guide to the proper installation, operation, and maintenance of DGC equipment and software. The drawings and specifications contained herein are the property of DGC and shall neither be reproduced in whole or in part without DGC's prior written approval nor be implied to grant any license to make, use, or sell equipment manufactured in accordance herewith.

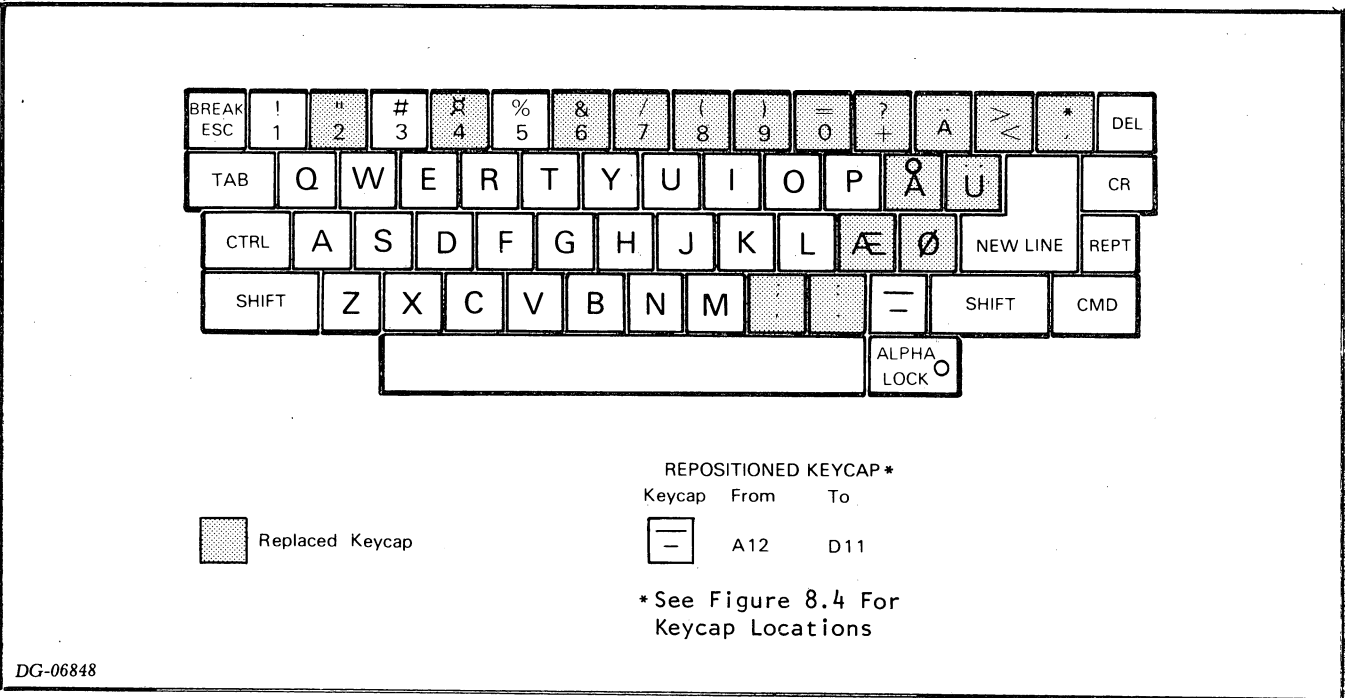

Figure 8.10 Danish/Norwegian keycaps

## PRINTED CIRCUIT BOARD AND CRT/YOKE ASSEMBLY REPLACEMENTS

**WARNING:** Never touch the CRT high voltage anode or the connecting wire without first discharging the CRT since high voltage is present even with the power off (see figure 8.12).

Before removing either the printed circuit board or CRT/yoke assembly, the cables between these two units must be disconnected. Similarly, after installing a new printed circuit board or CRT/yoke assembly, these cables must be reconnected. The procedures for replacing these FRUs are divided into four parts:

1. Disconnecting the board and the CRT/yoke assembly
2. Replacing the board
3. Replacing the CRT/yoke assembly
4. Bleeding the CRT vacuum
5. Connecting the board and the CRT/yoke assembly

To replace the printed circuit board, do steps 1, 2, and 5. To replace the CRT/yoke assembly, do steps 1, 3, 4, and 5.

### DISCONNECTING THE BOARD AND THE CRT/YOKE ASSEMBLY

1. Turn off the power and unplug the power cord.
2. Unplug the following cables from the rear of the display (see figure 8.11):

Keyboard cable  
Communications device cable  
Printer cable (if present)

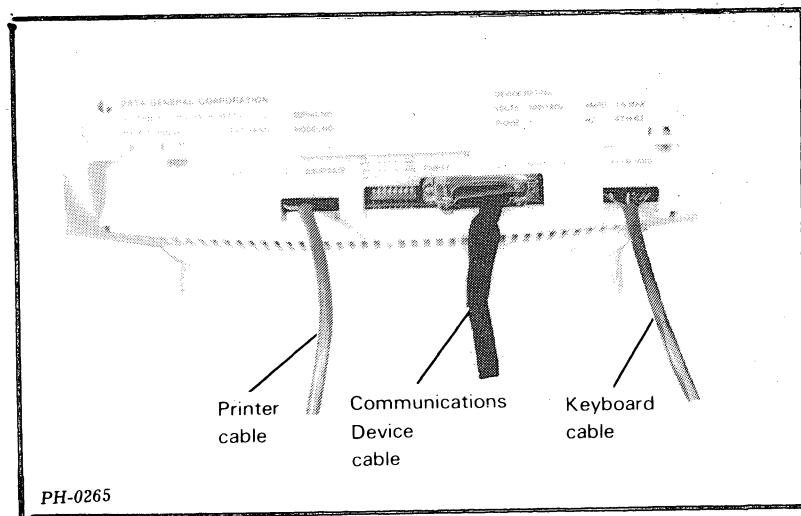

Figure 8.11 External cables

3. Wait a full 5 minutes before continuing (to allow the capacitors to discharge).
4. Open the case until the support rods latch, using the procedure on page 8-2.
5. DISCHARGE THE HIGH VOLTAGE IN THE CRT as follows (see figure 8.12):
  - Fasten one end of a clip lead to an insulated flat-blade screwdriver.
  - Clip the other end of the lead to the CRT support bracket.
  - Carefully push the screwdriver blade under the rubber anode cap. The blade must touch the wires under the cap to short the CRT. You will hear a loud snap when this happens.
  - Repeat the discharge procedure several times until no snap is heard.
6. Unplug the wire from the CRT anode by squeezing the cap between your thumb and index finger and gently pulling it from side to side (see figure 8.13).

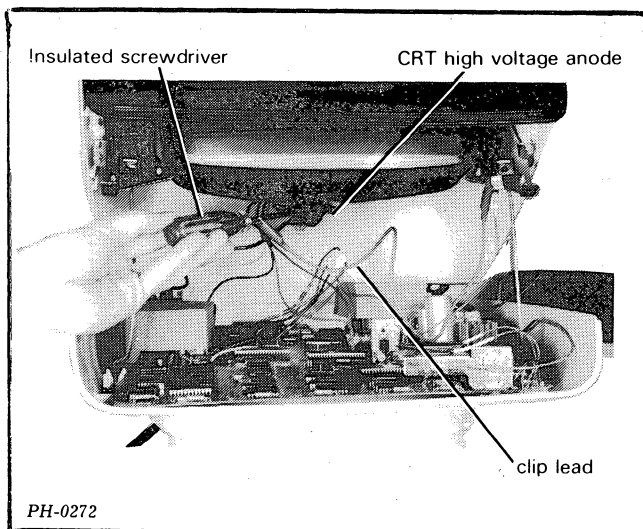

Figure 8.12 Discharging the CRT

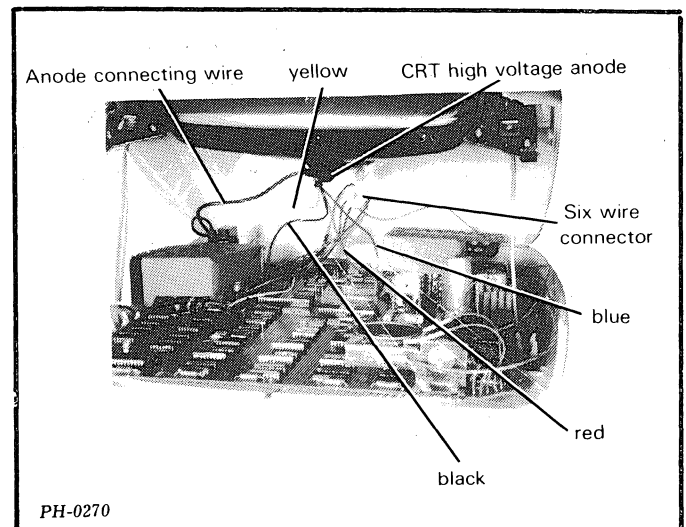

Figure 8.13 CRT/yoke wires

7. Remove the two ground wires from the CRT support bracket (see figure 8.14). You may have to use a flat blade screwdriver to pry off the lead containing the push-on clip.
8. Unplug the six-wire connector from the rear of the CRT neck and the four yoke wires from the main board (see figure 8.13).
9. Holding the top of the case, unlatch the support rods by pushing outward on them. Gently pull the top open to a 90 degree angle. Be careful not to break the hinges at the rear of the case. Lift the top out of the hinges and place it upside-down on a sturdy work surface. Make sure that the top will not roll off the work surface. If it does, the CRT may break and implode.

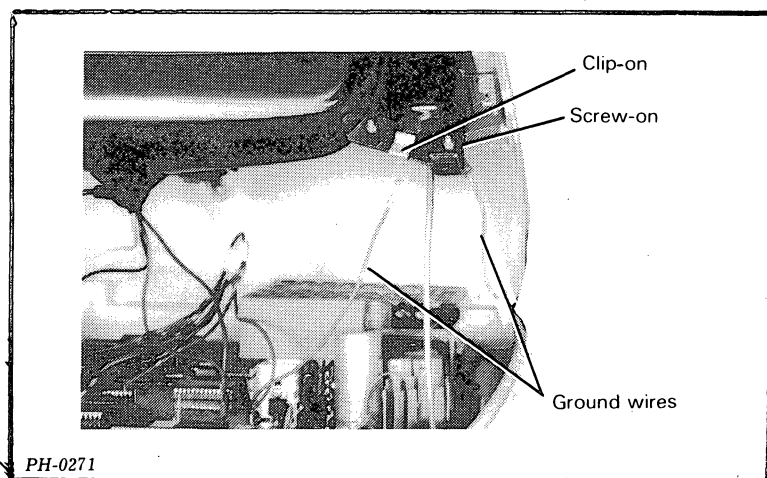

Figure 8.14 Ground wires

## REPLACING THE PRINTED CIRCUIT BOARD

1. Remove the two cardboard covers at the rear of the board by gently pulling up on each cover (see figure 8.15).
2. Remove the 4 hex screws that secure the circuit board to the bottom of the case (see figure 8.15).
3. Grasp the two front corners of the board and gently pull the board forward to clear the rear plastic tabs. With one hand on the left front corner of the board and the other hand on the power cable where it meets the board, gently pull the board out from the rear to avoid interference from the support rods.
4. On an export circuit board, remove both the character generator ROM and the font option ROM from the old board (see figure 8.16). Place these ROMs in the corresponding sockets on the new circuit board. Make sure that the ROMs are properly oriented and that no pins are accidentally bent under the ROM.

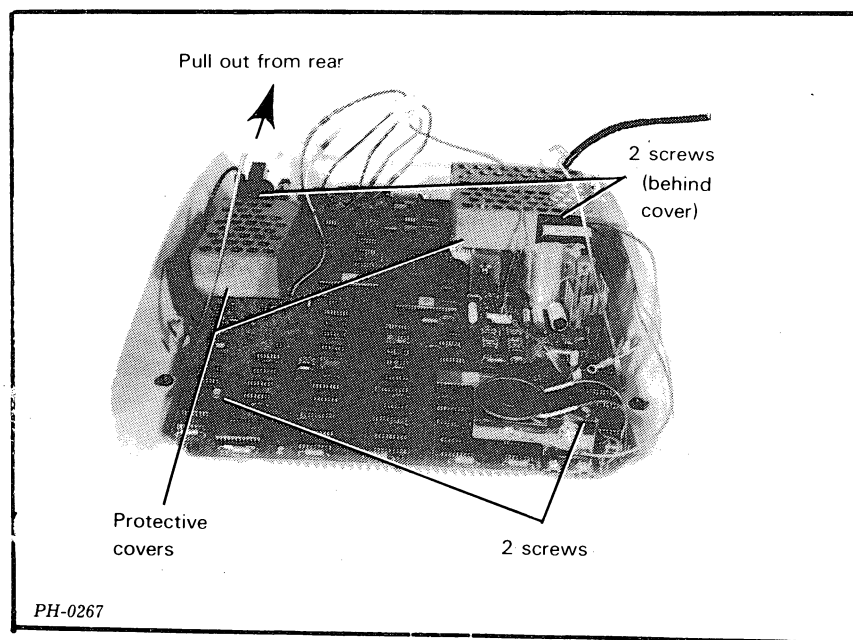

Figure 8.15 Removing the printed circuit board

Data General Corporation (DGC) has prepared this manual for use by DGC personnel and customers as a guide to the proper installation, operation, and maintenance of DGC equipment and software. The drawings and specifications contained herein are the property of DGC and shall neither be reproduced in whole or in part without DGC's prior written approval nor be implied to grant any license to make, use, or sell equipment manufactured in accordance herewith.

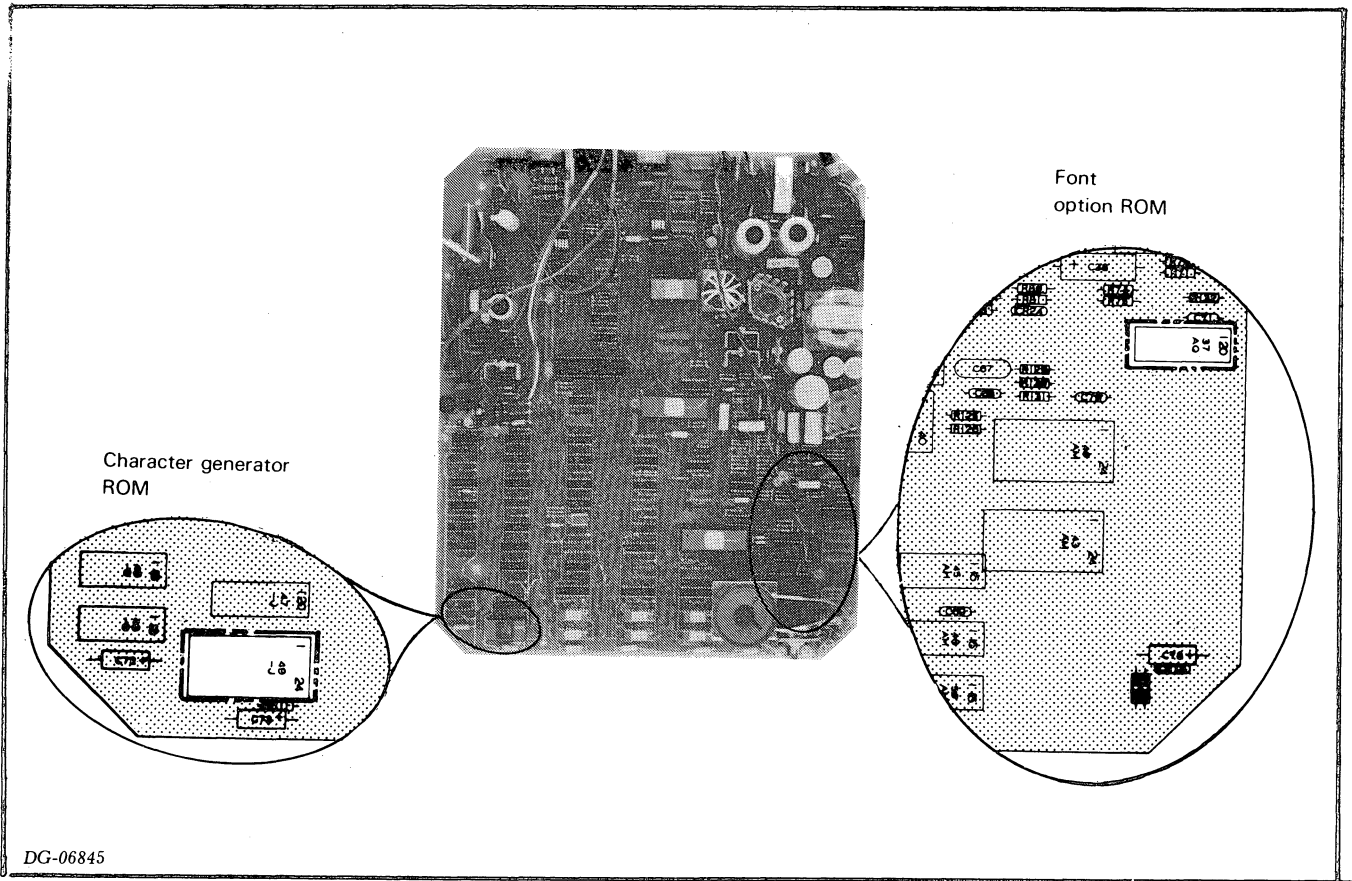

Figure 8.16 ROM locations



5. Make sure the power supply voltage and frequency select resistors on the new circuit board match the AC source being used (see figure 8.17).

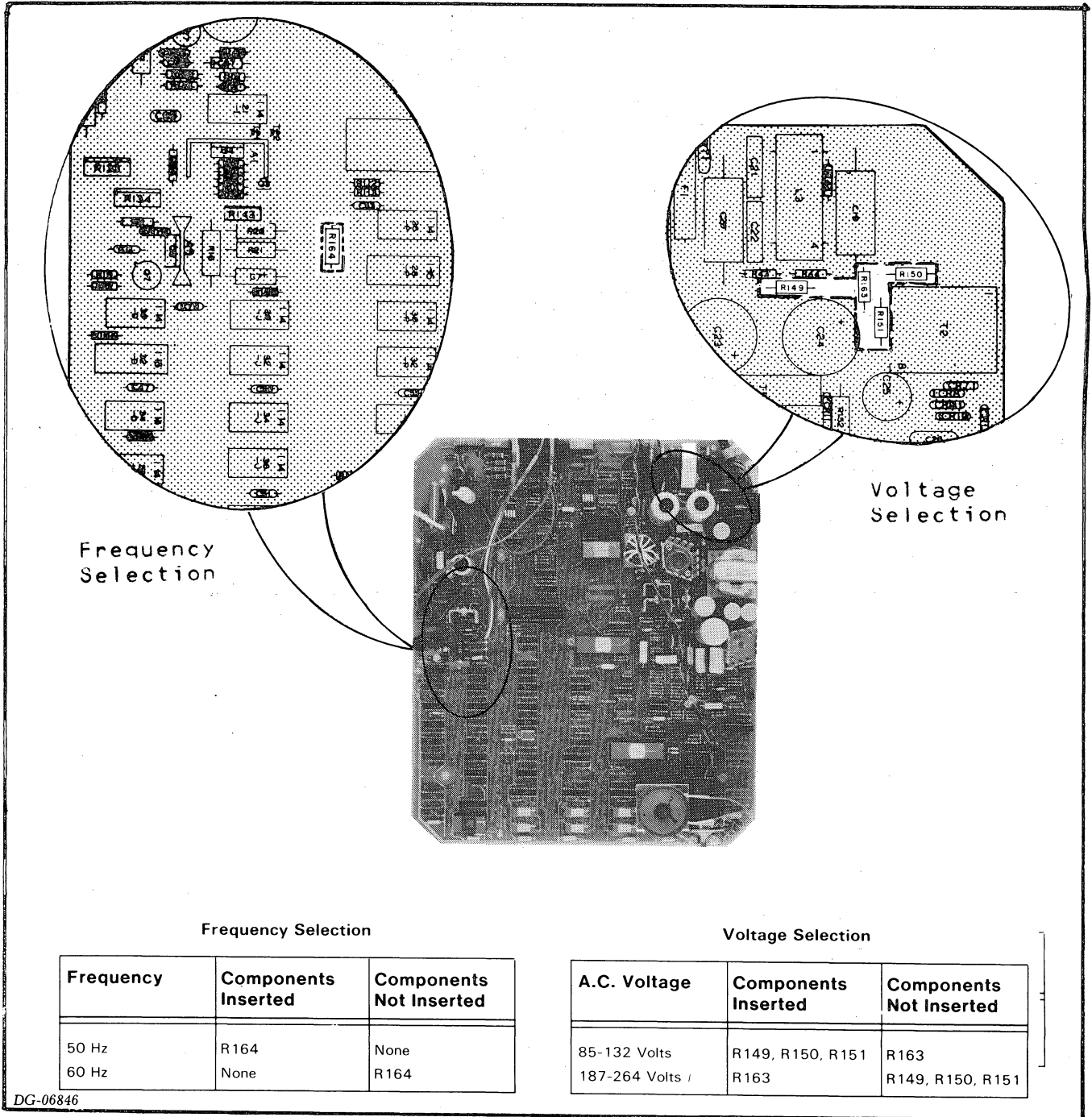

Figure 8.17 Power supply resistors

6. Make sure the communications interface and the split baud/printer option on the new circuit board are tailored correctly (see figures 3.4 and 3.5, respectively).
7. Slide the new circuit board in from the rear and position it over the screw holes. Make sure the rear end of the board is under the 2 tabs that hold it down. Replace the 4 hex screws that secure the board to the case.
8. Replace the two cardboard covers removed from the original board (see figure 8.15).
9. Plug in the power cord and turn on the power.
10. Make the following adjustments using the procedures outlined in chapter 9: +5V, screen width, bias, screen height, and focus.

#### REPLACING THE CRT/YOKE ASSEMBLY

**CAUTION:** Always wear protective eyeglasses when handling a CRT. Never pick up a CRT by its neck or let anything hit the neck because the neck may break and cause the tube to implode. Use both hands when handling the tube and grasp it by the sides near the front.

1. Remove the 4 screws, washers, and grommets fastening the CRT/yoke assembly to its bracket. Start with the two bottom screws (see figure 8.18).

**WARNING:** Do not let the CRT fall back on its neck or it may implode.

2. Remove the CRT/yoke assembly from its bracket and place it in a safe area.
3. BEFORE REMOVING THE NEW CRT/YOKE ASSEMBLY FROM ITS SHIPPING BOX, DISCHARGE THE CRT as follows:
  - Fasten one end of a clip lead to an insulated screwdriver.
  - Clip the other end of the lead to the CRT support bracket.
  - Touch the screwdriver blade to the high voltage anode on the side of the CRT.
4. Position the new CRT/yoke assembly in the bracket with the anode connectors facing upwards (see figure 8.18). Then, replace the 4 screws, washers, and grommets, starting with the two top screws.

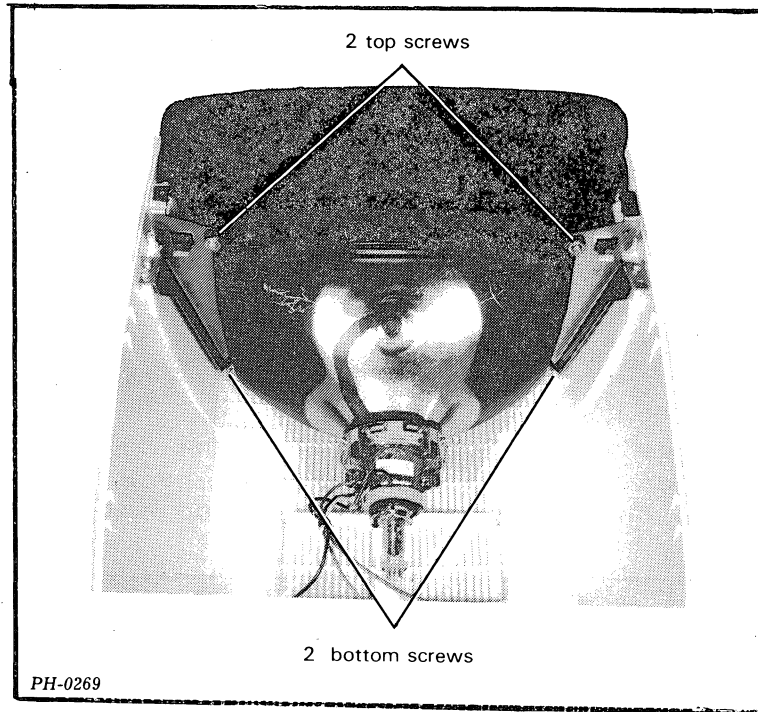

Figure 8.18 Removing the CRT

5. Place the defective CRT/yoke assembly in the packing box previously occupied by the new CRT/yoke assembly.
6. Remove the defective CRT from the customer's site and bleed the vacuum to prevent any chance of implosion.

#### BLEEDING CRT VACUUM

Before disposing of a defective CRT, bleed the vacuum as follows.

**WARNING:** Always wear safety glasses and gloves before bleeding the vacuum.

1. Cut a small hole in the box containing the CRT so you can gain access to the neck with diagonal cutting pliers.
2. Seal the box using masking tape.
3. Make sure the area is clear of bystanders.
4. Using diagonal cutters, reach through the hole in the box and cut the glass nipple protruding from the neck of the tube.

## CONNECTING THE BOARD AND THE CRT/YOKE ASSEMBLY

1. Place the top of the case into the hinges on the bottom of the case. Lower the top until the support rods latch.
2. Plug the four yoke wires into the circuit board as follows (see figure 8.19):

Black wire to J4  
Yellow wire to J5  
Blue wire to J6  
Red wire to J7

3. Observing the proper key alignment, plug the six-wire connector from the circuit board onto the rear of the CRT neck (see figure 8.19). The connector will only go on one way, so do not force it.

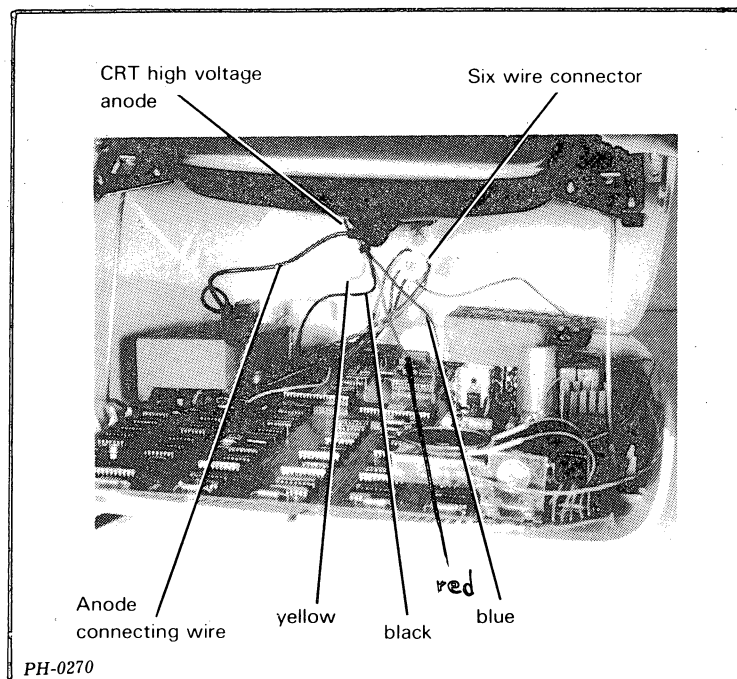

Figure 8.19 CRT/yoke wires

4. DISCHARGE THE HIGH VOLTAGE IN THE CRT as follows (see figure 8.20):
  - Fasten one end of a clip lead to an insulated flat-blade screwdriver.
  - Clip the other end of the lead to the CRT support bracket.
  - Carefully push the screwdriver blade under the rubber anode cap. The blade must touch the wires under the cap to short the CRT. You will hear a snap when this happens.
  - Repeat the discharge procedure several times until no snap is heard.

5. Plug the CRT anode wire into the CRT as follows (see figure 8.19):

- Fold the rubber cap back to expose the two wires.
- Holding the cap between your thumb and index finger, insert one wire into the hole at a time.
- Press the cap against the CRT.

6. Reattach the two ground wires from the main board to the CRT support bracket (see figure 8.21).

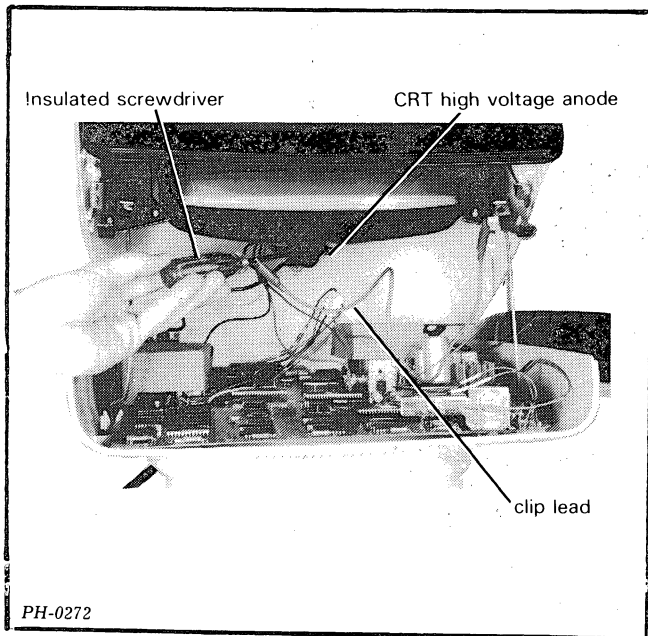

Figure 8.20 Discharging the CRT

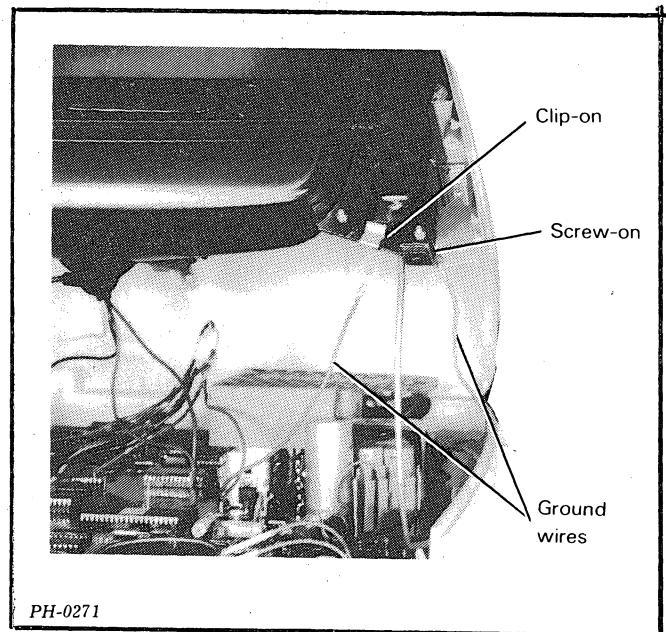

Figure 8.21 Ground wires

7. Close the case following the procedure on page 8-2.
8. Plug the following cables into the rear of the display (see figure 8.22):
  - Keyboard cable
  - Communications device cable
  - Printer cable (if present)
9. Plug in the power cord and turn on the power.

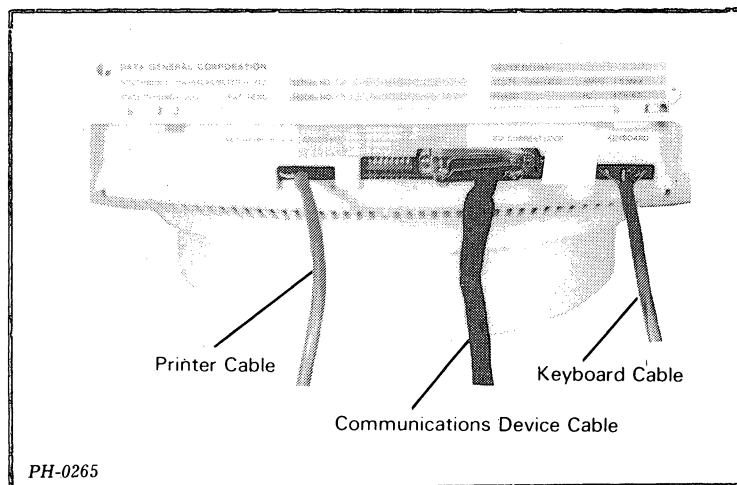

Figure 8.22 External cables

## CHAPTER 9 ADJUSTING THE DISPLAY

This chapter tells how to adjust the +5V supply and four screen parameters: width, height, bias, and focus. Since making one adjustment affects the other adjustments, always make the adjustments in the following order:

1. +5V
2. width
3. bias
4. Height
5. Focus

Following this sequence results in the easiest and most accurate adjustments.

Since the adjustments require access to the potentiometers located on the printed circuit board, the case must be open. If the case is not open, open it as described on page 8-2. After the adjustments are done, close the case as described on page 8-2.

**WARNING:** The adjustments must be performed with the the case open and the terminal powered up. Dangerous voltages are exposed and all standard safety precautions should be observed.

## +5V SUPPLY ADJUSTMENT

This is the most important adjustment in the terminal because it provides the operating voltages for all major components. The +5V supply also serves as a reference voltage for the width control.

1. Connect a digital voltmeter (DVM) across the +5V monitor points described below (see figure 9.1). Be careful not to short any of the nearby components.
  - ⊙ The positive DVM lead to the positive (front) end of capacitor C32.
  - ⊙ The negative DVM lead to the negative (front) end of capacitor C31.
2. Adjust the +5 potentiometer for a reading of 5.10 +/- 0.05 volts.
3. Disconnect the voltmeter.

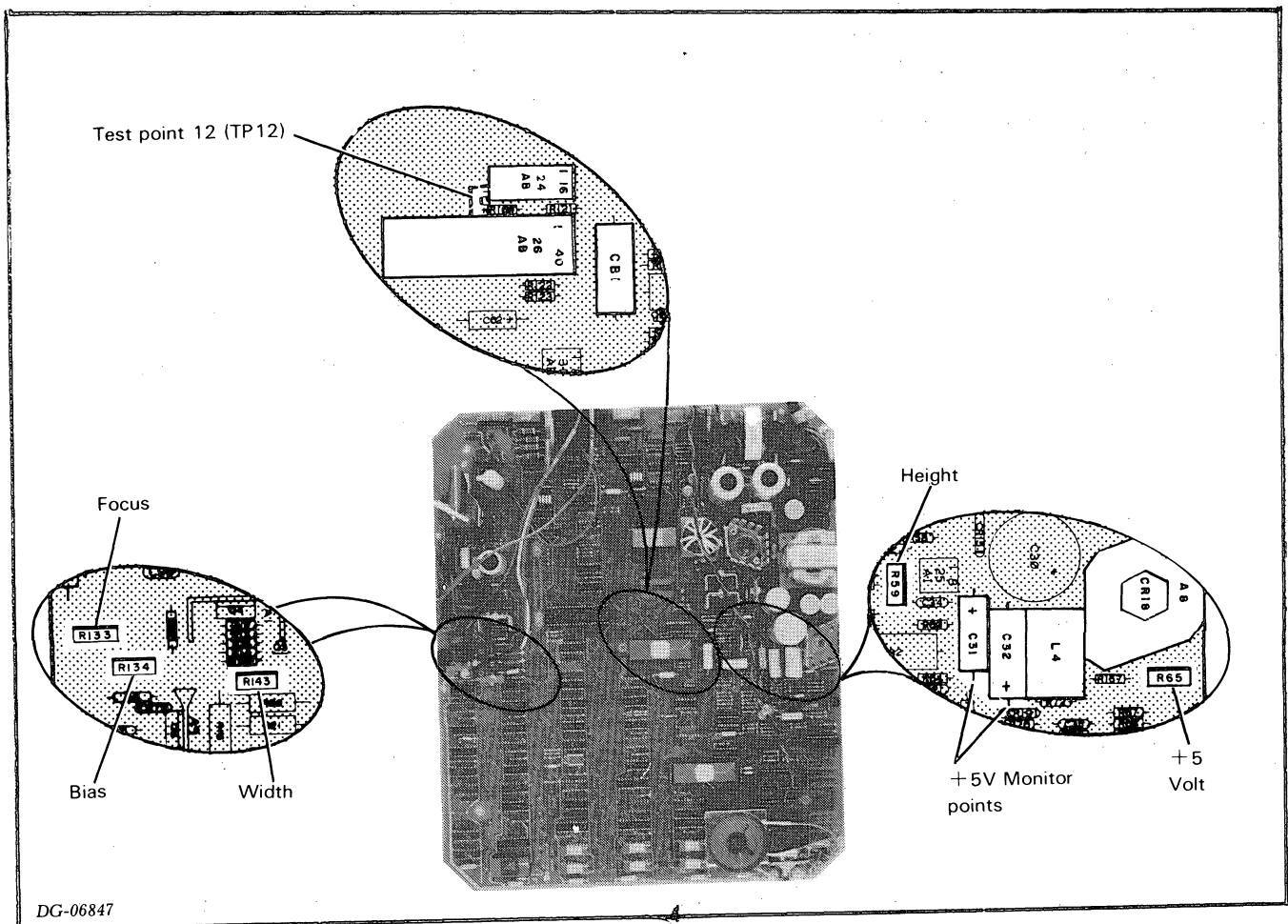

Figure 9.1 +5V monitor points and potentiometer locations



## SCREEN WIDTH ADJUSTMENT

This adjustment sets the correct width of the viewing area. As a side effect, it also changes the height of the viewing area.

1. Fill the screen with characters by temporarily shorting test point 12 (TP12) to the CRT support bracket (see figure 9.1).
2. Adjust the width potentiometer so that the width of a full line of characters is 8.5 +/- 0.25 inches, 21.6 +/- 0.6 centimeters (see figure 9.1).

## BIAS ADJUSTMENT

This adjustment sets the black level of the viewing area. The correct setting of the potentiometer will blank the screen completely when the brightness control is all the way down.

1. Turn the brightness control all the way down (counter-clockwise).
2. Adjust the bias potentiometer clockwise until a light background begins to appear, then turn it in the opposite direction until it disappears (see figure 9.1).
3. Turn up the brightness control until characters are displayed brightly.

## SCREEN HEIGHT ADJUSTMENT

This adjustment sets the correct height of the viewing area.

1. Fill the screen with characters by temporarily shorting test point 12 (TP12) to the CRT support bracket (see figure 9.1).
2. Adjust the height potentiometer so that the height of a full column of characters in the middle of the screen is 5.5 +/- 0.25 inches, (14.0 +/- 0.6 centimeters); see figure 9.1.

## FOCUS ADJUSTMENT

The focus adjustment sets the optimum electrical focus for viewing.

1. Fill the screen with characters by temporarily shorting test point 12 (TP12) to the CRT support bracket (see figure 9.1).
2. Turn the brightness control up until the characters appear brightly.
3. Adjust the focus potentiometer so that the characters located halfway between the center and the corners of the screen are focused as best as possible (see figure 9.1).



## CURRENT LOOP CONNECTION

The 20mA current loop interface can be either active or passive. In an active connection, the terminal supplies the energy to drive the terminal's interface; in a passive connection, the computer or communications system supplies the energy.

The same 25-pin Cannon connector used for EIA connections joins the terminal's current loop interface to a computer via a current loop cable. Refer to figure C.1. Figure C.3 lists the current loop cables that are available from Data General and identifies the pin connections.

When using a cable not shown in Figure C.3, select a passive or active connection by wiring the terminal end of the cable as shown in figure C.4.

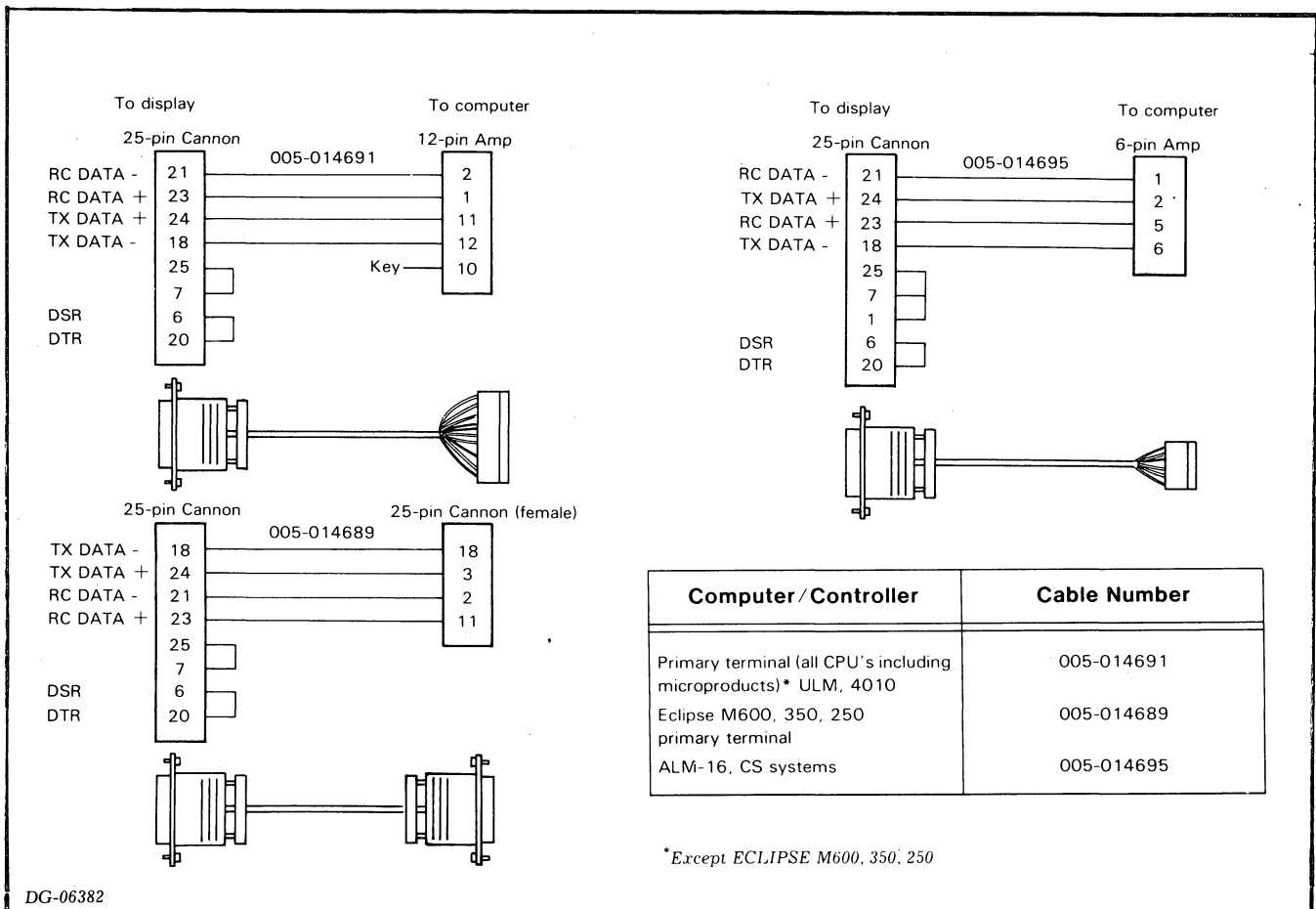
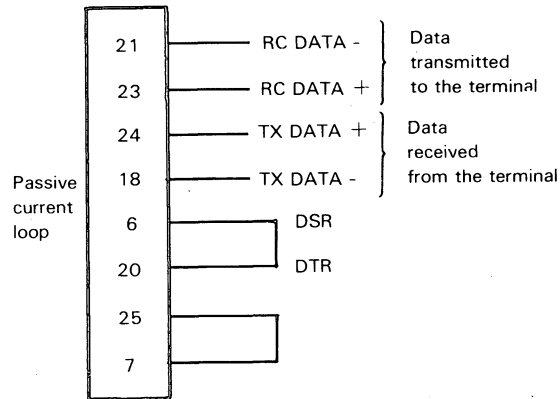
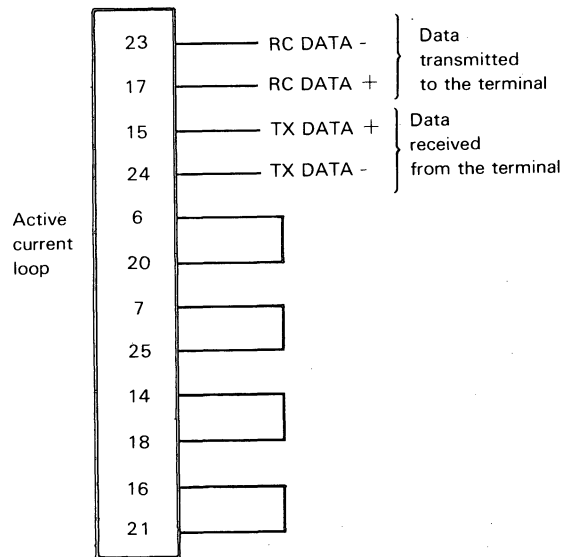

Figure C.3 20mA current loop interface cables

Use the following configuration to select a passive current loop connection (All Data General current loop controllers use this type of connection).



Use the following configuration to select an active current loop configuration.



DG-06383

Figure C.4. 20mA current loop external cabling

## PRINTER CONNECTION

The printer interface is joined to the printer via the 7-pin connector shown in Figure C.5 and an EIA RS-232-C cable. Figure C.6 shows the Data General cable that connects a D100/D200 display terminal to a DASHER TP1 or TP2 printer.

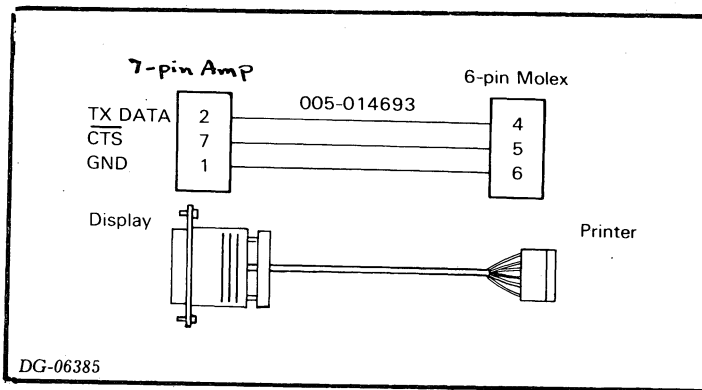

Figure C.5 Printer option cable

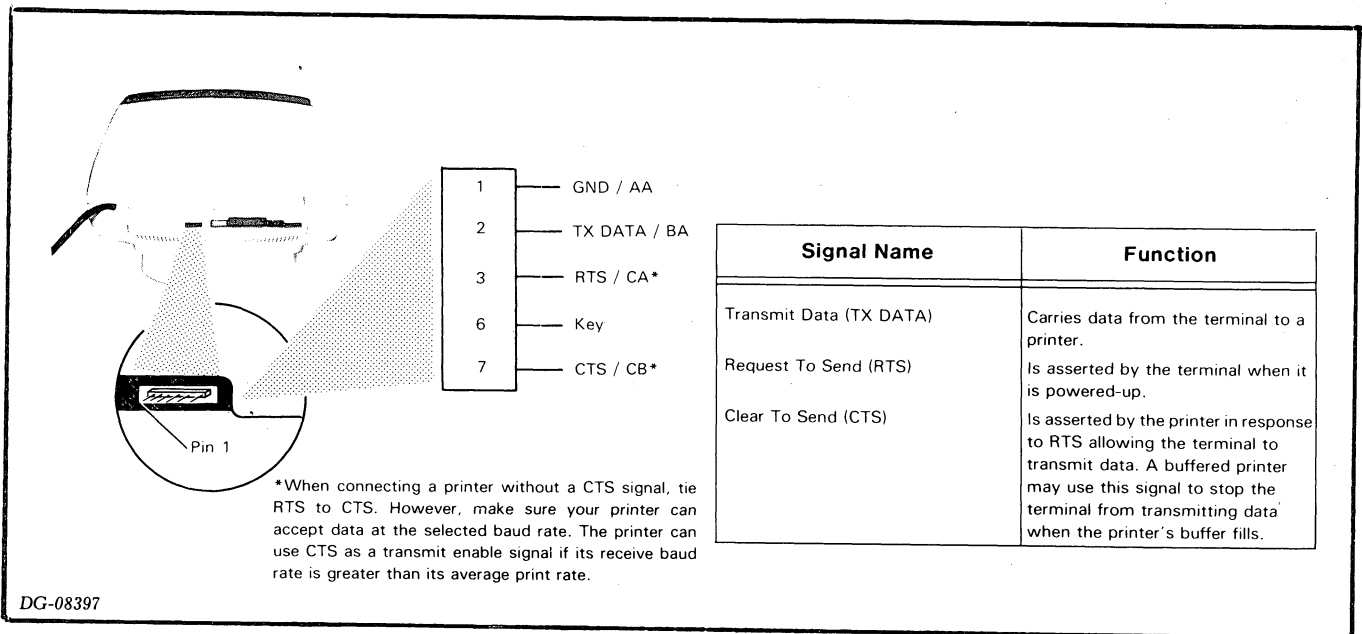

Figure C.6 Printer connector



# Engineering Publications Comment Form

Please help us improve our future publications by answering the questions below. Use the space provided for your comments.

Title: \_\_\_\_\_

Document No. \_\_\_\_\_

Yes	No		
<input type="checkbox"/>	<input type="checkbox"/>	Is this manual easy to read?	<input type="radio"/> You (can, cannot) find things easily. <input type="radio"/> Other: <input type="radio"/> Language (is, is not) appropriate. <input type="radio"/> Technical terms (are, are not) defined as needed.
		In what ways do you find this manual useful?	<input type="radio"/> Learning to use the equipment <input type="radio"/> To instruct a class. <input type="radio"/> As a reference <input type="radio"/> Other: <input type="radio"/> As an introduction to the product
<input type="checkbox"/>	<input type="checkbox"/>	Do the illustrations help you?	<input type="radio"/> Visuals (are, are not) well designed. <input type="radio"/> Labels and captions (are, are not) clear. <input type="radio"/> Other:
<input type="checkbox"/>	<input type="checkbox"/>	Does the manual tell you all you need to know? What additional information would you like?	
<input type="checkbox"/>	<input type="checkbox"/>	Is the information accurate? (If not please specify with page number and paragraph.)	

Name: \_\_\_\_\_ Title: \_\_\_\_\_

Company: \_\_\_\_\_ Division: \_\_\_\_\_

Address: \_\_\_\_\_ City: \_\_\_\_\_

State: \_\_\_\_\_ Zip: \_\_\_\_\_ Telephone: \_\_\_\_\_ Date: \_\_\_\_\_

FOLD

FOLD

STAPLE

STAPLE

FOLD

FOLD



NO POSTAGE  
NECESSARY  
IF MAILED  
IN THE  
UNITED STATES

**BUSINESS REPLY MAIL**  
FIRST CLASS PERMIT NO. 26 SOUTHBORO, MA. 01772

Postage will be paid by addressee:

 **Data General**  
ATTN: ENGINEERING PUBLICATIONS  
Southboro, Massachusetts 01772

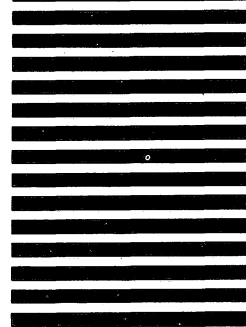



# USERS group

## Installation Membership Form

Name \_\_\_\_\_ Position \_\_\_\_\_ Date \_\_\_\_\_

Company, Organization or School \_\_\_\_\_

Address \_\_\_\_\_ City \_\_\_\_\_ State \_\_\_\_\_ Zip \_\_\_\_\_

Telephone: Area Code \_\_\_\_\_ No. \_\_\_\_\_ Ext. \_\_\_\_\_

**1. Account Category**

OEM  
 End User  
 System House  
 Government

**5. Mode of Operation**

Batch (Central)  
 Batch (Via RJE)  
 On-Line Interactive

**2. Hardware**

	Qty. Installed	Qty. On Order
M/600		
C/350, C/330, C/300		
S/250, S/230, S/200		
S/130		
AP/130		
CS Series		
N3/D		
Other NOVA		
microNOVA		
Other _____		
(Specify) _____		
_____		

**6. Communications**

RSTCP       CAM  
 HASP       4025  
 RJE80       Other  
 SAM

Specify \_\_\_\_\_

\_\_\_\_\_

**3. Software**

AOS       RDOS  
 DOS       RTOS  
 SOS       Other

Specify \_\_\_\_\_

\_\_\_\_\_

**7. Application Description**

○ \_\_\_\_\_

\_\_\_\_\_

\_\_\_\_\_

\_\_\_\_\_

\_\_\_\_\_

**4. Languages**

Algol       Assembler  
 DG/L       Interactive  
 Cobol       Fortran  
 ECLIPSE Cobol       RPG II  
 Business BASIC       PL/1  
 BASIC       Other

Specify \_\_\_\_\_

\_\_\_\_\_

**8. Purchase**

From whom was your machine(s) purchased?

Data General Corp.  
 Other  
Specify \_\_\_\_\_

\_\_\_\_\_

**9. Users Group**

Are you interested in joining a special interest or regional Data General Users Group?

○ \_\_\_\_\_

\_\_\_\_\_

FOLD

FOLD

STAPLE

STAPLE

FOLD

FOLD



**BUSINESS REPLY MAIL**  
FIRST CLASS PERMIT NO. 26 SOUTHBORO, MA. 01772

Postage will be paid by addressee:

 **Data General**

ATTN: Users Group Coordinator

Southboro, Massachusetts 01772

NO POSTAGE  
NECESSARY  
IF MAILED  
IN THE  
UNITED STATES

