

# **SKM SERIES**

## **Disk/Tape Subsystems**

### **Technical Manual**

**Document No: 600-0537-00**

**Revision: B**

**Date: September 1991**

# **NOTICE**

Zetaco, Inc. has prepared this Technical Manual for use by Zetaco personnel and its customers to assist in the installation, operation and maintenance of the SKM Disk/Tape Subsystem. The information contained herein is the property of Zetaco and shall not be reproduced in whole nor in part without prior written approval of Zetaco.

Zetaco makes every effort to produce quality products and documentation; however, the reader must be cautioned that changes may be made to the product not reflected in the supplied documentation. If you find errors or omissions, please notify Zetaco to remedy the problem. You may mail in the form on the last page of this manual, postage paid, with your comments. Zetaco shall not be responsible for any damages (including consequential) caused by reliance on this material as presented.

Copyright 1991, Zetaco, Inc. All rights reserved.  
Zetaco is a division of Carlisle Systems Group Incorporated.

MVSYSTEMX, CONTEST, UDKV RELI, MLTT RELI, MTJ, and DPJ, are trade names of Data General Corporation.

Exabyte is a trade name of Exabyte Corporation.

SKM is a trade name of Zetaco, Inc.

## Warning

This equipment generates, uses, and can radiate radio frequency energy and if not installed and used in accordance with the instructions manual, may cause interference to radio communications. It has been tested and found to comply with the limits for a Class A computing device pursuant to Subpart J of Part 15 of FCC Rules, which are designed to provide reasonable protection against such interference when operated in a commercial environment. Operation of this equipment in a residential area is likely to cause interference in which case the user at his own expense will be required to take whatever measures may be required to correct the interference.

## Warning

This digital apparatus does not exceed the CLASS A limits for radio noise for digital apparatus set out in the Radio Interference Regulations of the Canadian Department of Communications.

Le présent appareil numérique n'émet pas de bruits radioélectriques dépassant les limites applicables aux appareils numériques de la classe A prescrites dans le Règlement sur le brouillage radioélectrique édicté par le ministère des Communications du Canada.



# Preface

---

This manual contains information regarding installation, testing, and operation of the ZETACO SKM Disk/Tape Subsystem. The technical contents have been written with the following assumptions in mind:

- 1) *You have a working knowledge of Data General Minicomputers, operating systems, and diagnostic and utility software;*
- 2) *You have access to full hardware and software documentation for your particular system;*
- 3) *You are familiar with standard installation, power, grounding, and peripheral cabling procedures.*

The information in this manual is organized into the following chapters:

## **Chapter 1 - Product Overview**

SKM Disk/Tape Subsystem features, capabilities, specifications, power and interface requirements.

## **Chapter 2 - Installation**

Hardware and software procedures required to install and test the SKM Disk/Tape Subsystem.

## **Chapter 3 - Trouble-shooting**

How to analyze problems; how to get help.

## **Chapter 4 - Usage Guidelines**

Information on effectively using the SKM Disk/Tape Subsystem - backing up programs, caring for tapes and tape drives, and installing add-on disk and tape drives.

## **Appendix A - Peripheral Specifications**

## **Appendix B - Controller LEDs**



# *Table of Contents*

## *Chapter 1 - Product Overview*

1.0	Introduction .....	1-1
	<i>Features</i> .....	1-1
1.1	Controller Specifications .....	1-2
	<i>Computer Interface</i> .....	1-3
	<i>BMC Bus Cables</i> .....	1-3
	<i>Device Interface</i> .....	1-3
	<i>Mechanical</i> .....	1-3
	<i>Power Requirements</i> .....	1-3
	<i>Environmental</i> .....	1-3
1.2	Drive Enclosure Specifications .....	1-4
	<i>Mechanical</i> .....	1-4
	<i>Power Input</i> .....	1-4
	<i>Available Power Output per Drive</i> .....	1-4
	<i>Environmental</i> .....	1-5
1.3	Peripheral Specifications .....	1-6
1.4	Regulatory & Safety Agency Standards .....	1-6
1.5	Cabling .....	1-7
	<i>Internal Cabling</i> .....	1-7
	<i>External Cabling</i> .....	1-7

## **Chapter 2 - Installation**

2.0	Before You Begin Installation . . . . .	2-1
	<i>Overview of the Installation Process</i> . . . . .	2-1
2.1	Hardware Installation Procedure . . . . .	2-2
	<i>What to do if there is damage</i> . . . . .	2-3
2.11	Selecting a Slot & Making it Functional . . . . .	2-4
	<i>Single vs. Dual Controller Installation</i> . . . . .	2-4
	<i>Slot Selected Must be I/O ONLY</i> . . . . .	2-4
	<i>Availability to BMC</i> . . . . .	2-5
	<i>More on Slot Selection</i> . . . . .	2-6
	<i>Priority Must be Maintained</i> . . . . .	2-7
	<i>Pin-to-Pin Connections</i> . . . . .	2-7
2.12	Setting Controller Switches . . . . .	2-8
	<i>Information Regarding Device Code Addresses</i> . . . . .	2-8
	<i>Setting the Device Code Address Switch</i> <i>on SCZ-5 Controllers</i> . . . . .	2-8
	<i>Setting the Device Code Address Switch</i> <i>on SCZ-3 and SCZ-4 Controllers</i> . . . . .	2-9
	<i>When to Use the E<sup>2</sup>PROM Write Disable</i> . . . . .	2-10
	<i>Using Configuration Over-ride (SCZ-4</i> <i>and SCZ-5 only)</i> . . . . .	2-10
2.13	Jumpers . . . . .	2-11
2.14	Installing Controllers and Paddleboards . . . . .	2-12
	<i>How to Properly Install a Controller into its Slot</i> . . . . .	2-12
	<i>How to Properly Install a Paddleboard</i> . . . . .	2-13
2.15	Peripheral Enclosure Installation . . . . .	2-14
	<i>Connecting Power to the Enclosure</i> . . . . .	2-16



2.16	Connecting the Subsystem Cabling	2-17
	<i>Installing the Internal Cables</i>	2-17
	<i>Attaching the External Cables</i>	2-18
	<i>Attach the SCSI Terminator Plugs</i>	2-21
	<i>Installing the BMC Cables</i>	2-21
	<i>Providing Termination for the BMC Bus</i>	2-21
2.2	How to Check for Normal Power-up	2-22
2.3	The Software Installation Procedure	2-24
	<i>Have Enough Reference Material Ready</i>	2-24
	<i>System Requirements for Installation</i>	2-25
2.31	Using the Support Package Tapes	2-26
	<i>What the Files on the Tapes are For</i>	2-26
	<i>SysAdmin Tools added to Support Tape</i>	2-26
	<i>How to Access the Tapes</i>	2-27
2.32	Using the Configurator Programs to Set Options	2-29
2.33	More Information on Which Options to Change	2-30
	<i>BMC Options</i>	2-30
	<i>Selecting SCSI ID for the Controller</i>	2-32
2.34	Using the Disk Initializer Program	2-33
	<i>Running Stand-alone Disk Initializer</i>	2-33
	<i>Running Stand-among Disk Initializer (SCZ-5 Only)</i>	2-33
	<i>When to Use This Program</i>	2-34
	<i>The Program Sequence to Follow</i>	2-35
	<i>Choosing Disk Initializer Options for Each Unit</i>	2-36
	<i>Analyze Disk</i>	2-36
	<i>Relocate Blocks</i>	2-37
	<i>Microcode Install Only</i>	2-38
	<i>Format Only</i>	2-38

	<i>INIT Soft Error Log</i> .....	2-39
	<i>If You Are Upgrading an SCZ-3 to an SCZ-5 Controller</i> ..	2-39
2.35	<b>Using the SCZ5M Monitor Program</b> .....	2-40
	<i>SCZ-5 Monitor Help</i> .....	2-40
	<i>Status Definitions</i> .....	2-41
2.36	<b>Using the REWUL Rewind/Unload Program</b> .....	2-42
	<i>SCZ-5 Rewind/Unload Help</i> .....	2-42
2.37	<b>Using the SCZ5TF Tape Format Program</b> .....	2-43
	<i>SCZ-5 Tape Format Help</i> .....	2-43
2.38	<b>Using the Reliability Programs</b> .....	2-45
	<i>Choosing the Program Global Parameters</i> .....	2-45
	<i>The Program Sequence to Follow</i> .....	2-46
2.39	<b>Summary of Reliability Commands</b> .....	2-47
	<i>The Main Menu Options</i> .....	2-47
2.40	<b>Preparation Under the Operating System</b> .....	2-49
	<i>Why Run VSGEN?</i> .....	2-49
	<i>What to Know Before You Run VSGEN</i> .....	2-49
	<i>Loading Support Tape Files Onto an AOS/VS</i>	
	<i>System Disk</i> .....	2-50
	<i>Standard CLI Commands to Load the "DUMP" File</i> .....	2-50
	<i>Running Stand-alone Programs</i> .....	2-51
	<i>Running Stand-among Programs</i> .....	2-51

### ***Chapter 3 - Trouble-shooting***

3.0	<b>Trouble-shooting Subsystem Errors</b> .....	3-1
	<i>Power-up Problems</i> .....	3-1
	<i>Test Programs to Use</i> .....	3-1
	<i>Field Support</i> .....	3-1

3.1	Controller Faults Reported by Led Error Codes . . . . .	3-2
	<i>Self-Test</i> . . . . .	3-2
	<i>If Self-Test Fails</i> . . . . .	3-3
	<i>Error Codes Displayed During System Operation</i> . . . . .	3-3
3.11	Identifying the Self-test Failure . . . . .	3-5
	<i>Host Side Error Decoding</i> . . . . .	3-5
	<i>SCSI Side Error Decoding</i> . . . . .	3-5
3.12	Error Codes For SCZ-3 and SCZ-4 Controllers . . . . .	3-7
	<i>Host Side Errors (Right-Most LEDs)</i> . . . . .	3-7
	<i>SCSI Side Errors (Left-Most LEDs)</i> . . . . .	3-7
3.13	Error Codes For the SCZ-5 Controller . . . . .	3-8
	<i>Host Side Errors</i> . . . . .	3-8
	<i>SCSI Side Errors</i> . . . . .	3-9
	<i>Reconfigure Instructions (SCZ-5 Only)</i> . . . . .	3-10
3.2	Peripheral Enclosure Faults . . . . .	3-11
3.3	8mm Tape Drive Faults . . . . .	3-12
	<i>Normal Power-Up Initialization</i> . . . . .	3-12
	<i>Self-Test That Does Not Complete</i> . . . . .	3-12
3.4	Disk Drive Faults . . . . .	3-14
3.5	Problems Running the Utility Programs . . . . .	3-15
	<i>Assumptions About the Installation</i> . . . . .	3-15
	<i>Two Common Difficulties When Running the Programs</i> . . . . .	3-15
3.6	Types of Error Messages From Reliability . . . . .	3-17
	<i>Description of PIO and CB Error Reporting</i> . . . . .	3-17
	<i>Tape Hard Error Messages</i> . . . . .	3-19
	<i>Data Compare Errors Can also Occur</i> . . . . .	3-20

3.7	Error Messages From the System . . . . .	3-21
	<i>Recovering from a PANIC</i> . . . . .	3-21
	<i>Using MVSYSSTEMX</i> . . . . .	3-21
	<i>Using CONTEST</i> . . . . .	3-22
	<i>System Error without PANIC Crash</i> . . . . .	3-22
3.8	Interpreting Disk and Tape Commands and Status . . .	3-23
3.81	Tape Status . . . . .	3-23
	<i>Interpreting MTJ, CB, &amp; PIO Status</i> . . . . .	3-23
	<i>CB Status Meaning</i> . . . . .	3-23
	<i>Tape Error Code Word</i> . . . . .	3-24
	<i>PIO Status Meaning</i> . . . . .	3-25
3.82	Disk Commands and Status . . . . .	3-27
	<i>Disk Commands</i> . . . . .	3-27
	<i>Status Information</i> . . . . .	3-27
	<i>CB Status Implementation</i> . . . . .	3-29
	<i>Disk error Code Word</i> . . . . .	3-31
3.9	Help is Available for Problem Situations . . . . .	3-32
	<i>You Can Use the Customer Support Hotline</i> . . . . .	3-32
	<i>How to Get a Return Material Authorization (RMA)</i> . . . .	3-32
	<i>Information About Warranty</i> . . . . .	3-33

## ***Chapter 4 - Usage Guidelines***

4.1	Using the Tape Subsystem Efficiently . . . . .	4-1
4.11	Setting up a Back-up Program . . . . .	4-2
	<i>A Word About Block Size</i> . . . . .	4-2
	<i>Writing a Back-up Macro</i> . . . . .	4-2
	<i>Example 4.1a Partial AOS/VS BACK_UP_FILE</i> . . . . .	4-3

4.12	Commands MTJ Understands .....	4-4
	<i>Tape Commands in AOS/VS</i> .....	4-4
	<i>Creating a Physical Copy of Your Disk in AOS/VS</i> .....	4-5
4.13	Caring for the Tapes & Tape Drive .....	4-6
	<i>Which Tapes to Use</i> .....	4-6
	<i>Advice on Storing Tapes</i> .....	4-6
	<i>Advice on Handling &amp; Using Tapes</i> .....	4-6
	<i>Advice on Cleaning the Tape Drive</i> .....	4-7
4.2	Installing Add-On Disk and Tape Drives .....	4-8
	<i>General Procedure</i> .....	4-8
	<i>How Many Drives can be Added?</i> .....	4-8
4.21	Setting SCSI ID Addresses .....	4-9
4.22	Removing SCSI Terminators From Disk Drives .....	4-11
4.23	Installing Add-on Drives Into The Enclosure .....	4-12
4.24	Installing Add-on Enclosures .....	4-15
4.25	Cabling Issues .....	4-16
 <i>Appendix A - Peripheral Specifications</i> .....		 A-1
A.1	Exabyte EXB-8200 and EXB-8500 8mm Tape Drives ...	A-2
A.11	Specifications .....	A-2
	<i>Environmental</i> .....	A-2
A.12	Setting SCSI ID Address .....	A-3
A.13	The Write Protect Tab .....	A-4
A.14	Cartridge Tape LOAD & UNLOAD Procedures .....	A-5
A.2	Seagate Wren Runner ST4385N (94181-385H/M) .....	A-6

A.21	Specifications	A-6
A.22	Setting SCSI ID Address	A-7
A.3	Seagate Wren V ST4702N (94181-702/M)	A-8
A.31	Specifications	A-8
A.32	Setting SCSI ID Address	A-9
A.4	Seagate Wren Runner II ST4767N (94601-767H/M)	A-10
A.41	Specifications	A-10
A.42	Setting SCSI ID Address	A-11
A.5	Seagate Wren VII ST41200N (94601-12G/M)	A-12
A.51	Specifications	A-12
A.52	Setting SCSI ID Address	A-13
A.6	Seagate Elite ST41600N	A-24
A.7	Wangdat 1300 and 2000 4mm Tape Drives	A-29

***Appendix B - Controller LEDs*** . . . . . ***B-1***

B.1	LED Indicators On SCZ-3 and SCZ-4 Controllers	B-2
B.2	LED Indicators On the SCZ-5 Controller	B-5

***List of Tables***

2.11	Identification of I/O ONLY Slots	2-5
2.2	Hardware Installation Checklist	2-23
3.1	What The Controller LEDs Mean	3-3
3.3	Definition of Tape Drive LEDs	3-13
3.5	Common Problems/Solutions Using Utility Programs	3-16
3.81a	Meaning of Tape CB Status	3-23
3.81b	Meaning of Tape CB Error	3-24
3.81c	Meaning of Tape CB Unit Status	3-24
3.81d	Meaning of Tape PIO Register C	3-25
3.81e	Meaning of Tape PIO Register B	3-26
3.82a	Disk PIO Command Implementation	3-27
3.82b	Disk Control Block Command Implementation	3-27
3.82c	Disk PIO Register Status Implementation	3-28
3.82d	Disk PIO Register B Status	3-29

3.82e	Disk CB Status Word	3-29
3.82f	Disk CB Error Word	3-30
3.82g	Disk Unit Status Word	3-30
4.21a	SCSI ID Assignments for SCZ-3/SCZ-4 Subsystems	4-11
4.21b	SCSI ID Assignments for SCZ-5 Subsystems	4-11
A.12	EXB-8200 8mm ID Switch Settings	A-3

### *List of Figures*

1.2a	Peripheral Enclosure Controls and Indicators	1-5
1.2b	Single Bus Peripheral Enclosure Rear View	1-5
1.2c	Dual Bus Peripheral Enclosure Rear View	1-6
2.11	Backplane Priority Jumpers	2-7
2.12	Device Code Switches Located on Controller	2-9
2.14	Installing the Paddleboard and Controller	2-12
2.15	Enclosure Slide Assembly	2-15
2.16a	Controller Cabling Diagram	2-17
2.16b	Single Bus Peripheral Enclosure Cabling	2-19
2.16c	Dual Bus Peripheral Enclosure Cabling	2-20
2.35	Support Tape Menu	2-28
2.36	Main Menu of Reliability Test Program	2-45
3.1a	SCZ-3 and SCZ-4 LED Status Indicators	3-4
3.1b	SCZ-5 LED Status Indicators	3-4
3.11	Getting an Octal Number From LEDs	3-6
3.6a	CB Type Error Report - Tape	3-17
3.6b	CB Type Error Report - Disk	3-18
3.6c	PIO Type Error Report - Tape	3-18
3.6d	PIO Type Error Report - Disk	3-19
3.6e	RELI Data Compare Error - Tape	3-20
3.6f	RELI Data Compare Error - Disk	3-20
4.21	Disk and Tape Drive Placement	4-9
4.23	Add-on Drive Installation	4-13
4.25	Multiple Enclosure Cable Length	4-16
A.12	SCSI ID Switches on EXB-8200 8mm Tape	A-3
A.13	Location of Write Protect Tab on 8mm Tape	A-4
A.22	Seagate ST4385N SCSI ID Jumpers	A-9
A.32	Seagate ST4702N SCSI ID Jumpers	A-13
A.42	Seagate ST4767N SCSI ID Jumpers	A-17
A.52	Seagate ST41200N SCSI ID Jumpers	A-21
A.62	Seagate ST41600N SCSI ID Jumpers	A-25

A.71a	Wang DAT Drive Connectors & Switches .....	A-29
A.71b	4mm DAT Cassette .....	A-30
B.1	SCZ-3 and SCZ-4 LED Status Indicators .....	B-2
B.2	SCZ-5 LED Status Indicators .....	B-5



## Product Overview

### *1.0 Introduction*

The SKM series Disk/Tape Subsystems combine Zetaco's high performance disk and tape controllers with high capacity disk and cartridge tape drives to provide a full data storage solution for Data General MV series systems. Standard 19 inch rack mount enclosures house up to four 5-1/4" disk and tape drives each. Zetaco SKM Subsystems are available in a wide variety of packaging options to give you the right combination of storage capacity, footprint and performance to meet your specific needs.

At the system level, the SKM subsystem utilizes the capabilities of Data General's MTJ and DPJ (Argus) software drivers. System performance benefits of the Argus driver are supported by the controller: memory resident control blocks, mapping responsibility, execution of linked control blocks. The subsystem executes all tape commands supported by the MTJ driver and disk commands supported by the DPJ driver.

The subsystem supports AOS/VS and AOS/VS-II operating systems unmodified. Since most differences between those two do not affect the functioning of the SKM subsystem, references to AOS/VS are intended to apply to both operating systems.

### *Features*

- Subsystems use the latest generation SCSI 5-1/4" disk and tape drives
- Standard 19" rack mount peripheral enclosure designed with emphasis on servicability
- Adherence to Common Command Set SCSI Protocol insures drive compatibility
- Controller command queueing for lower system overhead

Subsystem Features  
(continued)

- Controller features dual microprocessors with full parallel processing
- Controller self-test and error/status LED display

***1.1 Controller Specifications***

Drives per Controller: Up to 7 SCSI targets

Data Transfer Rate:

Synchronous . . . . . Up to 5 MB/sec

Asynchronous . . . . . Up to 3 MB/sec

Device Codes: Programmable or switch selectable

Interrupt Priority Mask Bit:

Disk . . . . .Bit 7

Tape . . . . .Bit 10

Bus Load: 1 unit load (any I/O ONLY slot)  
per controller

Data Channel Interface: Not Supported

Burst Multiplexor Channel Interface:

- . . . . Less than 1 STTL load
- . . . . 64ma drive at 0.7v
- . . . . Selectable BMC priorities 0 through 7
- . . . . Selectable burst rates from 2 to 256 16 bit words/access
- . . . . Selectable break count from 1 to 255 sync clock periods
- . . . . Supports BMC transfer rates equal to the fastest available BMC computers

Data Buffering: Two 256-word BMC buffers on each controller. Data buffering and caching also provided within the disk and tape drives.

Memory Address: 21 bits

***Computer Interface***

The controller is designed to operate only with the BMC and must be installed in an **I/O ONLY** slot of an MV computer. Its operating system must support the MTJ and DPJ drivers. Table 2.11 lists the Data General computers in which the controller will function, along with corresponding I/O ONLY slot numbers.

***BMC Bus Cables***

To transfer data over the BMC channel, a physical connection between the controller and the Data General BMC channel is required. This connection is made via two 40 conductor flat ribbon cables. Each has a single socket on one end (for the BMC controller) and multiple sockets (for multiple boards accessing the BMC) on the other.

***Device Interface***

The controller communicates with the devices via the SCSI interface. It can operate in synchronous or asynchronous mode. The controller is fully operational with either differential or single-ended drives. (Different paddleboards and cables are required for each type. They can never be mixed.)

***Mechanical***

Dimensions: 15" x 15" (37cm x 37cm)

***Power Requirements***

SCZ-5 controller: +5 vDC ( $\pm 5\%$ ) at 9 amps typical

SCZ-3 or SCZ-4  
controllers: +5 vDC ( $\pm 5\%$ ) at 8 amps typical  
per controller

***Environmental*****Operating Environment:**

Temperature: 0 to 55°C  
Relative Humidity: 10% to 90% (non-condensing)

**Non-Operating Environment:**

Temperature: -45 to +115°C  
Relative Humidity: 10% to 90% (non-condensing)

Exceeds all MV temperature and humidity specifications.

***1.2 Drive  
Enclosure  
Specifications***

*Drives per enclosure:*

Up to 4 drives total  
Up to 4 disk  
Up to 2 tape

*Mechanical*

Height: 5.25" (133mm)  
Width: 19.00" (483mm)  
Depth: 25.00" (635mm)  
Weight: 88 lbs. (40 kg) max.  
(maximum weight with four disk drives)

*Power Input*

Voltage: Standard . . . 90 to 135 Vac  
220 V Option 180 to 270 Vac  
Frequency: 47 to 63 Hz  
Current: 20 Amp maximum peak current at power up  
Fuse: 6.25 Amp Slo-Blo for 120 Vac units  
3 Amp Slo-Blo for 220-240 Vac units

*Available Power  
Output per Drive*

+5 Vdc @ 3.0 Amps  
+12 Vdc @ 3.5 Amps continuous  
+12 Vdc @ 4.5 Amps max at power-up  
50 watts maximum continuous  
Regulation: 2.0% maximum on +5V  
3.0% maximum on +12V

*Environmental*

*Operating Environment:*

Temperature: 0 to 45°C

*Non-Operating Environment:*

Temperature: -20 to +85°C

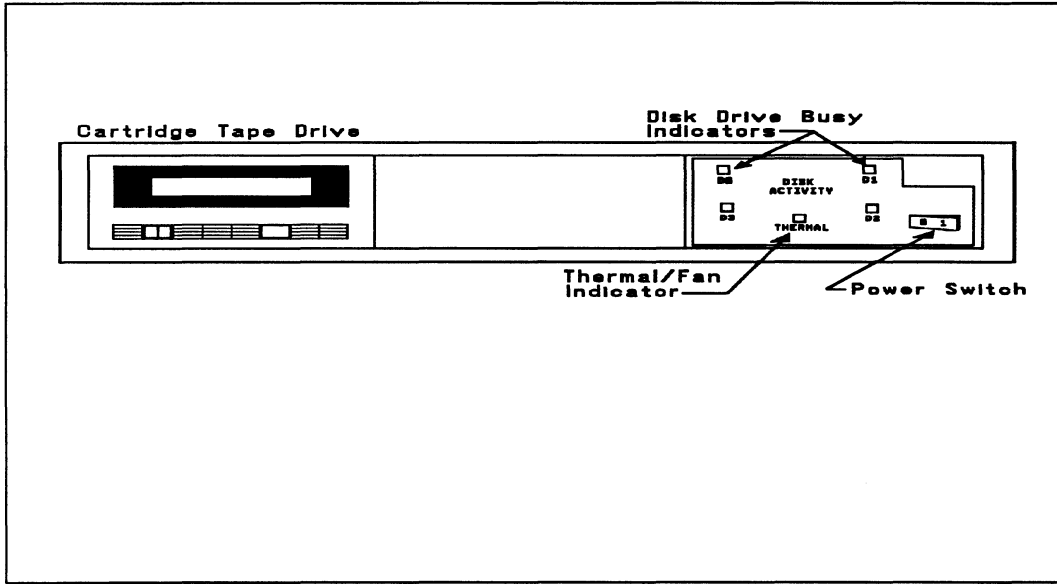

**Figure 1.2a**  
*Peripheral Enclosure Controls and Indicators*

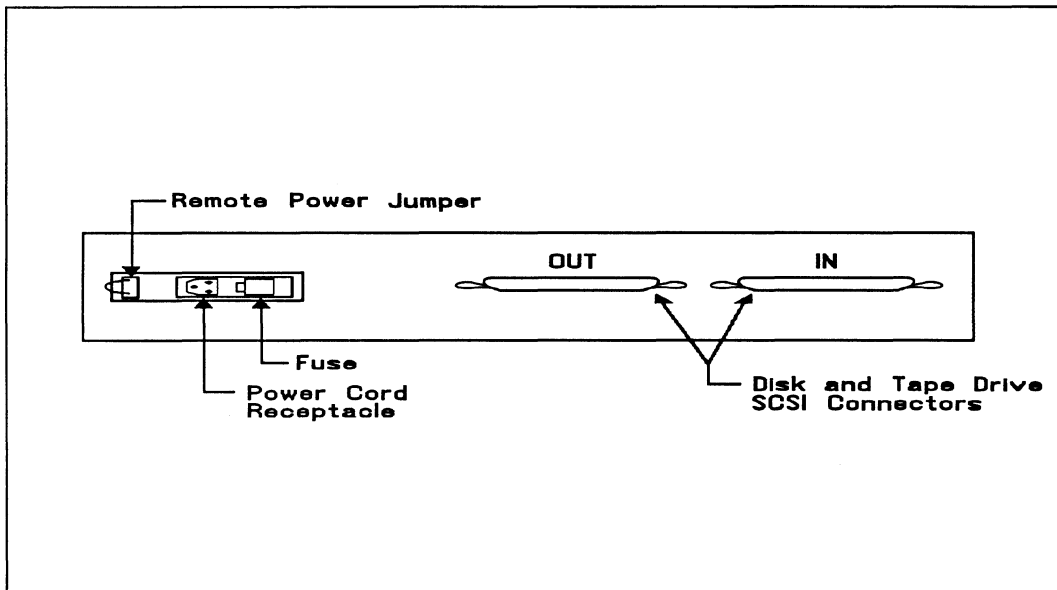

**Figure 1.2b**  
*Single Bus Peripheral Enclosure Rear View*

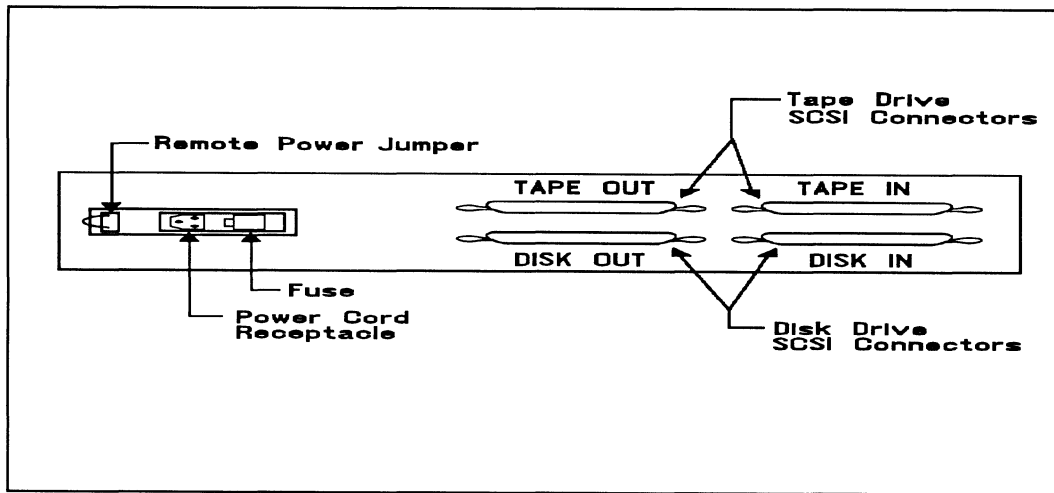

**Figure 1.2c**  
*Dual Bus Peripheral Enclosure Rear View*

### ***1.3 Peripheral Specifications***

Refer to Appendix A for individual disk and tape drive specifications including jumper and switch instructions.

### ***1.4 Regulatory & Safety Agency Standards***

The SKM subsystem is certified to the following standards:

#### **REGULATORY AGENCY:**

- FCC Rules, Part 15, Subpart J, Class A Computing Devices.

#### **SAFETY AGENCY:**

- The peripheral enclosure is UL and CSA recognized.

## 1.5 Cabling

### *Internal Cabling*

Internal cables connect from paddleboard to bulkhead. Located within the computer bulkhead panel are:

Paddleboard: Active backplane paddleboard with one 50-pin connector

Cable: 28" 50-conductor flat ribbon cable

### *External Cabling*

To connect from the computer bulkhead to the drive enclosure a shielded external cable is used. Daisy chain cables are also available to connect additional enclosures. The last enclosure must have a proper SCSI bus termination plug installed in the unused connector.

Standard External Cables:

Bulkhead-to-Drive: Nine-foot, 50-conductor, shielded round cable connecting bulkhead to disk/tape drive enclosure

Drive-to-Drive: Two-foot, 50-conductor, shielded round cable (optional) for connecting more enclosures

***NOTE The SCSI maximum cumulative cable length allowable for a fully populated subsystem is 82 feet for drives with differential interface and 19 feet for drives which use the single-ended interface.***

---

## Installation

### *2.0 Before You Begin Installation*

*The installation process can be divided into two parts: hardware and software. Hardware installation is covered first in the following sections. Every attempt has been made to cover the process sequentially. It would be a good idea to read through all the information before installing any hardware or software, and to have the suggested tools and references on hand.*

### *Overview of the Installation Process*

The installation process described in the following sections is designed to proceed step by step and provide methods for you to verify results. After you have all hardware in place, the checklist and power-up sequence provides a partial confirmation of success.

In the software section, using the Support Package Tape programs and other optional system tests, you can further determine your success.

### *Diagram of Installation Process*

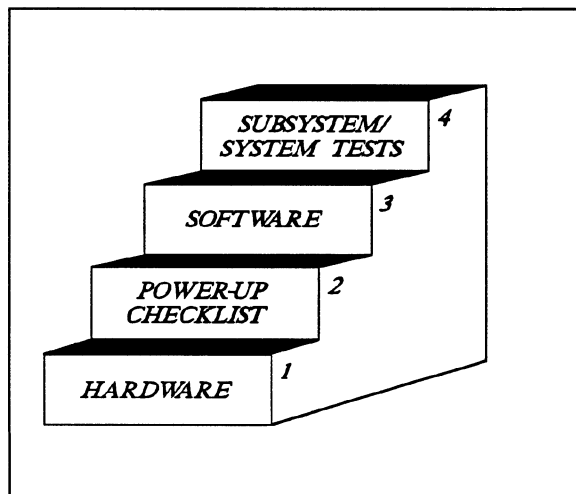



## **2.1 Hardware Installation Procedure**

*The hardware covered in this section includes the computer chassis, the disk and tape controller(s), disk and tape drive enclosures, and the cables. Any changes you may need to make to the hardware are described in the appropriate section.*

---

Each of the following sections details one of these steps for installation of the SKM subsystem:

1. Selecting slots for the controllers in the computer chassis and making the slots functional.
2. What to do with the jumpers and switches on the controllers.
3. Installing the controllers and paddleboards into the chassis.
4. Installing the peripheral enclosures.
5. Connecting all cables; SCSI and BMC.

Since so much of the installation depends on complying with Data General architecture, have reference material about the system hardware on hand. For example, in order to access the backplane to install the paddleboard, it will be necessary to remove the backpanel bulkhead (if FCC compliant). It may not be clear how to do this by just looking at it.

There are a variety of ways Data General sets up its computers.

- Some have vertically mounted boards, some are horizontal.
- Some have one IOC, others have more.
- Bus repeaters may be installed on an expansion chassis.

The scope of these installation instructions is broad. You must have enough information about the system itself to fill in the details. **Tools you may need for installation:**

1. A Phillips screwdriver
2. A set of nut drivers
3. A small straight-blade screwdriver
4. A large straight-blade screwdriver
5. A set of needlenose pliers
6. An adjustable open-ended wrench
7. A flashlight

**The controller is a sensitive piece of electronic equipment. Observe precautions to prevent damage by static; wear a wrist band and strap while handling the controller.**



*What to do if  
there is damage...*

Immediately after receiving it and before you unpack your Zetaco shipment, inspect the shipping carton(s) for any evidence of damage or mishandling in transit.

Zetaco's warranty does not cover shipping damages. Therefore, if the shipping cartons are water stained or otherwise damaged, contact the carrier or shipping agent, before opening, with information on the damage. Request that a representative be present during receiving inspection.

For repair or replacement of any Zetaco product damaged in shipment, call Zetaco for return instructions and authorization.

## ***2.11 Selecting a Slot & Making it Functional***

*The first thing to do is determine which slots of the computer can be used for the controllers. You will need to choose either one or two slots, depending on whether you are installing a single disk/tape controller or separate, dedicated disk and tape controllers. After choosing the slot(s) you must make sure the priority signals are available for the slots.*

---

### ***Single vs. Dual Controller Installation***

The SKM subsystem is available in single or dual controller configurations. That is, either dedicated controller circuit boards for disk and tape control (SCZ-3, SCZ-4), or a single combination disk/tape controller (SCZ-5). In addition, subsystems are also available in disk- or tape-only configurations, in which case only a single controller will be installed. If the SKM subsystem you are installing at this time will provide both disk and tape capabilities, you will install either one or two controller boards depending on which configuration you have. The following instructions will help guide you through installation of both single and dual controller approaches.

### ***Slot Selected Must be I/O ONLY***

The controllers must be installed in **I/O ONLY** slots. Each type of Data General computer reserves different slots as **I/O ONLY**. Refer to Table 2.11 for this specific information. Examine the computer to determine which of the proper slots are available. It may be necessary to rearrange boards to provide **I/O ONLY** slots for the controllers.

***CAUTION Component damage will result and Zetaco's warranty is VOID if anything other than an I/O ONLY slot is used.***

**Table 2.11****Identification of I/O ONLY Slots**

CPU Model I/O ONLY Slot Numbers

---

MV/4000 . . . .	12 - 20
MV/6000 . . . .	2 - 16 (I/O Expansion Chassis)
MV/7800* . . .	Chassis dependent
MV/8000 . . . .	29, 42, 48 - 56
MV/8000II . . .	9 - 21
MV/8000C . . .	13 - 20
MV/9500* . . .	Chassis dependent
MV/10000 . . .	13 - 24, 26 - 36
MV/15000 . . .	6 - 12
MV/20000 . . .	19 - 38
MV/40000** . .	Any Eclipse I/O Slot

---

\* Since the MV/7800 and the MV/9500 are upgrade vehicles for Data General machines, they can be installed in a variety of chassis types. Choose a slot defined as I/O ONLY for the type of chassis being used.

\*\* Only differential subsystems are supported on MV/40000 computers.

***Availability  
to BMC***

Since the BMC is the high-speed data path on the MV class machines, an increasing number of devices need access to it. The SKM subsystem controllers can only operate on the BMC. When planning slot location for the controller, availability of a BMC connector to that slot is as important as finding one that is I/O ONLY.

*More On Slot  
Selection*

The slot positions that you select to install the SKM disk and tape controllers will determine their Interrupt Priority. Generally, the closer a controller is to the CPU board within the computer chassis, the higher its interrupt priority is. It is beyond the scope of these instructions to recommend controller slot selection with regards to relationships with other controllers within the chassis. It should be noted however, that the SKM subsystem controllers are designed to be as independent as possible from interrupt priority level and to allow as much flexibility as possible in slot selection. If you are installing separate disk and tape controllers, try to choose two adjacent slots for the controllers to keep the installation simple; if you require the controllers to be in non-adjacent slots, any arrangement is acceptable as long as the slots are I/O ONLY and are within reach of the BMC bus cables.

### *Priority Must be Maintained*

There are two signals on the Data General backplane that aid the system in managing controller activity. These are: Data Channel (DCH) Priority, and Interrupt Priority. Even though the SKM subsystem controllers do not operate on the DCH bus, the DCH Priority signal must be available to pass to the next controller. If any empty slots exist between the CPU board and the controller furthest from it, it will be necessary to add jumper wires from the two Priority In signals of the lower empty slot to the two Priority out signals of the upper empty slot. Figure 2.11 demonstrates this.

### *Pin-to-Pin Connections*

Pin # A94 (*DCH IN*) of lower empty slot goes to Pin # A93 (*DCH OUT*) of upper empty slot

Pin # A96 (*INTERRUPT IN*) of lower empty slot goes to Pin # A95 (*INTERRUPT OUT*) of upper empty slot

The result of improper jumpering will be a non-functional system.

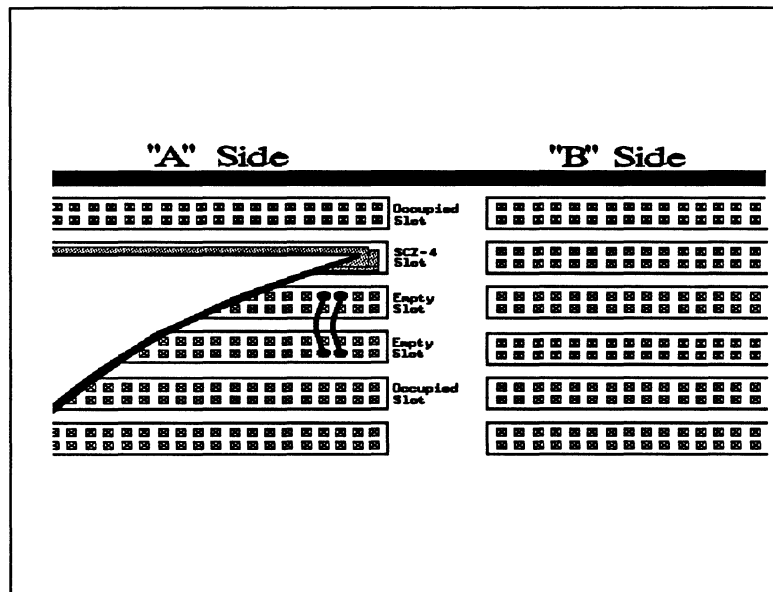

**Figure 2.11**  
*Backplane Priority Jumpers*

## ***2.12 Setting Controller Switches***

*Most option setup for the controllers are handled by programming E<sup>2</sup>PROMs on the controllers. The controller options handled in hardware are configured via the switchpack on the front of the board. Also, each paddleboard has one jumper that determines the source of SCSI terminator power.*

---

### ***Information Regarding Device Code Addresses***

The meaning of the device code switches on the front edge of the controllers varies depending on the controller model. On SCZ-3 disk and SCZ-4 tape controllers, the device code switch setting determines the actual DPJ or MTJ device code of the controller. This is the address by which the controller will be known to the operating system. The SCZ-5 disk/tape controller is different; its device code switches determine the controller "Maintenance Port", or MPORT address. This is a unique device code that utilities such as the Configurator use. Actual disk and tape device codes for the SCZ-5 controller are stored in E<sup>2</sup>PROM and are changable using the Configurator program, described later in this section.

### ***Setting the Device Code Address Switch on SCZ-5 Controllers***

On SCZ-5 controllers, switches 3-8 of the switchpack located on the front edge of the controller determine the maintenance port (MPORT) device code of the controller. It is this address through which the Configurator Program will later communicate with the SCZ-5, allowing you to set the controller's disk and tape device codes. Any device code not already selected may be used, but the standard ones are:

Primary. . . .40<sub>8</sub>  
Secondary. . . .41<sub>8</sub>

See Figure 2.12 for instructions on setting the SCZ-5 switches to select the MPORT device code.

## Setting the Device Code Address Switch on SCZ-3 and SCZ-4 Controllers

On SCZ-3 and SCZ-4 controllers, switches 3-8 of the switchpack located on the front edge of the controller determine the actual DPJ or MTJ device code by which the operating system will communicate with the controller. This address must be used in the VSGEN process discussed in Section 2.37. The standard device codes for the controllers are as follows:

For the SCZ-3 disk controller:

DPJ primary. . . . . 24<sub>8</sub>  
secondary. . . . . 64<sub>8</sub>

For the SCZ-4 tape controller:

MTJ primary. . . . . 23<sub>8</sub>  
secondary. . . . . 63<sub>8</sub>

See Figure 2.12 for instructions on setting the SCZ-3 and SCZ-4 switches to select the proper device codes.

**Note:**

- Switch Down = Binary 1
- Switch Up = Binary 0
- Switch 3 = Most Significant Bit
- Device Code = 40<sub>8</sub> is Shown
- Switch 2 = E<sup>2</sup>PROM Write Disable (DOWN)

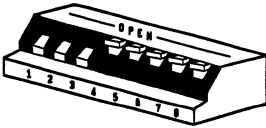

Device Code	S1 Over-ride	S2 E <sup>2</sup> PROM WRITE DISABLE	S3 DS0	S4 DS1	S5 DS2	S6 DS3	S7 DS4	S8 DS5
0X			UP	UP	UP			
1X			UP	UP	DOWN			
2X			UP	DOWN	UP			
3X			UP	DOWN	DOWN			
4X			DOWN	UP	UP			
5X			DOWN	UP	DOWN			
6X			DOWN	DOWN	UP			
7X			DOWN	DOWN	DOWN			
X0						UP	UP	UP
X1						UP	UP	DOWN
X2						UP	DOWN	UP
X3						UP	DOWN	DOWN
X4						DOWN	UP	UP
X5						DOWN	UP	DOWN
X6						DOWN	DOWN	UP
X7						DOWN	DOWN	DOWN

**Figure 2.12**  
Device Code Switches Located on Controller



*When to Use the  
E<sup>2</sup>PROM Write  
Disable*

The E<sup>2</sup>PROM on each controller stores information necessary for proper subsystem functioning. To completely protect this data against power transients, the option to disable writes to the E<sup>2</sup>PROM is available. In future installation steps some of this information may need to be modified to tailor a subsystem to the system into which it's being installed. At this time, leave switch 2 in the DOWN position to disable *writes*, until you run the Configuration Program.

*Using  
Configuration  
Over-ride (SCZ-4  
and SCZ-5 only)*

Think of this feature as 'insurance' — it disables all devices but the tape drive so that you can configure the controller without accidentally affecting the other peripherals. If you're booting the software support tape using the SCZ-4 or -5, you must boot from Logical Unit 0. This over-ride switch can be used to make sure the controller will recognize Logical Unit 0, enabling you to boot the Configurator Program.

The leftmost switch on the switchpack (S1) is the configuration override switch. When used, it forces controller options to the following known values.

For the SCZ-4 controller:

- Tape Logical Unit 0 is mapped to SCSI ID 0. Your tape boot device must be set to SCSI ID 0 to use this feature.

For the SCZ-5 controller:

- Tape device code is forced to the value set by the device code switchpack.
- Tape Logical Unit 0 is mapped to SCSI ID 5. Your tape boot device must be set to SCSI ID 5 to use this feature.
- The disk controller portion of the SCZ-5 becomes disabled until S1 is set back to the down position.

To use the Configuration Over-ride switch:

1. Set the controller device code switches to the tape controller device code.
2. Power-up the system.
3. Wait 30 seconds for the controller self-test to complete, as indicated when the LEDs are no longer lit.
4. Flip S1 UP.
5. After running the Configurator Program, flip S1 DOWN. If the controller is an SCZ-5, set S3-S8 back to the MPORT device code.

**If you have this switch UP before power-up or during self-test, the controller will loop on self-test.**

### **2.13 Jumpers**

Jumper W1-1 on the paddleboard is used to connect the controller's terminator power source to the SCSI bus. With jumper W1-1 installed, the controller will supply terminator power and maintain proper bus termination even if other terminator power sources, such as the second initiator in a dual-initiator configuration, or a peripheral are shut off. **Zetaco recommends that you leave Jumper W1-1 installed.** The paddleboard has an integral isolation diode that eliminates contention between multiple power sources.

## 2.14 Installing Controllers and Paddleboards

### How to Properly Install a Controller into its Slot

*For each controller installed you must also install a paddleboard on the computer "A" backplane at the same slot location as the controller. The physical placement of the controllers and paddleboards into the computer requires care and patience. You may find a flashlight to be helpful.*

1. See Figure 2.14. Pull out the levers at the front corners of the controller until they stick out straight in front.
2. Carefully guide the controller into the chosen I/O ONLY slot until the levers snap around the front of the chassis frame.
3. Gently apply pressure to the levers, thus forcing the goldfingers of the controller into the backplane socket. DO NOT apply undue pressure. If you don't feel the controller "give" a little as you are pushing it in, you may have the board misaligned. Remove and try again.
4. The board is properly installed if the levers end up flat against the board.

If you are inserting the controller into the middle of a group of boards, you may need to extend the adjacent boards to be even with the controller and insert them as a group.

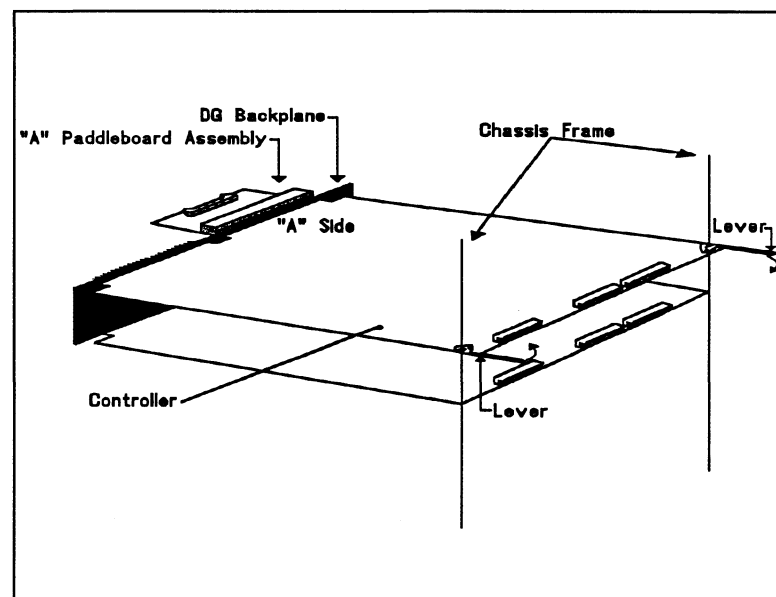

**Figure 2.14**  
*Installing the Paddleboard and Controller*

*How to Properly  
Install a  
Paddleboard*

If you are installing more than one controller, each controller requires one paddleboard. The same paddleboard type is used on all Zetaco controllers.

1. Determine the "A" side of the backplane. Viewed from the rear, the "A" side is on the left for a chassis with horizontal boards or on the top for a vertical board chassis. See Figure 2.14.
2. Locate the two rows of pins on the "A" side that correspond to the slot in which the controller is installed.
3. Check for and carefully straighten any bent pins. Use a different slot if any of the pins are broken off.
4. Position the paddleboard connector block to cover all 100 pins of the "A" backplane. **Be sure that the component side of the paddleboard is facing the same way as the components on the controller.**
5. Press the connector squarely over the pins, making sure all pins insert and do not bend, until the connector block is flush with the backplane. Although an amount of pressure is necessary, **DO NOT FORCE**.

**CAUTION** Component damage may occur at power-up if paddleboard is misaligned.

1. *Check BOTH ends for non-inserted pins.*
2. *Doublecheck that the block is positioned over the correct two rows of pins, and NOT between slots.*
3. *It may be necessary to count pairs of rows to determine correct positioning.*

## **2.15 Peripheral Enclosure Installation**

*The disk and tape drives of the SKM subsystem are mounted in a rack-mountable enclosure. Installing the enclosure consists of mounting the slide assemblies onto the vertical rails of the equipment rack, then inserting the enclosure into the slides.*

---

- 1. Determine the slide and L-bracket orientation.** There are two slide assemblies; one for the left side of the enclosure and one for the right. They are different and must be installed on the correct sides. When positioned correctly in the rack, the front slide release lever will be on the top side of each slide. See Figure 2.15. One end of each slide has four mounting holes in it. This end of the slide goes towards the rear of the equipment rack. An L-bracket mounts to the rear of each slide and provides a means of adjusting the slides to fit different rack types. Figure 2.15 shows the installation of L-brackets and slides for a typical rack with 20-21 inches between front and rear vertical rails. You may need to change the L-bracket orientation to fit your specific equipment rack.
- 2. Determine vertical positioning.** The front of each slide has two slots through which screws secure the slide to the front rail. When choosing the vertical position for mounting the slides, the following clearance should be maintained:
  - 1) Allow approximately 1" distance from the lower mounting slot on the front of the rail to the top of the peripheral or rack cover directly below it.
  - 2) Allow approximately 5 1/4" clearance for the enclosure height within the equipment rack.
- 3. Mount the L-brackets to the rear rails of the equipment rack.** First, fasten two 10-32 clip nuts onto each rail with the nut on the rear side. Next, secure each L-bracket to its rail with two 10-32 philips screws.
- 4. Mount the slide assemblies to the front rails.** Fasten two 10-32 clip nuts onto each front vertical rail with the nut on the rear side. Secure each slide to the rail with two 10-32 philips screws.

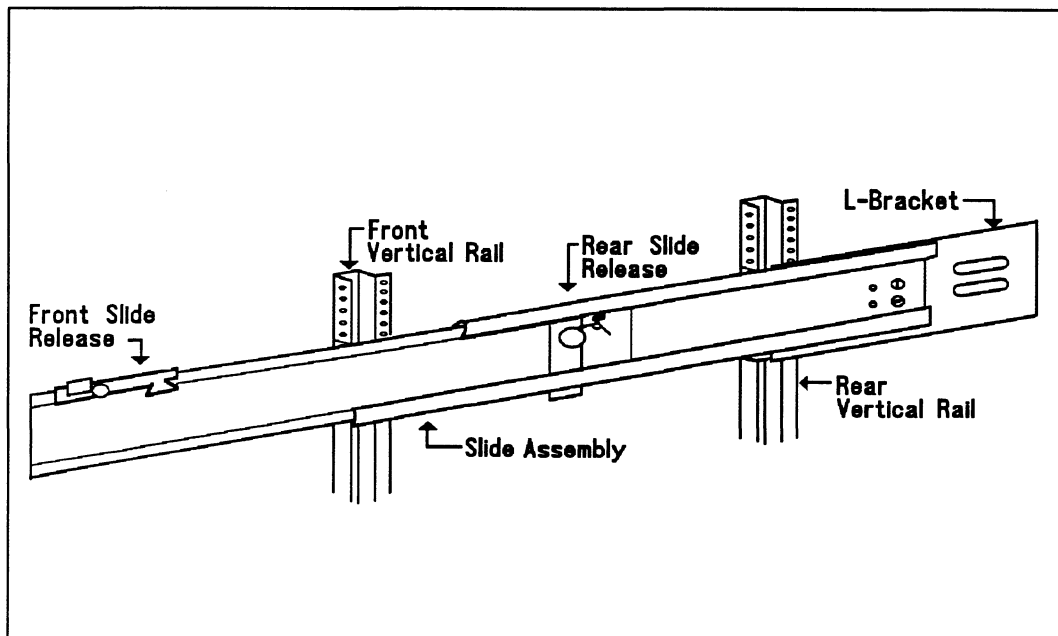

**Figure 2.15**  
*Enclosure Slide Assembly*

5. **Secure each L-bracket to its slide** using two 10-32 slotted screws and two 10-32 hex nuts.
6. **Install the enclosure onto the slides.** First, extend each slide out fully by pulling the inner member of each slide out until the rear slide release locks the slide in the extended position, as shown in Figure 2.15. Next, lift the enclosure and guide the slide members attached to the enclosure into the extended slides; this may require two people. Once guided into the slides, the enclosure will lock when it encounters the front slide release. Unlock the release by pressing down on the release lever. The rear release levers should automatically unlock as you push the enclosure in. To complete the enclosure installation, push the enclosure fully into the equipment rack.

***Connecting  
Power to the  
Enclosure***

Connect the receptacle end of the AC power cord to the receptacle on the rear of the enclosure. Insert the other end of the cord to a power source of the appropriate voltage for your system. Standard SKM subsystems require 110V AC. Optional 220V AC subsystems are also available. The power source should be of high quality and dedicated to your computer system. Some facilities may require power conditioning to ensure proper tolerances and filtering are maintained. Do not use the same circuit shared with miscellaneous equipment such as copiers, air conditioners, etc.

## 2.16 Connecting the Subsystem Cabling

For each controller, the cabling connecting out to the peripheral enclosure comes in two parts: internal and external. The separation occurs at the chassis bulkhead to comply with FCC regulations. Extra external cables are needed to cable to more than one enclosure. The BMC bus cables and BMC terminator attach to the controller front edge.

### Installing the Internal Cables

Each controller installed requires an internal cable. Each internal cable is a flat ribbon cable which plugs into the controller paddleboard at one end and mounts to the chassis bulkhead at the other end. Connect each internal cable as follows:

1. First, select one mounting hole on the bulkhead for each internal cable to be installed. Mark the bulkhead layout diagram for the chassis accordingly, indicating the function of each connector to be mounted to the bulkhead. This is especially important for two-controller subsystems, since the internal cables are identical for disk and tape.

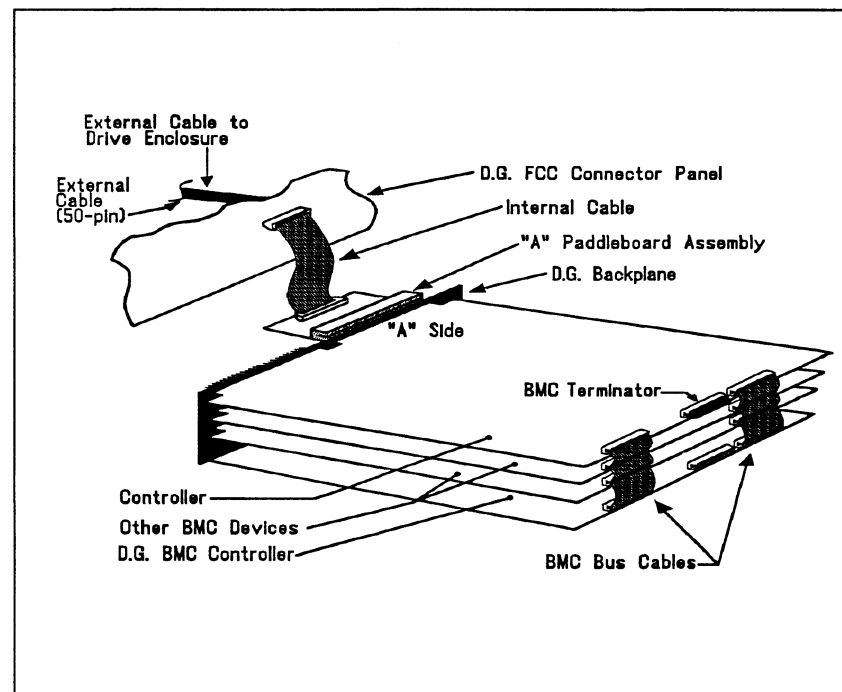

**Figure 2.16a**  
Controller Cabling Diagram



2. Remove the cover from the mounting hole on the bulkhead and remove the bolts, washers and nuts from the D-connector end of the internal cable.
3. Insert the connector into the mounting hole from the inside and fasten with the bolts from the outside.
4. Plug the other end of the internal cable into the appropriate paddleboard installed on the backplane. Be sure the arrow on the cable connector is on the right side (or toward the center of the chassis) as you plug it into the paddleboard.

### *Attaching the External Cables*

The external cables connect between the computer bulkhead and the peripheral enclosure containing the disk and tape drives. Figures 2.16b and 2.16c illustrate the external cabling for single (SCZ-5) and dedicated (SCZ-3/4) controller configurations, respectively. Each external cable has a "D" connector on one end which connects to the internal cables at the computer bulkhead, and a connector at the other end which plugs into the peripheral enclosure. Install the cables as follows:

For SCZ-5 controller configurations:

- Refer to Figure 2.16b. Connect the "D" connector of the external cable to the internal cable at the computer bulkhead and secure with the two screws on the sides of the connector. Connect the other end of the cable to one of the connectors on the rear of the peripheral enclosure and pull the retaining clips over the cable connector.

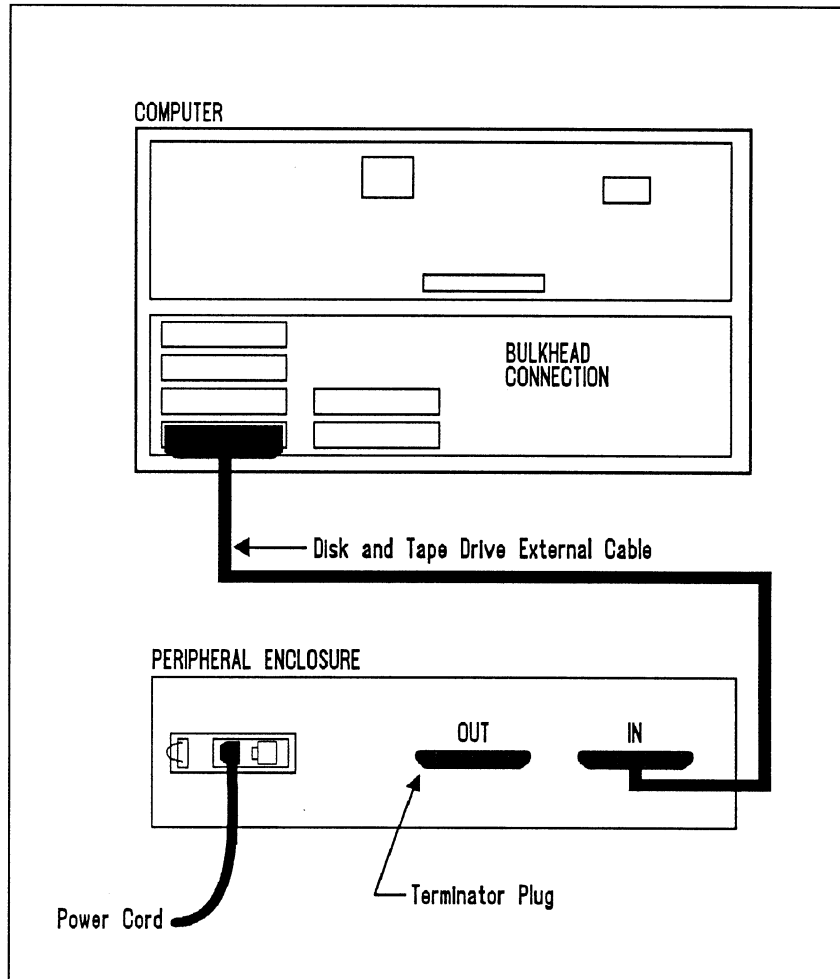

**Figure 2.16b**  
*Single Bus Peripheral Enclosure Cabling*

For dedicated (SCZ-3, SCZ-4) controller configurations:

- Refer to Figure 2.16c. Connect the "D" connector of one external cable to the internal cable on the bulkhead which connects to the SCZ-4 tape controller. This is the tape drive cable. Secure with the two screws on the sides of the connector. Connect the other end of the cable to the connector labeled "TAPE IN" on the rear of the peripheral enclosure and pull the retaining clips over the cable connector. Next, connect the disk drive external cable from the internal cable which connects to the SCZ-3 disk controller to the connector labeled "DISK IN" on the peripheral enclosure.

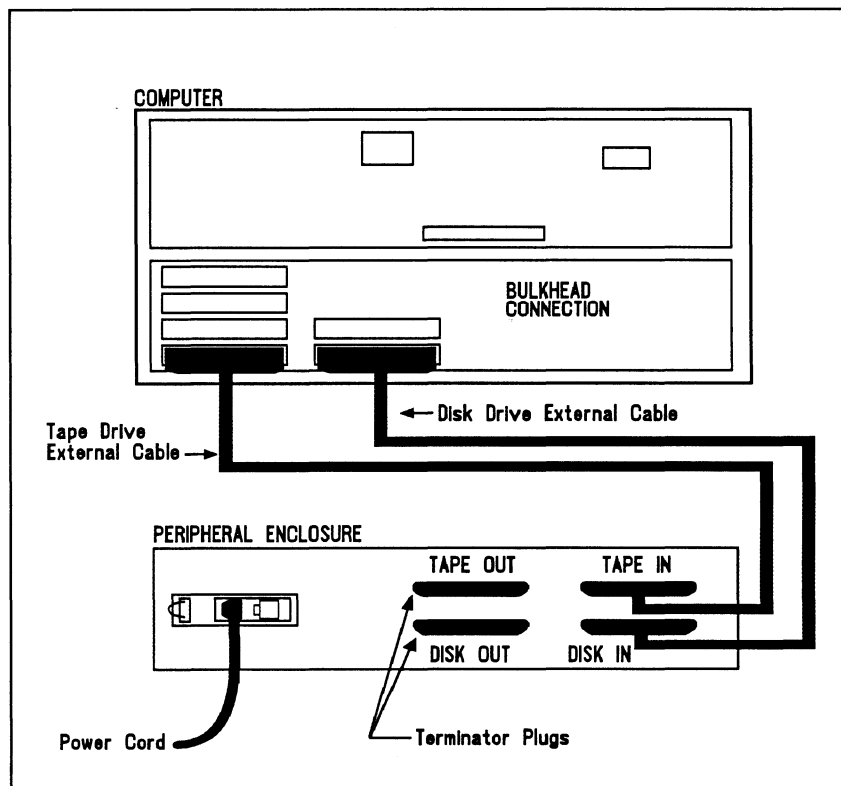

**Figure 2.16c**  
*Dual Bus Peripheral Enclosure Cabling*

---

### *Attach the SCSI Terminator Plugs*

Finally, attach the SCSI terminator plugs to the unused connectors on the rear of the peripheral enclosure. For dedicated controller configurations, connect terminator plugs to both the "DISK OUT" and "TAPE OUT" connectors. These terminators **MUST** be installed for the SCSI bus to function properly.

### *Installing the BMC Cables*

Since the BMC is the high-speed data path on the MV generation of computers, an increasing number of devices require access to it. Chances are that BMC cables are already in place on the system. If so, insert the free connectors of each cable into each controller being installed.

If there are no existing cables or if the existing cables do not have the required spare connectors, use the cables provided with your SKM subsystem. The BMC cables are the two 40 conductor ribbon cables with multiple connectors on each.

To install the provided BMC cables, see Figure 2.16a and install them as follows:

1. The end of the cables with a single connector goes to the system BMC controller. Pay attention to Pin 1 orientation as you insert.
2. The other end of each BMC bus cable will have connectors designed to be inserted into multiple BMC devices. Insert one connector from each cable into the sockets provided on the SKM subsystem controllers and also into all other BMC devices which require connection to the BMC bus.

The standard Zetaco BMC bus cables have 4 connectors to access BMC devices; cables with 6 and 8 connectors are also available.

### *Providing Termination for the BMC Bus*

The center connector on the front edge of each controller is the BMC terminator socket. Figure 2.16a shows the location. The last controller board on the BMC bus (the one furthest from the BMC controller) **MUST** be terminated and must be the **ONLY** controller terminated. Remove the terminator plug on all controllers except the last. One BMC terminator plug is shipped with each SKM subsystem.

## ***2.2 How to Check for Normal Power- Up***

*Before going on to the software part of the installation, you must make sure the hardware is working properly. The best way to test for initial problems is to turn on the power.*

---

The controllers go through a power-up self-test, as do the disk and tape drives. Other system devices, including the CPU, do this too.

When the SKM subsystem is functional, you should see:

- All controller LEDs will be out after 30 seconds.
- On the 8mm tape drive both the green and amber LEDs should be off after about 1 minute. If a tape is in the drive, the green LED will then go on about 8 seconds later, signifying the drive has a tape loaded and is ready. The amber LED should be remain off.
- The disk activity LEDs on the front right side of the peripheral enclosure should be off.
- The THERMAL LED on the peripheral enclosure should be ON, indicating that the cooling fans are operating properly.

When an MV system is ready, you should:

- Have a system prompt on your CRT screen.
- Be able to enter commands at the keyboard and get system response.
- Be able to load system microcode to make the system functional.

As an installation aid, refer to the Checklist in Table 2.2. If your subsystem did not power-up correctly, look through the checklist for omissions, then go to the "Trouble-shooting" chapter of this manual. Be sure all of the controller's switches are set properly.

*Table 2.2**Hardware Installation Checklist*

Check here:	If:
	<p>Controller slots are I/O ONLY</p> <p>Controllers have DCH and INT Priority to them</p> <p>DCH and INT Priority jumpered across empty slots</p> <p>Device Code switches are set properly</p> <p>Controllers inserted correctly (levers flush)</p> <p>Paddleboards are installed on "A" Side</p> <p>Paddleboards cover all 100 pins</p> <p>Paddleboards aligned to correct slots</p> <p>Controllers, Paddleboards are cabled to correct drives</p> <p>BMC cables installed to correct devices</p> <p>BMC terminator installed on last BMC device</p> <p>BMC terminators removed from all other BMC devices</p>

### ***2.3 The Software Installation Procedure***

*The software focused on here is the software necessary to complete the integration of the SKM subsystem into your system. You will need to configure the Controllers, initialize the disk(s), run tests, and enable the drivers under the operating system.*

---

The majority of the information in this chapter is about the programs written by Zetaco specifically for our products. The Data General system program, VSGEN must also be run. The Data General programs, CONTEST, MV/SYSTEMX, MLTT RELI and UDKV RELI are also tools for your use. Details on how to use these programs are not available here, only information on when their use is appropriate.

The following sections may be followed step-by-step in the order presented.

1. Using the Support Package Tapes.
2. Using the Configurator programs to set options.
3. Using the Initializer program for disk set-up.
4. Using the Reliability programs for test.
5. Preparation under the Operating System.

### ***Have Enough Reference Material Ready***

It is always appropriate to have Data General documentation on hand when installing something new. It would be especially valuable to have the Data General guide:

*"How to Generate and Run AOS/VS."*

The chapter on using VSGEN will be especially useful when performing the last step listed above.

If you have access to documentation on the Data General test programs available with the system, have that on hand also.

*System  
Requirements for  
Installation*

- An MV family CPU running AOS/VS with minimum 32K words of memory with MTJ and DPJ drivers available.
- Console at Device 10/11.
- Printer at Device 17 (if error log and configuration fact copies are desired).



### ***2.31 Using the Support Package Tape***

*There are several important tools supplied on the Support Package Tape. With the Configurator programs you may alter information stored in the E<sup>2</sup>PROMs on the controllers according to your needs. The Initializer program is used to format disks. The Reliability programs automatically perform a series of tests on the peripheral devices.*

---

#### ***What the Files on the Tapes are For***

The Support Package Tape is structured so that the programs on files two to five can be loaded and executed directly from the tape. These programs are used in the installation and maintenance of the controller and peripherals. Each is a stand-alone program; none can be run under the operating system.

File Six on the tape contains the following:

1. Copies of the Configurator, Disk Initializer, Tape Reliability, and Disk Reliability programs, in .SV file format. These programs can be booted from the system disk instead of the tape. However, it does not mean that they can run under AOS/VS, only that they are bootable from disk. Booting the programs from disk eliminates the need to mount the tape each time you need to run one of these programs. Once the programs have been loaded onto your disk, they may be executed using the "Run A Specified Program" function in your technical maintenance menu. Complete instructions are provided later in this section.
2. Stand-alone Disk Initializer program "SCZ5I.CLI". This macro calls a version of the Disk Initializer program which runs under the AOS/VS operating system. It is useful for performing the disk initialization functions without having to bring down the AOS/VS system. Complete instructions are provided later in this section for using the program.

Files 0 and 1 on each Support Package tape contain special bootstrap programs that perform housekeeping tasks so that other programs can run. They also bring up the tape menu seen in Figure 2.31.

#### ***SysAdmin Tools Added to Support Tape***

Along with .SV format copies of the other programs and a stand-alone Disk Initializer program, **File Six** on the SCZ-5 Software Support Package Tape includes (a) a handy diagnostic tool that displays the current status of all peripherals on the SCSI bus, 9b)

a program to automatically rewind and unload a specified tape, and (c) a program to format a tape in a dual density tape drive. To accommodate these three programs, there are nine files, three of which are the programs themselves, while the other six are *help* and *cli* files used to run the programs. The files are:

SCZ5M.PR	SCZ-5 Monitor program
SCZ5M.CLI	Used to run SCZ5M.PR
SCZ5M.HELP	This file contains a copy of the help information from SCZ5M.PR
REWUL.PR	SCZ-5 Rewind Unload program
REWUL.CLI	Used to run REWUL.PR
REWUL.HELP	This file contains a copy of the help information from REWUL.PR
SCZ5TF.PR	SCZ-5 TAPE Format program
SCZ5TF.CLI	Used to run SCZ5TF.PR
SCZ5TF.HELP	This file contains a copy of the help information from SCZ5TF.PR

### *How to Access the Tapes*

All devices on the SCZ-5 SCSI bus and the computer should be powered on the ready, with no error conditions. The next step is to access the contents of the Support Package Tape.

The Support Package software has been shipped to you on a standard 9-track, 1/2" reel. If you have installed a 1/2" reel tape drive for use with your SCZ-5, you may boot the tape from this drive, assuming the SCZ-5 has been pre-configured to known settings (device code, tape drive model). The standard SCZ-5 tape device code is 23<sub>8</sub>. Or, you can boot the software tape from any other 1/2" 1600 BPI tape subsystem you may already have installed on your system. Do the following:

1. Mount the tape on your 1/2" reel tape drive. Make sure you know the device code for which the 1/2" tape controller is set.
2. Load the system microcode if you are just powering the system up. (System microcode is not necessary to run the Configurator program, but it is necessary for the Reliability programs and Initializer.)
3. When the SCP prompt appears, type B or BOOT and the device code of the tape controller being used:

SCP> BOOT nn <or> B nn, where "nn" is the device code of your 1/2" tape controller.

After a time, the Support Tape menu is displayed, as shown in Figure 2.31.

<u>File</u>	<u>#Program</u>
2	SCZ-5 Configurator
3	SCZ-5 Disk Initializer
4	SCZ-5 Tape Reliability
5	SCZ-5 Disk Reliability
6	Standamong Disk Initializer SCZ5I
	Standamong SCZ-5 monitor SCZ5M
	Standamong SCZ-5 rewind unload REWUL
	Standamong SCZ-5 tape formatter SCZ5TF and previous ".SV" files in AOS/VS Dump format.

**Figure 2.35**  
**Support Tape Menu**

4. Enter the file number (2-5) of the program you want to run, followed by a carriage return. The selected program will be loaded into CPU memory and executed.

### **2.32 Using the Configurator Programs to Set Options**

*The performance of the SKM controllers and the peripherals it controls depends on more than how fast the drives are.... it also relies on how well the other pieces of the system interact together. The Configurator programs provide a dialogue, giving you choices on controller set-up, to allow you to easily change what is already stored. General instructions are provided here on using the Configurator programs. More detailed instructions may be found in the "help" functions of the programs themselves.*

---

The Configurator programs allow you to change various controller setup parameters that are stored on the controller in non-volatile memory. The programs are designed to interact with you, helping you decide what to do if you need help. Although your controller may have been preset to recommended factory settings, it is suggested that you review the current controller settings, checking to see that those settings are correct for your system, and familiarize yourself with the Configurator program and the various controller options.

The Configurator is an easy-to-use program. After you boot the program and provide the controller device code, the program reads the current controller settings and displays an overview of those settings. Examine the data in the overview. It is important to make sure that the Burst Rate, Break Count, and BMC Priority values are what you want. Also verify that the correct peripheral units are specified.

After you are done making your changes to the configuration, be sure to "Update" the controller. To do this, set the E<sup>2</sup>PROM write-disable switch (S2) to the UP, or write-enabled position. Next, enter the appropriate key to perform the "update" function. **When the update is complete, flip S2 DOWN to protect the E<sup>2</sup>PROM contents.**

### ***2.33 More Information on Which Options to Change***

*Anytime you add to a system, you change the interaction of the parts. The transition can be painless by choosing the set-up options intelligently. This section describes some of the options that are common to the various SKM subsystem controller models.*

---

#### ***BMC Options***

How you select the values for these options will affect how well the new controllers interact with those already there. Base your decisions for these values on:

1. How much system-wide traffic the Controller will be asked to handle.
2. When the Subsystem will get the most use. After or before hours? During peak worktime?

**BMC PRIORITY:** Use extreme care in selecting this value. You must assign the controller a priority value between 0 and 7 that is **NOT CURRENTLY USED** by any other BMC devices in the system. (On the MV/4000 you must choose between 0 and 3.) Each controller that uses the BMC bus must be assigned a unique priority value. There must be no duplication. The higher the number given to a device, the more priority or "weight" the Data General BMC controller gives to its request for bus access.

**RECOMMENDATION:** Choose the highest values possible without conflicting with those values already assigned to BMC devices within your system. If you are installing separate disk and tape controllers, assign the disk the higher number of the two. Combination disk/tape controllers (SCZ-5) are assigned a single BMC priority value for both disk and tape.

**BMC BURST RATE:** This value can be 2, 4, 8, 16, 32, 64, 128, or 256. This is the number of words that will be transferred by the controller per BMC bus request. After the transfer limit has been reached, the controller must relinquish the bus and wait to try again. A low value may make data transfers take a long time, decreasing performance. A high value may dominate the bus, causing data late problems with other controllers. On SCZ-5 controllers, you can choose separate and different parameters for disk and tape.

**RECOMMENDATION:** Of course it depends on your system usage, but a good number to begin with is 32 for both disk and tape.

**BMC BREAK COUNT:** Choose a number between 1 and 255. This sets the amount of time the controller waits between data transfers, before trying to get access to the BMC bus again. Basically, this number tells the controller how many BMC Sync Clock periods it must count before making another BMC request. On SCZ-5 controllers, you can choose separate and different parameters for disk and tape.

Try to balance this number with the BMC priority selected. A high priority device with a small Break Count will be on the bus a greater amount of time, possibly excluding others.

**RECOMMENDATION:** A good number to begin with is 4.

<b><u>BMC OPTION:</u></b>	<b><u>WHAT TO REMEMBER:</u></b>	<b><u>RECOMMENDATION:</u></b>
Priority	- Want highest numbers assigned to the most intensively used devices. - DO NOT DUPLICATE	Highest Number Possible
Burst Rate	- Low value on high traffic device could cause lowered performance. - High value can cause device to dominate BMC bus causing data late on others.	32
Break Count	- Balance this number with priority of the device. - Too high a value may degrade drive-to-controller performance.	4

**DISK BYTE ORDER:** This parameter determines in which order the two bytes of a word of data from memory are transferred between the controller and disk drive. "Least Significant Byte First" means that the controller will send the lower 8 bits of each word to/from the disk drive first and the upper 8 bits of the word last. "Most Significant" will transfer the upper 8 bits first followed by the lower 8 bits. This feature is offered as a means of obtaining compatibility with other systems in a multiple-host system configuration. Tape byte order is not affected and is always Most Significant Byte First.

**RECOMMENDATION:** Set this parameter to the "Least Significant Byte First", then modify as necessary later. Note that if you're replacing a Zetaco SCZ-3 Disk Controller with an SCZ-5, set the byte order to match the one being replaced.

### *Selecting SCSI ID for the Controller*

A SCSI ID is a unique value in the range 0 to 7 assigned to each device connected to a SCSI bus. The controller is counted as one of the eight possible devices, and it is through the Configurator program that you choose the ID value to assign it. The ID numbers are weighted, with more priority going to the higher number device when two or more devices are bidding for control of the SCSI bus at the same time.

**A SCSI ID of 7 is recommended for each controller. Be sure that there are no duplicate ID's on a single bus. If you are installing separate disk and tape controllers, you can set each to a SCSI ID of 7 since they use separate SCSI busses to communicate with the disk and tape devices.**

### ***2.34 Using the Disk Initializer Program***

*The Disk Initializer is used to prepare disk drives for use with the subsystem. If you received the disk drives and controller together as a subsystem, the drives may have already been prepared for you; however, an understanding of this program is recommended for anyone who deals with the installation or maintenance of the equipment.*

---

***WARNING:*** *Use of this program may result in loss of all data on the disk drives. Please read the following sections carefully. If you choose to perform a format or write/read analyze, all data on the specified disk drive will be destroyed.*

The Disk Initializer is used to format, perform a surface analysis on, and help manage media flaws (also known as "bad blocks") on the disk drives. In addition, on SCZ-3 disk controllers, the Initializer program is used to install the controller microcode onto the disk drive.

Most disk drive models have some degree of built-in bad block management of their own, which helps offload the effort required of the controller (and system maintenance personnel) in handling bad blocks. For a more detailed description of what *format* and *analyze* will do, refer to the section on Choosing Program Options.

#### ***Running Stand-alone Disk Initializer***

To run the stand-alone Disk Initializer Program, either load the program from tape per the instructions in section 2.31, or from disk, per the instructions in section 2.37.

#### ***Running Stand-among Disk Initializer (SCZ-5 Only)***

For the SCZ-5 controller only, a stand-among version of the Disk Initializer program is also available. This version runs under AOS/VS or AOS/VS II and is useful for performing various tasks without the need to bring the system down, such as formatting optical platters to prepare the platters for use. In addition, this program replaces the "Read Soft Error Log" utility used with SCZ-3 controllers, which allows you to examine the controller soft error log. This program will not, however, allow you to format or analyze a disk that is currently INIT'd under the system. To perform those functions you must either RELEASE the disk unit or use the stand-alone Disk Initializer program.



To run the SCZ-5 stand-alone Disk Initializer, you must first have loaded the program from tape onto disk per the instructions in section 2.37. You can then run it from any user console enabled by EXEC. To run the program, you must have both the SUPERUSER and CHANGE TYPE privileges assigned to your username by the Profile Editor. Refer to the Generating and Running AOS/VS documentation for more information on user profiles.

When the SCZ5I.CLI macro is invoked, the environment is pushed, then the current directory is changed to :UTIL and SCZ5I.PR is executed. Upon program termination, the previous environment and directory are restored.

With the :UTIL directory in your searchlist, type

```
) SUPERUSER ON <cr>  
*) SCZ5I <cr>
```

The program will begin execution. The program will ask you for the controller Maintenance Port device code. This is the device code that the controller front switches are set to. DO NOT enter the controller disk device code. The program will then determine the disk device code and confirm it before proceeding. One difference between the stand-alone and stand-alone versions is the stand-alone version requires that you enter each unit by its disk unit name, or "DPJxx". Also, stand-alone SCZ5I restricts operations performed on disks currently INIT'd under the system. To perform those functions that access the user data area of the disk such as Format, Analyze or Relocate Blocks, you must first RELEASE the disk unit.

### *When to Use This Program*

Use the Disk Initializer when you want to:

1. Completely re-initialize a disk drive for use with the system. The disk may be new and possibly unformatted, or you may simply want to perform a total re-initialization of the disk drive to ensure its format is good.
2. Examine and/or relocate the bad blocks in the controller soft error log.

3. Perform other scheduled system maintenance, which may include one or more of the following operations.  
"Destructive" indicates that the operation will result in a loss of data on that disk.
  - Install controller microcode onto disk (SCZ-3 disk controller only)
  - Relocate the bad blocks in the controller soft error log
  - Relocate other bad blocks not found in the soft error log
  - Perform a *read-only* analysis of the entire disk
  - Perform a *write/read/verify* analysis of the entire disk (**destructive**)
  - Perform a format of the entire disk (**destructive**)

*The Program  
Sequence to  
Follow*

Basically, when you run the program, you:

1. Choose the disk drive units and the program options for each unit. Use the [E] command from the main menu. In response to "Device Code?", enter the device code of the disk controller.
2. Start the operations. Use the [S] command from the main menu.
3. To monitor program status, use the [L] command.

## ***Choosing Disk Initializer Options for Each Unit***

### ***Analyze Disk***

This option performs a disk surface analysis to detect and then relocate the bad blocks to another area of the disk. The purpose of analyze is to detect and remove as many bad blocks as possible before using the disk under the system, reducing the risk of loss of data later if a defect worsens. This selection can also be used as a disk initialization do-all since it allows you to perform all the options on the specified unit.

First, the program asks whether you wish to format the disk prior to it performing the surface analysis. Refer to the Format option description for more information on formatting the disk and on the following question of whether or not to retain previously relocated sectors.

Next, the program asks whether or not you wish to run Read-Only Analyze.

- Read-Only Analyze performs a non-destructive, one-pass, sequential *read* over the entire disk to test for bad blocks. When the program finds a bad block, it relocates the block along with the data contained in it to a good "spare" block in a reserved area of the disk. The result of using this option is that it will eliminate as many "soft" errors as possible without losing or affecting any disk data. This option will also offer you the choice of whether or not to relocate the blocks listed in the controller soft error log. We recommend you answer **NO** to this question if your disk drive is configured with Auto-relocation **ENABLED**, or **YES** if the disk drive is configured with Auto-relocation **DISABLED**. Refer to the Relocate Blocks option for more information on auto-relocation.

If you answer **NO** to the Read-Only Analyze question, the program will perform a full *write/read/verify* data analysis. This choice is recommended for any new installation before the disk is put into use with the operation system. If you choose this option, we also recommend you answered **YES** to "Format?" earlier to allow new sector headers to be written onto the disk.

- Write/Read/Verify Analyze performs a multiple-pattern sequential *write/read* data verification over the entire disk to detect and relocate as many bad blocks as possible. **USE OF**

---

**THIS OPTION WILL RESULT IN THE LOSS OF ALL DISK DATA FOR THE SPECIFIED UNIT.**

The program asks how many data patterns you wish to use to detect data-sensitive and intermittent media defects. Enter a number between 1 and 10. The more data patterns used, the longer the testing will take. We recommend at least 3 patterns be used. If the controller soft error log contains any blocks, the program will ask if you want the blocks relocated. Again, we recommend you answer **NO** to this question if your disk drive is configured with Auto-relocation **ENABLED**, or **YES** if the disk drive is configured with Auto-relocation **DISABLED**.

### *Relocate Blocks*

This option allows you to examine and/or relocate the blocks listed in the controller soft error log and/or any additional bad block addresses you wish to enter yourself. The soft error log is a log, maintained by the controller, of the addresses of disk blocks that the disk drive has reported as having "soft errors". By relocating blocks, disk data is moved to good blocks on the disk, reducing the risk of losing data should the original soft error worsen. If the auto-relocation feature for a disk unit is enabled, then the log represents disk blocks that have **ALREADY BEEN RELOCATED BY THE DISK DRIVE**. If auto-relocation is disabled, the log represents disk blocks that have **NOT BEEN RELOCATED BY THE DISK DRIVE**.

A basic rule of thumb is as follows:

- 1) If you run with Auto-Relocation **ENABLED**, do **NOT** relocate the blocks listed in the soft error log, as the disk drive has already done this for you. You may want to get a hard copy of these block addresses for future reference.
- 2) If you run with Auto-Relocation **DISABLED**, you may want to relocate these blocks using this option as a periodic maintenance step.

For those block addresses you wish to enter manually, you must enter in the disk physical block address format. If you wish to relocate a block listed in your system log that is in cylinder/head/sector format, you must convert it to the physical block address using this formula:

$$\begin{aligned} &(\# \text{ of heads/drive} * \# \text{ of sectors/track} * \text{cylinder} \#) \\ &+ (\# \text{ of sectors/track} * \text{head} \#) \\ &+ (\text{sector} \#) \end{aligned}$$

---

= physical block address

which reduces to:

$$\begin{aligned} &(20 * 128 * \text{cylinder} \#) \\ &+ (128 * \text{head} \#) \\ &+ (\text{sector} \#) \end{aligned}$$

---

= physical block address

NOTE: All disk types used with the disk controller are logically defined as having 20 heads and 128 sectors per track.

### *Microcode Install Only*

This option applies only to the SCZ-3 disk controller. It is used to install the controller host-microprocessor microcode onto a new disk drive or to install microcode updates. (SCSI-microprocessor microcode resides in EPROM memory on the controller, not on the disk drive.) Microcode is installed on the disk drive automatically when you choose the **ANALYZE** option. The controller requires that microcode be installed on logical disk unit 0. We recommend that microcode be installed on all other disk units as well.

### *Format Only*

The Format Only option is the lowest level operation you can give a disk drive and is the first step in a full disk initialization. Normally, you would not use this option but would instead perform the format by answering YES to the "Format?" question in the Analyze option path, since you should normally follow a re-format with a surface analysis. The format operation erases and re-records block addresses on the disk surfaces, ensuring readable block headers and track alignment. **USE OF THE FORMAT OPTION WILL RESULT IN THE LOSS OF ALL DATA ON THE SPECIFIED DISK DRIVE.**

The program asks if you want to "Retain Previously Relocated Sectors?" This refers to whether or not the disk drive retains its "growth" list of relocated blocks, i.e., those blocks that have been detected as bad over time by either the Disk Initializer program or the drive itself, and have been relocated. This does NOT refer to the drive's "primary" defect list written by the drive manufacturer — these relocated blocks are not affected.

We recommend that you answer YES to this question, unless some abnormal condition may have caused the disk drive to relocate an excessive amount of bad sectors that may not have been bad. If you answer NO, we recommend that you run at least a 5-pattern *write/read/verify* surface analysis on the drive.

### *INIT Soft Error Log*

This option clears the controller soft error log without relocating the blocks listed in it. It should normally only be used when the selected drive is configured with Auto-Relocation enabled, after the log has been examined and recorded. If Auto-Relocation is enabled, the log represents blocks that have already been relocated by the disk drive.

### *If You Are Upgrading an SCZ-3 to an SCZ-5 Controller*

If you are upgrading a subsystem, from an SCZ-3.1 or SCZ-3.2 controller to an SCZ-5 Controller, you do not need to run the Disk Initializer program. The disks need no re-initialization to upgrade to the SCZ-5 Controller. All controller microcode is contained in EPROM on the SCZ-5 controller, not on the disk drives. This applies to rewriteable optical disk subsystems as well.

### **2.35 Using SCZ5M Monitor Program**

*SCZ5M monitors all disk and tape activity on a SCZ-5 Multifunction Controller, reading this information from the controller's maintenance port. It can also be used to find out how much tape is still available for recording on a tape cartridge.*

---

SCZ5M.PR, which is the Monitor Program, can be especially helpful as a diagnostic tool because it displays the status of all devices on the SCSI bus, so you can see what's going on at any given time.

A copy of what the help information for this program looks like is shown below. Note that you can exit the Monitor Program at any time by typing (cntl C) then (cntl B).

### **SCZ-5 Monitor Help**

Description:

This program will display the current file number, record number, and active SCSI command for all configured tape units. It will also display the last block number accessed and active SCSI command for all configured disk units.

Requirements:

The SCZ-5 monitor program requires an SCZ-5 controller board. You also must have the CHANGE TYPE privilege to execute this program.

Switches:

These switches may be used in any combination or not at all.

`/MODE=` (0 for OCTAL, 1 for DECIMAL, and 2 for  
HEXADECIMAL) default = 1

This allows the numbers to be displayed in octal, decimal, or hexadecimal. octal numbers are displayed with no leading zeros and no leading zeros and followed by a decimal point. hexadecimal numbers are displayed with leading zeros but no point afterwards.

`/MPORT=` (maintenance port device code in OCTAL)  
default = 40

This allows the device code of the SCZ-5 maintenance port (the switches on the front of the controller board) to be a nonstandard value.

**/UPDATE=** (0-65 seconds) default = 3 seconds

This allows the delay time between screen updates to be set. The shorter this time is, the faster changes will show up on the screen and the more CPU and controller time the program will consume.

**/TREM @MTJX**

This displays the amount of tape remaining on the specified drive. This information is read directly from the tape drive.

**/TTY**

Use this switch if you have a TTY or hard copy type terminal.

**/HELP** This displays this help information.

Exiting the program: Exit the SCZ-5 monitor at any time by typing (cntl C) then (cntl B).

*Status definitions:*

Idle	There was no SCSI command active when the SCZ-5 was polled
Read	Read disk sectors or read tape records
Write	Write disk sectors or write tape records
Format	Format a disk unit
Recal	Return the disk read/write heads to cylinder zero
SpaceF	Space file marks
SpaceR	Space records
Rewind	Rewind the tape unit to the beginning of the tape (BOT)
Rew UL	Rewind and unload a tape
Load	Load a tape
WFMK	Write a file mark
Erase	Erase tape
T Rdy	Test unit ready
Mo Sel	Mode select
Mo Sen	Mode sense
Rq Sns	Request sense data from the drive

**Example:** X SCZ5M/MPORT=41/MODE=0/UPDATE=0  
The maintenance port device code is 41 octal, numbers are printed in octal, and the creen is updated as fast as possible.



### ***2.36 Using the REWUL Rewind/Unload program***

*REWUL is used to rewind and unload a tape on the SCZ-5 Multifunction Controller, instead of the standard rewind command in AOS/VS or AOS/VS II.*

---

REWUL is especially useful if you wish to remove the tape from the drive after rewinding, or if the system administrator wishes to prohibit anyone else from using a tape after a backup. One way the latter could be done is to do the backup from a .CLI file and have the last command in the .CLI file be REWUL @MTJX where X is the tape unit number.

Example:

```
DUMP_II/V @MTJ0:0 :UDD:#  
DUMP_II/V @MTJ0:1 :UTIL:#  
REWUL @MTJ0
```

This is a copy of the help information for this program:

### ***SCZ-5 Rewind Unload Help***

Description:

This program will rewind and unload program requires an SCZ-5 controller board. You must have the CHANGE TYPE privilege to execute this program.

Switches:

/MPORT= (maintenance port device code in OCTAL)  
default = 40

This allows the device code of the SCZ-5 maintenance port (the switches on the front of the controller) to be a nonstandard value.

/HELP= Displays this help information.

**Example:** REWUL/MPORT=41 @MTJ0  
The maintenance port device code is 41 octal and @MTJ0 is rewound and unloaded.

## **2.27 Using the SCZ5TF Tape Formatter Program**

*SCZ5TF is used for formatting a tape in a dual density tape drive such as the WangDAT 2600*

SCZ5TF is used for initializing new tapes to the desired format, or for changing the format of an old tape. Most of the tape drives that require formatting default to the highest density format when a new blank tape is used.

If an old tape or a formatted tape is used, SCZ5TF determines the current format and uses it.

## **SCZ-5 Tape Format Help**

This is a copy of the help information for this program:

Description:

This program formats a tape to the specified tape density.

Requirements:

The SCZ-5 Tape Format program requires a SCZ-5 controller board. (You must have the CHANGE TYPE privilege to execute this program.)

Switches:

**/MPORT=** (maintenance port device code in OCTAL)  
default = 40

This allows the device code of the SCZ-5 maintenance port (the switches on the front of the controller board) to be a nonstandard value.

**/HELP** This displays this help information.

**/LOW** Use this to select the lowest density on multi-density drives:

4mm drives - standard DDS format.  
8mm drives - EXB-8200 format.

**/HIGH** Use this to select the highest density on multi-density drives:

4mm drives - data compression format.  
8mm drives - EXB-8500 format.

Example: SCZ5TF/MPORT=41/LOW @MTJ0

The maintenance port device code is 41 octal and the tape in @MTJ0 is formatted to the lowest density format.

Note that the tape format must be specified.

## 2.38 Using the Reliability Programs

*The function of the Reliability programs is exactly what the name implies: they test that the drive and controller are operational, and that extended use with the combinations of commands does not make them fail. There are separate test programs for disk and tape, but they operating in the same fashion.*

As a stand-alone program, each Reliability utility tests only the part of the subsystem that you are installing; disk or tape. No attempt is made to provide an exhaustive system level test. It does not, for example, tell you if you have duplicated BMC priorities. To test for system level functioning, run Data General's MVSYSYSTEMX.

```

RELIABILITY PROGRAM
Enable mapping (YES, {NO}):
Execution Mode:
  {R}andom Reliability      {S}equential Reliability
Enter your choice {R}:

          SCZ-n RELIABILITY UTILITY
          REV. XX
          COPYRIGHT 19XX, BBTACO, INC.

          COMMAND LIST

  {E}NTER A DEVICE          {D}ELETE A DEVICE
  {S}TART A DEVICE         {H}ALT A DEVICE
  {C}OMMAND LIST          {L}IST ERROR TOTALS
  {F}LAGS                  {M}ODE OF DISPLAY
  {Q}UIT

ENTER A COMMAND SELECTION (C=CMD LIST):

```

**Figure 2.36**

### *Main Menu of Reliability Test Program*

### *Choosing the Program Global Parameters*

Before you get to the Main Menu, you are asked to choose several global operating parameters. These choices are asked only when the program is booted or restarted. The parameters are for: **Mapping** and **Program Execution Modes**.

### **Mapping**

Enabling this feature allows the Reliability program to test some of the mapping features for which the controller is responsible. These features are defined in the Data General Programmer's Reference series. It is not necessary to enable mapping in order to test controller-drive functionality. The default answer is no. **DO NOT enable this mode if running in an MV/7800 or MV/4000.**

### ***Program Execution Modes***

You may choose to run in sequential or random mode for both disk and tape.

**Disk:** In sequential mode, the entire disk is written once. The controller re-reads it to verify, then stops. In random mode, the controller writes a random number of sectors at random locations, then reads it all back to verify. Random mode will continue until stopped. The time it takes to run these processes varies, depending on the size and speed of the disk drive.

**Tape:** In sequential mode, continuous *writes* of a fixed size are performed to EOT, the tape is rewound, and, if the verify feature is enabled, a *read* to EOT ensues. In random modes, a variable number of records containing a various number of bytes is written to a file. It is immediately read and verified (if enabled), and the program continues. Random mode will continue until stopped.

### ***The Program Sequence to Follow***

Basically, when you run the program, you:

1. Select the global program parameters. Random Mode with no mapping is a good choice for first installation. Let the test run for 20 minutes.
2. Enter the devices you want to test and the test specifics for each of them. Use the [E] command from the main menu.
3. Run the tests. Use the [S] command.
4. Examine the status of each drive. Use the [L] command.

See the section on Trouble-shooting for information on error messages from this program.

---

## 2.39 Summary of Reliability Commands

*Use this explanation of each Reliability command to better understand how to use the program. Commands are the same in both Reliability programs.*

---

### The Main Menu Options

1. **ENTER A DEVICE** – This command does several things:
  - a) Initializes the Controller.

b) Looks for READY units - You may operate on any drive that appears READY to the Controller. The program reports, starting with UNIT 0, that a drive is ready and allows a YES/NO choice for selection.

c) Sets Disk & Tape Test Parameters - After accepting a READY unit for testing, the program asks for input about the records the test will write.

**DISK:** The screen shows how many megabytes the disk has, then accepts YES/NO choices for *write* only, *read* only, to verify data, and one of nine data patterns to *write/read*.

**TAPE:** For random mode, the program will ask the maximum number of records it can put in each file, and the maximum number of bytes each record can contain. For sequential mode, it requests only the fixed number of bytes to put in each record. Default value is given for each question. Next, the program accepts YES/NO choices for *write* only, *read* only, verify data, and one of nine data patterns to *write/read*.

After each READY unit that you wish to run has its test parameters defined, the program returns to the command prompt. To actually begin the tests you have selected, use the START command.

2. **START A DEVICE** – This command gives you the option of starting the test on all entered devices, or on any combination of them. To verify that the program is running, observe the green LED's on the controller or issue a LIST command.

3. **LIST ERROR TOTALS** – This command lists status and error information. It can be used any time you wish to find out about the devices running. If you use the command before issuing a **START**, the disk information about mode will be accurate, but the runtime, blocks written and read, and error totals will not; and tape information about current file, current records, and EOTs reached will not be correct.
4. **COMMAND LIST** – This command displays the Command Menu.
5. **HALT A DEVICE** – Any device can be halted without affecting tests being performed on other devices.
6. **DELETE A DEVICE** – Once you **HALT** a test being run on a device, you can delete that device from the testing altogether, by using this command.
7. **PRINTER CONTROL** – This command enables or disables the printer. If the program is running unattended, enable the printer so you can capture error messages. Use of this command does not affect tests being run. A program **RESTART** will put it back to the default of disabled printer.
8. **RESTART THE PROGRAM** – This command completely re-initializes the program. You must reselect mode, devices, and re-enable the printer.
9. **FLAGS** – The flag available in the Reliability program can be set to halt the program when an error is encountered or, the default, simply log the error and continue. If you choose to halt at an error condition, the program will log the error and jump to the Debugger resident in the program. To leave the Debugger, and restart the program, type **RT**. The flag may be changed while tests are running.
10. **QUIT** – This command gets you out of the program.
11. **MODIFY DISPLAY MODE** – You can choose to use hexadecimal, decimal or octal for program display and input.

---

## ***2.40 Preparation Under the Operating System***

*Any controller and drive being added to a Data General system needs to be made recognizable to the system software. This is done using the VSGEN program provided with AOS/VS system software. Also, files from the Support Package Tape may be loaded onto an AOS/VS system disk for ease of future use.*

---

### ***Why Run VSGEN?***

All hardware in a system needs to be unified in some way in order to work together. This is the job of the system software, or Operating System. There are several layers of complexity to this software. That software closest to the hardware is often said to DRIVE the hardware. It knows about the bit meanings of status returned and how to tell the hardware what to do. This software is referred to as a DRIVER. All pieces of hardware need a Driver to interpret and translate for it.

The purpose of the program VSGEN is to select the Driver compatible with the hardware you are installing.

### ***What to Know Before You Run VSGEN***

You need to know:

1. What device codes to which you have set the disk and tape ports/controllers.
2. The drivers to select are MTJ for tape, and DPJ for disk.
3. The name of the configuration file to edit for additions.
4. The unit number for which each device is configured.

For further assistance, consult system management documentation.



*Loading Support  
Tape Files Onto  
an AOS/VS System  
Disk*

The last file on the Support Package tape is in DUMP format. This means that it is recognizable to the system LOAD command.

*Standard CLI  
Commands to  
Load the "DUMP"  
File*

**SCZ-3 AND SCZ-4 CONTROLLERS:**

First, "DIR" over to the directory you want the programs to reside. We suggest the UTIL directory as UTIL is a common directory usually included in the searchlist. Use the following script:

**SUPERUSER ON**

**DIR :UTIL** (or another directory you want the programs to reside)

**LOAD/V @MTzx:y**

**REW @MTzx**

**SUPERUSER OFF**

where:

z = the tape controller type (A, B, C, D, or J)

x = the tape unit number

y = the file number:

5 for the SCZ-3 tape

4 for the SCZ-4 tape

**SCZ-5 CONTROLLER:**

First, "DIR" to the root (: ) directory, then load the programs from tape using the following script. The programs will automatically be loaded into the :UTIL directory for you.

(NOTE: the stand-alone SCZ-5 Disk Initializer program and its macro MUST reside in :UTIL directory to function properly. Running the program in the same directory that LDUs reside may have adverse effects under the AOS/VS II operating system.)

**SUPERUSER ON**

**DIR :**

**LOAD/V @MTzx:6**

**REW @MTzx**

**SUPERUSER OFF**



where:

z = the tape controller type (A, B, C, D, or J)

x = the tape unit number

### *Running Stand-alone Programs*

To load and run a stand-alone program from disk, bring down your system and re-boot your disk. From your Technical Maintenance Menu, choose the option "Run A Specified Program". Enter the full pathname of the file you want to run, including the .SV extension.

When loaded into the UTIL directory of your system disk as described above, these are the file names to use:

#### SCZ-3 Controller Programs:

```
Configurator . . . . . :UTIL:CFSCZ3.SV
Disk Initializer . . . . :UTIL:SCZ3I.SV
Disk Reliability . . . . :UTIL:SCZ3R.SV
```

#### SCZ-4 Controller Programs:

```
Configurator . . . . . :UTIL:CFSCZ4.SV
Tape Reliability . . . . :UTIL:SCZ4R.SV
```

#### SCZ-5 Controller Programs:

```
Configurator . . . . . :UTIL:CFSCZ5.SV
Disk Initializer . . . . :UTIL:SCZ5I.SV
Tape Reliability . . . . :UTIL:SCZ5TR.SV
Disk Reliability . . . . :UTIL:SCZ5DR.SV
```

### *Running Stand-among Programs*

#### **SCZ-3 CONTROLLERS:**

To run the Standamong programs for the SCZ-3 controller, first make sure your searchlist includes the directory that the program is in. Enter "X" followed by the filename. For example, to run the Read Soft Error Log Installer, enter:

**X SCZORI**

The following are the standamong programs available for the SCZ-3 controller:

```
Stand-among Disk Read
  Soft Error Log Utility . . . .SCZOR.PR
Stand-among Disk Read
  Soft Error Log Installer . . .SCZORI.PR
```

**SCZ-5 CONTROLLERS:**

To run the SCZ-5 stand-alone Disk Initializer, first make sure your current searchlist contains the :UTIL directory. You must also have your Superuser privilege on. Enter:

**SUPERUSER ON <cr>**

**SCZ5I <cr>**

---

## Trouble-shooting

### *3.0 Trouble-shooting Subsystem Errors*

*Problems can occur during initial installation or after a period of time. Most installation difficulties are apparent at the first power-up or while performing installation set-up and test procedures using the Support Package Tape. Problems that occur after a time of successful usage are more likely to take the form of system error messages. Trouble-shooting under the operating system is difficult if not impossible. It is best to rely on stand alone test programs such as Zetaco Reliability or Data General MVSYSTEMX for help.*

#### *Power-up Problems*

You must be aware of equipment failure messages at the crucial time of applying power to the subsystem. In this matter, the hardware is supported by:

- Microprocessor based controller self-tests performed each time power is applied
- Controller LED status indicators for self-test
- Disk and tape drive self test at power-up
- Disk and tape drive LED status indicators for self-test

#### *Test Programs to Use*

The SKM subsystem has its own easy-to-use test programs, written specifically for it. They should be used during installation and may also be used at any time problems are suspected. Data General programs such as MVSYSTEMX, MLTT\_RELI, UDKV\_RELI and CONTEST may also be used on this Zetaco product and can be useful to diagnose unclear system errors.

#### *Field Support*

Zetaco provides support through authorized distributors with:

- Quick turnaround for factory repair/replacement
- Warranties on workmanship and materials

### ***3.1 Controller Faults Reported by LED Error Codes***

*In addition to showing operational status, the LEDs located on the front edge of the controller are also used to display error codes to help determine fault conditions. This section is intended to help identify a malfunctioning controller and recommend a possible course of action.*

---

Generally, during normal controller usage, the front edge green and yellow LEDs are used to indicate various controller activity as described in Appendix B. The red LEDs should not normally be on unless there is a controller fault condition. If any of the LEDs appear to remain steady on (hang), or flash a regular pattern, then a fault condition may be present.

#### ***Self-Test***

Controller self-test is designed to check the most critical functions of the hardware each time power is applied. Self-test is composed of two modules, each consisting of a series of tests performed by independent microprocessors. Associated with each module are a group of LEDs on the front edge of the controller.

Self-test takes up to 30 seconds to complete. During this time the two red LEDs should be on. On SCZ-3 and SCZ-4 controllers, the yellow LED in the left side group should also be on. Following self-test, all LEDs should go off. If the LEDs remain on or off, or flash an error code pattern, proceed with this section for help in identifying and correcting the problem.

*If Self-test Fails*

When power is applied to the controller, if the LEDs remain steady on, off or flash an error code pattern, refer to Table 3.1. The table lists various symptoms and what action can be taken for each. If the problem cannot be resolved, refer to the last section in this chapter for controller return instructions and other information.

*Error Codes Displayed During System Operation*

There is a group of error conditions that are displayed on the LEDs by the controller during normal usage, or run-time. These errors are displayed by the SCSI microprocessor and all have a "7" octal as the most significant digit. Refer to the following sections for instructions on decoding the SCSI side error codes and for a list of runtime errors. These errors will usually be accompanied by a system error if running under the operating system. The error code helps to provide further detail about the actual malfunction.

Table 3.1

*What the Controller LEDs Mean*

SYMPTOM	WHAT TO TRY
Both RED LEDs steadily lit.	Re-seat controller or install in another slot.
A pattern is flashed on the LEDs.	Retry power-up. Record error code. Call for assistance.
All LEDs extinguished.	<b>Don't do anything!</b> This is normal.

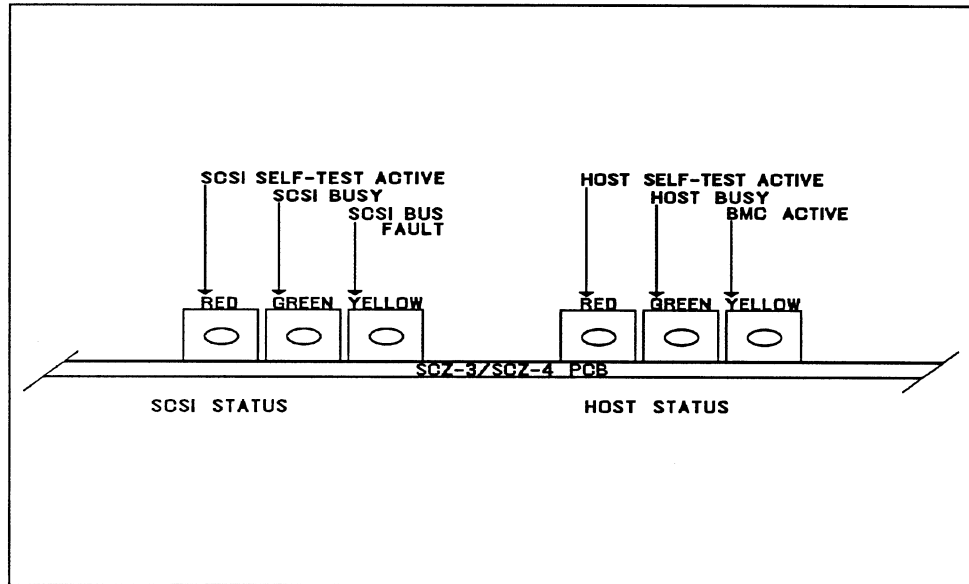

**Figure 3.1a**  
*SCZ-3 and SCZ-4 LED Status Indicators*

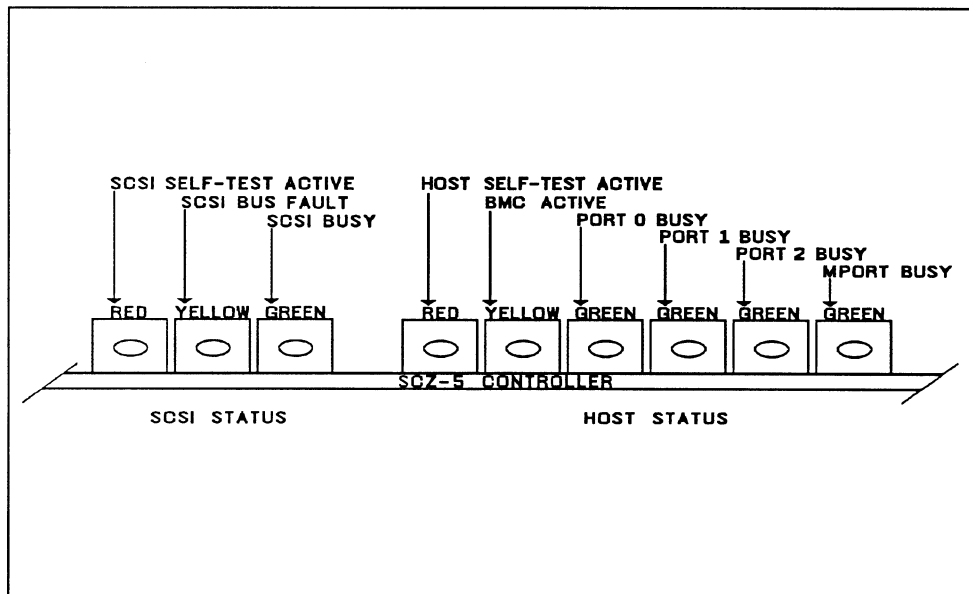

**Figure 3.1b**  
*SCZ-5 LED Status Indicators*



### ***3.11 Identifying the Self-test Failure***

*There are two sets of LEDs that reflect the status of the two parts of the board. The right-most group of LEDs report the status of the tests performed on the Host logic, which is responsive to the Data General Argus drivers. The left-most three LEDs correlate to the tests performed on the logic controlling the SCSI device(s). Each side has a different way to report a test that fails.*

---

#### ***Host Side Error Decoding***

When the Host side logic errors during self-test, the red LED on the right flashes. The number of times it flashes between pauses corresponds to the number of the test that failed. Refer to the following sections for a list of error codes and their meanings.

#### ***SCSI Side Error Decoding***

The numbering of the SCSI side tests is in octal. All three of the LEDs on the left are used to indicate the octal number of the test that failed, not just the red LED.

The octal number is displayed in binary format on the LEDs. Since the highest single digit in octal is seven, three LEDs are enough to transmit the code of the failing test, one digit at a time.

Figure 3.11 shows the octal values represented by the LEDs. Follow this procedure to decode them:

1. Watch for all three LEDs to light in sequence, right to left. This marks the beginning of the code sequence.
2. Observe which LEDs light next and record the value as the Most Significant Digit of the code, determined from Figure 3.11.
3. After a blank pause, observe which LEDs light next and record the value as the Least Significant Digit of the code, also determined from Figure 3.11.
4. After another blank pause, the beginning sequence will reoccur, and the code will repeat.
5. Refer to the following sections for SCSI side error codes and their meanings.

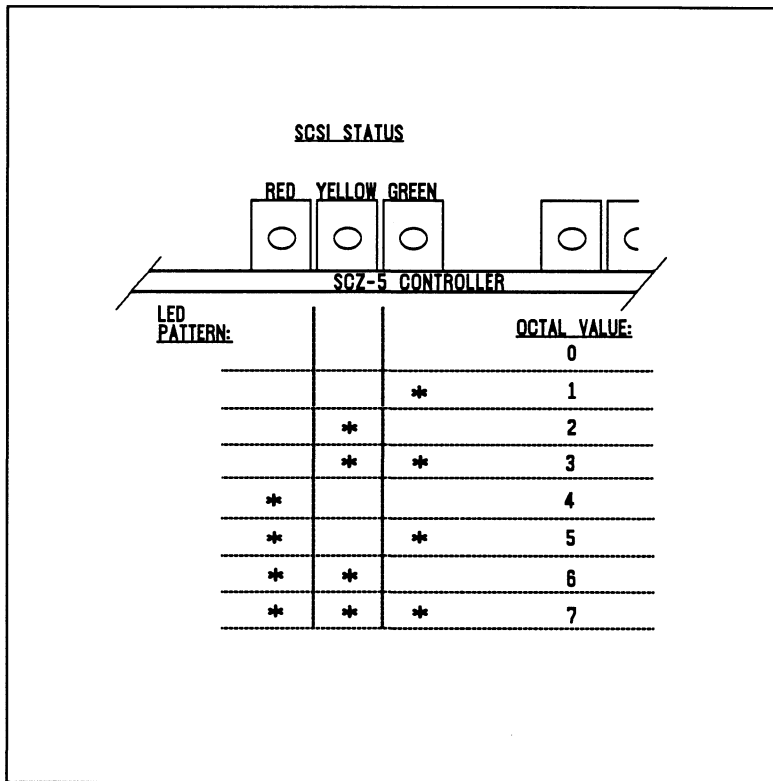

**Figure 3.11**  
Getting an Octal Number from LEDs

**3.12 Error Codes  
For SCZ-3 and  
SCZ-4  
Controllers**

The following are the error codes displayed by the SCZ-3 disk controller and the SCZ-4 tape controller.

*Host Side Errors  
(Right-Most  
LEDs)*

RED LED FLASHES:

TEST THAT FAILED:

1	General purpose RAM
2	High speed buffer bank 0
3	High speed buffer bank 1
4	Done flip-flop
5	BMC burst counter
6	BMC break counter
7	BMC CB test
8	Sector transfer simulation
9	E <sup>2</sup> PROM checksum
10	Dual-port RAM
11	Reserved
12	Reserved
13 and above	Decimal value of SCSI side failure

*SCSI Side Errors  
(Left-Most LEDs)*

ERROR CODE:

TEST THAT FAILED:

13	Error programming the gate array
14	Error reading back/verifying the programmable gate array
15	Static RAM test
16	BMC buffer test
17	BMC buffer parity error
20	DMA transfer counter
21	DMA address counter
22	80186 timer
23	SCSI control chip registers
24	SCSI hang timer test
25	Illegal 80186 interrupt

Runtime errors:

73	SCSI-to-host request queue overflow (SCZ-4)
74	SCSI CB-done queue overflow (SCZ-4)
75	SCSI CB queue overflow (SCZ4)
76	Illegal command/Illegal 186 interrupt
77	Memory fault

**3.13 Error Codes For the SCZ-5 Controller**

The following are the error codes displayed by the SCZ-5 combination disk/tape controller.

**Host Side Errors (Right-Most LEDs)**

RED LED FLASHES:

TEST THAT FAILED:

1	High speed buffer bank 0
2	High speed buffer bank 1
3	Dual-port RAM
4	Combined dual-port RAM
5	General purpose RAM
12	E <sup>2</sup> PROM Checksum ( <i>follow Reconfigure Instructions</i> )
13 and above	Decimal value of SCSI side failure

*SCSI Side Errors*  
(Left-Most LEDs)

<u>ERROR CODE:</u>	<u>TEST THAT FAILED:</u>
04	Combined dual-port RAM
15	Error programming the gate array
16	Error reading back/verifying the programmable gate array
17	Static RAM test
20	BMC buffer test
21	BMC buffer parity error
22	DMA transfer counter
23	DMA address counter
24	80186 timer
25	SCSI control chip registers
26	SCSI hang timer test
27	Illegal 80186 interrupt
Runtime errors:	
72	Illegal 80186 interrupt
73	SCSI-to-host request queue overflow
74	SCSI CB-done queue overflow
75	SCSI CB queue overflow
76	Illegal command
77	Memory fault

*Reconfigure  
Instructions  
(SCZ-5 Only)*

All configurable SCZ-5 options are held in an E<sup>2</sup>PROM, which stands for *Electrically Erasable Programmable Read Only Memory*. Since the chip can be erased electrically by design, it can be affected by transient pulses or by static. If the contents of the SCZ-5 E<sup>2</sup>PROM are corrupt, its checksum will be wrong when checked during self-test and self-test will fail with an "E<sup>2</sup>PROM Checksum" error. Do the following to remedy this:

1. Locate switchpack on front of SCZ-5 and flip switch 1 UP to stop the LED from flashing, thus allowing self-test to complete.
2. After the LED has stopped flashing, leave switch 1 UP until after configuration. Flip switch 2 UP to **enable writes** to the E<sup>2</sup>PROM.
3. Bring up the SCZ-5 Configurator program and re-input configuration facts. Update the E<sup>2</sup>PROM.
4. **Be sure to put switches 1 and 2 DOWN again.** It is a good idea to keep a print-out of the correct configuration facts.

### 3.2 Peripheral Enclosure Faults

*The following are some common problems associated with the peripheral enclosure and steps that may be taken to resolve them. If the problem cannot be resolved, call for assistance as described at the end of this chapter.*

---

**The peripheral enclosure THERMAL LED or the tape drive LEDs show no activity upon powerup.**

1. Ensure the AC power cord is firmly seated in the power receptacle on the enclosure.
2. Check the enclosure fuse. If replacement is necessary, use ONLY a 6 1/4 Amp Slo-Blo for 120 VAC or 3 Amp Slo-Blo for 220-240 VAC.
3. Ensure the AC wall receptacle is "live".

**A Thermal alarm occurs, indicated by a flashing RED THERMAL LED and an audible alarm. The alarm occurs if either the DC power to the fans drop voltage or if the fans drop RPM. Green indicates no thermal problem.**

1. Extend the enclosure from the chassis and verify the fans on the right side of the enclosure are operating. Retry power up. Call for assistance.

### ***3.3 8mm Tape Drive Faults***

*The 8mm tape drive goes through a self-test every time the enclosure power is turned on. If all tests do not pass, the two front panel LEDs will flash.*

---

#### ***Normal Power-Up Initialization***

To determine whether the power up of the drive is normal, look for the following to occur:

1. The amber and green LEDs are both on during the self-test diagnostics.
2. Both LEDs should be on for about one minute.
3. After self-test, both LEDs will turn off.
4. If a tape is in the drive, the drive will take about 8 seconds to position at Logical Beginning Of Tape (LBOT). You will be able to hear it working.
5. Once the tape is at LBOT, the green LED alone will go on to indicate READY status.
6. If no tape is in the drive, both LEDs will remain off until a tape is inserted.

The green LED on alone means the drive is loaded with a tape and is ready for a command. The amber LED flashing alone means there is activity on the SCSI bus. Both the green and amber LEDs flashing means self-test diagnostic has failed. See Table 3.

#### ***Self-Test That Does Not Complete***

If self-test finds a problem with one of the tape functions, the LEDs will flash. If both LEDs stay on for more than a minute, self-test is not completing properly. This could be because the controller paddleboard is connected to the wrong slot or misaligned on the controller slot. Check the controller to enclosure cabling path, cables and paddleboards.



**Table 3.3*****Definition of Tape Drive LEDs***

<b>LED Activity</b>	<b>What It Means</b>	<b>What To Do</b>
Both ON steadily	Self-test running	NORMAL; 1 minute. If longer, check paddleboard location.
Both OFF	Self-test OK, no tape	NORMAL; load a tape
Both FLASHING	Self-test FAILED	1. Retry power-on 2. Call for assistance
GREEN only ON	Drive READY, tape LOADED	NORMAL; continue using
AMBER only FLASHING	Drive is working	NORMAL; continue using

### **3.4 Disk Drive Faults**

*To accurately diagnose a faulty disk drive, you should run the disk reliability program as described in Section 2. The following are some symptoms and checks that can be made before and during the reliability test.*

---

#### **Disk activity indicator on enclosure never comes on.**

1. Ensure the enclosure is receiving AC power as described in Section 3.2.
2. Make sure the controller paddleboard is connected to the same slot as the controller and that it is not misaligned.
3. Check controller to enclosure cabling.

**Disk drive does not appear to spin up.** This may be difficult to observe. You may need to extend the enclosure on its slides and listen closely on the top cover. With the controller and all other peripherals or enclosures connected to the controller powered up, listen for the disks to spin up when you apply power to the enclosure. If you do not hear the disk spin up, check the following:

1. Verify that the controller and all other peripherals included in the SKM subsystem are receiving proper power. Some peripherals adversely affect the SCSI bus if connected to it but not powered up, which can in turn affect other peripherals.
2. Verify power is available to the enclosure by checking that the GREEN THERMAL LED is ON.
3. Check the paddleboard installation for the wrong or misaligned slot. Check all other cabling from controller to enclosure.

### ***3.5 Problems Running the Utility Programs***

*Sometimes difficulty running the utility programs is due to operator or installation error. Sometimes it is defective equipment. There are a few things to check on first that might lead to a simple solution to a problem.*

---

It is valuable to use the Zetaco Utility Programs, Configurator, Initializer, and Reliability programs anytime you suspect trouble with the SKM Subsystem. During initial installation, they are most valuable in assessing any trouble before running under the operating system.

If you are having trouble getting the programs to run properly, there may be defective equipment, or just operator or installation error.

#### ***Assumptions About the Installation***

The following information is based on the assumption that these things are true:

1. The controller is installed in a good slot.
2. The backplane and BMC priorities are correct.
3. No problems exist with the computer, your disk or tape drive, or other peripherals.

If you cannot verify these assumptions for the system you are working on, start your investigation there.

#### ***Two Common Difficulties When Running the Programs***

To eliminate operator or installation error from consideration when these errors occur, try the following suggestions.

1. *Controller does not respond when selected*

This can happen with any of the programs, but for various reasons. Most often you will see a *hang* condition after you enter the device code of the board when the program prompts for it. It is at this point that the program tries to communicate with the controller. Anything in the path of communication between board and program is suspect. This includes backplane priority and connection, device code settings, and system microcode corruption.

*2. Drives appear not ready*

You will only see this with the Initializer or Reliability programs because the Configurator only needs to communicate to the board. You don't even need to hook up the drives to run the Configurator.

The Reliability program goes through an Initialization process when the [E]nter Device command is used. Part of this process is to try to access any drive for which it is configured and report back on its READY status. If a drive is not READY, the program cannot use it, and will not allow you to select it. Anything in the path of communication between the controller and drive is suspect. This includes cables, paddleboard, position of paddleboard, drive facts in Configurator, and SCSI drive ID settings. Whether the drive is powered down or improperly terminated could be a factor.

The same concerns and checks would be appropriate if it is the WRONG drive that appears ready.

**Table 3.5**

***Common Problems & Solutions Using Utility Programs***

IF THIS:	YOU'LL SEE THIS:	CHECK/TRY THIS:
Controller does not respond	Configurator will hang Reliability will error	1) Device code as used & as configured 2) Load/Reload system microcode 3) Re-seat controller & retry 4) Has controller self-test passed?
Drive(s) appear Not Ready	Reliability will report Not Ready Configurator doesn't care	1) Verify configuration facts 2) Replace cables to drive 3) Paddleboard installed at correct slot 4) Replace paddleboard 5) SCSI Drive ID switches are correct 6) Drive is turned on 7) Correct drive/enclosure is terminated
Wrong drive appears Ready	Reliability reports wrong drive Ready Configurator doesn't care	1) Verify configuration facts 2) SCSI Drive ID switches are correct 3) Termination is on correct drive/enclosure 4) ALL drives are turned on

### 3.6 Types of Error Messages From Reliability

*Run a Reliability program anytime you need to verify the integrity of controller-drive communication. Using a test program such as Reliability can give more information about a problem condition existing with a controller or peripheral.*

#### Description of PIO and CB Error Reporting

The Reliability programs use the same command protocol, Control Block (CB) and Programmed Input/Output (PIO), as the system does. An error can occur while the Reliability test program is executing either type of command. When a Control Block has a failure, you will see an error reported on your console. The disk and tape error reports look slightly different:

```

***** ERROR REPORT *****
RUN TIME 0. HRS. 0. MINS. 51. SECS. 2 TENTHS.
DEVICE CODE: 23 UNIT #: 0.
FILE #: 0 RECORD #: 0
REQUESTED # OF RECORDS: 1 BYTES/RECORD: 200
ACTUAL # OF RECORDS: 0 BYTES/RECORD: 0
COMMAND: READ/ONE WORD/VERIFY ACTIVE DATA TYPE: -ALLZ
PAGE ADDR: 0 XFER ADDR: 5072 ACTUAL ADDR: 5072
ASYNC STATUS : 3
CB EXECUTION ERROR: HARD ERRORS
CB STATUS : 100001
ANY CB HARD EXECUTION ERROR
CB DONE BIT
CB ERROR : 20
VERIFY ERROR
CB UNIT STATUS : 0
SENSE KEY : 0
NO SENSE BEING REPORTED
ERROR BYTE : 0

```

*Figure 3.6a  
CB Type Error Report - Tape*

```

***** ERROR REPORT *****
RUN TIME 0. HRS. 20. MINS. 3. SECS.
DEVICE CODE: 24 UNIT #: 0. MAPPING NOT ENABLED
STATE: **ACTIVE**
MODES: - RANDOM, R/W, DATA CHECK - ADDR
LOGICAL BLOCK 124532 SECTOR COUNT 4
MEMORY ADDRESS 64321 COMMAND WRITE
PAGE TABLE ADDRESS 0 RETURNED XFER COUNT 0
PHYSICAL BLOCK: 125452 =CYLINDER: 123 HEAD: 3 SECTOR: 34
ACTIVE DATA TYPE: -ALL0
ASYNC STATUS : 3
CB EXECUTION ERROR: HARD ERRORS
CB STATUS : 100001
ANY CB HARD EXECUTION ERROR
CB DONE BIT
CB ERROR : 20
HEADER NONCOMPARE
CB UNIT STATUS : 24000
READY
PORT RESERVED BIT 1
DISK ERROR : 5000
    
```

*Figure 3.6b*  
*CB Type Error Report - Disk*

A PIO Command can error or never complete, and the message will take this form for tape and disk RELI:

```

***** ERROR REPORT *****
RUN TIME 0. HRS. 2. MINS. 2. SECS. 3 TENTHS.
DEVICE CODE: 23 UNIT #: 0. MAPPING NOT ENABLED
CURRENT FILE:27936. CURRENT RECORD:28277. EOTS REACHED:28021
STATE: HALTED MODE: SEQUENTIAL, READ/WRITE, DATA CHECK-ADDR
REG A REG B REG C
OPERATION 0 10707 73
STATUS 0 10707 142073
DEVICE STATE : FULLY INITIALIZED
CB BUFFER STATE : NOT FULL
EXECUTION STATUS : ILLEGAL COMMAND
COMMAND : GET UNIT INFO

ENTER A COMMAND (MENU TO LIST COMMANDS): L
    
```

*Figure 3.6c*  
*PIO Type Error Report - Tape*

```

***** ERROR REPORT *****
RUN TIME 0. HRS. 4. MINS. 7. SECS. 4 TENTHS.
DEVICE CODE: 64 UNIT #: 0. MAPPING NOT ENABLED
STATE: **ACTIVE**
MODES: RANDOM, READ/WRITE, DATA CHECK-ADDR
          REG A      REG B      REG C
OPERATION 0          11554      73
STATUS    0          10        144073
DEVICE STATE : FULLY INITIALIZED
CB BUFFER STATE : NOT FULL
EXECUTION STATUS : EXECUTION ERROR
COMMAND : GET UNIT INFO
UNABLE TO GET UNIT INFORMATION.

```

*Figure 3.6d*  
*PIO Type Error Report - Disk*

With the Reliability program it is never necessary to look up the bit meaning of status returned from the program because it is interpreted for you.

If a PIO command never completes, the controller will never issue an interrupt to report completion and a Timeout error message will be reported by the program in a PIO Type Error Report.

### *Tape Hard Error Messages*

As tapes are used, they develop bad spots. It is up to the tape drive to handle as much of the bad portion as possible and report an error when it cannot. For example, the Exabyte tape drive has excellent ECC and a generous retry algorithm. The ECC recovers read data on bad spots. The retries ensure a good write. Therefore, a Hard Error that occurs most often would mean you should clean the tape heads or use new media.

*Data Compare  
Errors Can  
also Occur*

When the VERIFY option of the Reliability program is selected, the program writes data, reads it back and compares the data read into memory with what should have been written. If the data doesn't agree, an error report is generated.

```

***** DATA ERROR REPORT *****
RUN TIME 0. HRS. 0. MINS. 31. SECS. 9. TENTHS
DEVICE CODE: 23 UNIT NUMBER 0.
FILE #: 0 RECORD #: 0
REQUESTED # OF RECORDS: 1 BYTES/RECORDS: 200
PAGE ADDR: 0 XFER ADDR: 42630 ACTUAL ADDR: 42630
ACTIVE DATA TYPE: ALLZ
EXPECTED RECEIVED OFFSET
0 177777 0
0 177777 1
0 177777 2
0 177777 3
0 177777 4
0 177777 5
0 177777 6
0 177777 7
0 177777 10
0 177777 11
TOTAL ERROR COUNT: 64.
    
```

*Figure 3.6e  
RELI Data Compare Error - Tape*

```

***** DATA COMPARE REPORT *****
DEVICE CODE: 24 UNIT NUMBER 0. MAPPING NOT ENABLED
STATE: **ACTIVE**
MODES: RANDOM, R/W, DATA CHECK - ADDR
LOGICAL BLOCK : 2345 SECTOR COUNT : 3
PAGE TABLE ADDRESS : 0 LOGICAL XFER ADDRESS: 56271
PHYSICAL XFER ADDRESS : 56271
EXPECTED RECEIVED OFFSET
165346 165347 1
165346 165347 3
165346 165347 5
TOTAL ERROR COUNT: 384.
RUN TIME 0. HRS. 5. MINS. 12. SECS. 7. TENTHS.
    
```

*Figure 3.6f  
RELI Data Compare Error - Disk*

When Data Compare errors occur, the Controller is the most probable cause. You could also try different BMC cables or replace the paddleboard and cables to the drive.

This type of error does not indicate bad media or dirty tape heads; those would cause a tape hard error or a disk ECC uncorrectable hard error.



### *3.7 Error Messages From the System*

*Errors that occur while running the operating system are sometimes an annoyance and sometimes a catastrophe. Depending on the problem, the system will either react gracefully by informing you and continuing, or it will crash in a PANIC state.*

---

#### *Recovering From a PANIC*

It is difficult to know what causes a system crash. The software just gets to an operational dead-end and shuts down. A PANIC code is usually reported; it may or may not offer significant help. In this situation two things can be helpful:

1. Assuming your system once did work, look at what you have recently changed. You may have changed something significant when installing the new peripheral. It could be something in the new GEN or a serious BMC conflict. Have you modified user software? Has something in the computer environment changed: temperature/humidity or a new electrical system? Try to narrow down, focus your suspicions and eliminate possibilities.
2. If you suspect that one of the devices in the system has a hardware problem, it is beneficial to run diagnostic tests. Data General's MVSYSYSTEMX works on the system as a whole. Individual subsystems can be tested using a Reliability program such as Zetaco provides with its products.

#### *Using MVSYSYSTEMX*

This test is valuable to run because you don't need to involve your operating system (which may help to eliminate variables in trouble-shooting the problem) and it tests all the hardware. It is like a mini operating system. Refer to the system user documentation for instructions on how to run MVSYSYSTEMX and interpret its error messages.

*Using CONTEST*

The primary purpose of Data General's CONTEST, which is a diagnostic tool that runs under the operating system, is to test the disk drive. If you are dealing with a panic situation, you will have to bring up your operating system.

To test the disk portion of the controller using CONTEST, your current directory must reside on the disk unit to be tested. For example, if the SKM is a data disk whose LDU name is DATA1, "DIR" over to DATA1 and type CONTEST. Your searchlist must include :UTIL.

CONTEST also tests the primary tape device if the tape is an MTJ device. If you have an MTA, MTC, or an MTD drive enabled for your system, you will not be able to run an MTJ device under CONTEST.

Even if you have an MTJ as the primary tape device, you will not be able to run an MTJ secondary device. The only solution to this limitation would be to have a special version of the system, with only the driver of tape device you want to test enabled. This may be more bother than it is worth.

*System Error  
Without  
PANIC Crash*

When the system is able to read error status from a function it is performing, report it, and continue, you will have a better chance of determining what the problem is. For one thing, the device code of the device in an error state is reported.

Quite often the error can be the fault of another device. For example, if a high priority BMC device has a high burst rate configured with a low break count, other devices may have difficulty getting on the bus and will report errors. Changes may have to be made to both device configurations.

The error reported from the system may take a cryptic form. It may be a CB status or a PIO status taking the form of an octal number. Use Section 3.8 to help decipher these.

### 3.8 Interpreting Disk & Tape Commands and Status

*Driver status returned from the system or reliability program usually takes the form of an octal number that needs to be deciphered.*

#### 3.81 Tape Status

The tape driver uses two kinds of command structures:

**CONTROL BLOCK (CB):** Formal structures built in memory containing command and address information.

**PROGRAMMED INPUT/OUTPUT (PIO):** Single word registers containing different information depending on when you read or write them.

The address of the CB to be executed is passed from system to controller via a PIO register command.

Once either type of command is completed, the controller issues one of two types of interrupt to the system: asynchronous after a CB completes, and synchronous after a PIO command is done.

#### CB Status Meaning

Generally, if the completed command was a CB, you will get back: CB status, Error status or Unit status. These are written by the controller into a special part of the CB reserved for status, and are read by the system.

**Table 3.81a**

#### **Meaning of Tape CB Status**

The CB status word is reported in word 11 of the CB status block:

BIT	0	CB hard execution error
	1	CB Interpretation error
	2	Soft error executing CB
	3	Not used
	4	ECC correction used to recover
	5	ECC correction tried but failed
	6	Actual record count does not match request
	7-14	Not used
	15	CB done

**Table 3.81b**

***Meaning of Tape CB Error***

The CB Error word is reported in word 14 of the CB status block:

BIT	0	Controller interrupt timeout
	1	Controller/unit interface fault
	2	Controller timeout
	3	Data late
	4	Not used
	5	Unit error
	6	BMC timeout
	7	BMC ending memory address error
	8	Bad spot on tape
	9	Write protection fault
	10	Density mismatch
	11	Read/verify error
	12	BMC address/data transfer parity
	13	Controller to unit transfer parity
	14	Unit to media transfer parity
	15	Bad tape preamble

**Table 3.81c**

***Meaning of Tape CB Unit Status***

The Unit Status word is reported in word 15 of the CB status block:

BIT	0	Unit command failed
	1	Unit power fail
	2	Unit READY
	3	Not used
	4	Reserved by other port
	5	Reserved by this port
	6	Hard unit failure
	7,8,9	Not used
	10	Indecipherable dump format
	11	BOT
	12	EOF
	13	Logical EOT
	14	Physical EOT
	15	Not used

***Tape Error Code Word***

Word 20 of the returned CB status is the Tape Error Code. These are bytes passed from the drive to controller following an error condition. They are further defined as the tape drive Sense Key in the upper byte, and the Additional Sense Code in the lower byte. When a CB type error occurs during the Tape Reliability program, these bytes are displayed as Sense Key and Error Byte, as shown in Figure 3.6a. A list of Sense Keys for each drive is provided in Appendix A. For a list of all Additional Sense Codes, refer to the peripheral manufacturers specifications.

*PIO Status  
Meaning*

The PIO registers also get status written into them. When a CB completes, the PIO register C is used. When a PIO command, (which mostly has to do with getting a CB issued) completes in error, PIO register B is used.

**Table 3.81d**

***Meaning of Tape PIO Register C***

Bits 6 through 15 of REGISTER C after an asynchronous interrupt:

ASYNC OCTAL CODE	INTERRUPT NAME
0	Null interrupt
1	Controller panic
2	Soft error
3	Hard error (restart required)
4	lbit set
5	Completed without error
6	Cancel list
7	Sbit set (restart required)
10	Interpretation error; CB status word not 0
11	Interpretation error; Illegal command
12	Interpretation error; Range error
13	Interpretation error; Illegal unit
14	Interpretation error; Illegal Link address
15	Interpretation error; Illegal Page address
16	Interpretation error; Illegal Transfer address
17	Interpretation error; Illegal Trans byte count
20	Unreadable CB
21	Unwritable CB
22	Map slot load request
23	Unit status change
24	Position status (EOF, EOT, LEOT, PEOT) no restart
25	Interpretation error; Illegal transfer count

**Table 3.81e*****Meaning of Tape PIO Register B***

A PIO Get, Set or Program Load command error may set a bit in REGISTER B:

BIT	0-6	Not used
	7	Ending memory address error
	8-11	Not used
	12	BMC error
	13-15	Not used

### 3.82 Disk Commands and Status

#### *DPJ Commands*

There are some Disk commands that are interpreted and executed differently than Argus by the SKM controller.

**Table 3.82a**

#### ***Disk PIO Commands Implementation***

The following list includes PIO commands implemented in a different manner than Data General protocol, and the result of executing the command.

PIO EXECUTION	RESULT OF COMMAND EXECUTION
Sysgen Extended Status, Unit 0	NOP Returns Zetaco microcode revision number in DIA and DIB.
Ext. Status Unit 1	NOP
Ext. Status Unit 2	NOP
Ext. Status Unit 3	NOP
Start List High Priority	Start List
Cancel List	NOP

**Table 3.82b**

#### ***Disk Control Block Command Implementation***

Some CB Commands that are redefined by the SKM are listed below with the result of execution.

CB COMMAND	RESULT OF EXECUTION
Read/Verify	NOP
Read Raw Data	Illegal CB
Read Headers	Illegal CB
Write/Verify	Write
Write/Verify/Single Word	NOP

*Status Information*

At the conclusion of command processing, there are two types of interrupts to the host that can be generated by the SKM following Argus protocol: synchronous and asynchronous. An asynchronous interrupt occurs when the controller completes a CB or CB LIST, or when an error occurs during CB EXECUTION. A synchronous interrupt, when enabled, occurs after a PIO Command executes.

Synchronous interrupts have priority over asynchronous interrupts. If a synchronous interrupt occurs, synchronous return information will replace asynchronous return information in the status registers.

The status words produced by the various reporting mechanisms are:

- **Control Block** - CB status, error status, unit status.
- **Status Register** - Command status (execution state and Start List), command completion status, and asynchronous interrupt code.
- **Command Status** - Begin, Get and Set, Get List Status, Program Load, Reset and Unit Status.

*Table 3.82c*

***Disk PIO Register Status Implementation***

Asynchronous interrupt codes are written into bits 6-15 of status register C. The codes and their meaning reported by the SKM are as follows:

OCTAL CODE	INTERRUPT NAME
0	Null interrupt
1	Not Used
2	CB Execution error; soft
3	CB Execution error; hard
4	CB Complete; lbit set
5	CB Complete, no errors
6	Not Used
7	Soft error; Sbit set
10	Status word not zero
11	Illegal CB command
12	Not Used
13	Illegal page address
14	Not Used
15	Illegal page address
16	Illegal memory transfer address
17	Not Used
20	Unreadable CB
21	Unwritable CB
26	Soft error 0 mirrored pair



When a PIO command execution error occurs after issuing a Get or Set or Program Load command, status register B will contain a word with the following bit meanings from the SKM.

*Table 3.82d****Disk PIO Register B Status***

DIB BIT	MEANING
0 - 6	Not Used
7	Ending Memory Address error
8 - 11	Not Used
12	BMC error
13 - 15	Not Used

***CB Status Implementation***

There are two parts to a control block: Host-supplied (command) information and Return/Error information. There are three words in the controller Return/Error section of a CB returned by the SKM. They are: CB Status in word 11, Error Status in word 14, and Unit Status in word 15.

*Table 3.82e****Disk CB Status Word***

The CB Status word provides an overall view of operation. Its bit meanings can be interpreted as:

CB STATUS WORD BIT	MEANING
0	CB hard execution error
1	CB interpretation error
2	Soft error while execution CB
3	Not Used
4	ECC correction used to recover
5	ECC correction tried but failed
6	Sector relocated
7-14	Not Used
15	CB done

**Table 3.82f****Disk CB Error Word**

The CB Error word describes the condition of the controller and drive interface. Its bit meanings are as follows:

CB ERROR WORD BIT	MEANING
0	Not Used
1	Drive Interface fault *
2-4	Not Used
5	Drive error **
6	BMC Timeout error
7	Ending Memory Address error
8-10	Not Used
11	Verify error
12	BMC error
13	Not Used
14	ECC detected
15	Header error

- \* This error can be caused by:
- BMC error during sector transfer
  - Illegal unit
  - Illegal logical block
  - Bad sector log not terminated by -1
  - Any hard error on relocation log read
  - Any hard error on read/write of a relocated sector

- \*\* This error can be caused by:
- No unit response
  - Seek error
  - Cylinder address error
  - No headers found
  - Unit faulted
  - Clock error (servo or read)

**Table 3.82g****Disk Unit Status Word**

The Unit Status word is used to report the condition of the drive. The bit meanings are:

UNIT STATUS WORD BITS	MEANING
0,1	Not Used
2	Drive Ready
3-5	Not Used
6,7	Unit Number
8-15	Not Used

---

***Disk Error Code  
Word***

Word 20 of the returned CB status is the Disk Error Code. These are bytes passed from the drive to controller following an error condition. They are further defined as the disk drive Sense Key in the upper byte, and the Additional Sense Code in the lower byte. When a CB type error occurs during the Disk Reliability program, these bytes are displayed as Disk Error as shown in Figure 3.6b. A list of Sense Keys for each drive is provided in Appendix A. For a list of all Additional Sense Codes, refer to the peripheral manufacturers specifications.

**3.9 Help is Available for Problem Situations**

*An 800 number is available to OEMs for assistance, and Zetaco has a 48-hour turnaround policy on controller repairs.*

---

**You Can Use the Customer Support Hotline**

Zetaco provides a Customer Support Hotline to answer technical questions and to assist with installation and help trouble-shoot problems. The Hotline technical team is available from 8:00 a.m. to 5:00 p.m. (CST), Monday through Friday.

*Within the U.S. dial . . . . . 1-800-537-5292*

*Outside the U.S. dial . . . . . 1-612-890-5135*

**How to Get a Return Material Authorization (RMA)**

A Return Material Authorization number is required before shipping anything back to Zetaco. It should be referenced on the package and in any correspondence about the return. To get an RMA number:

1. Fill out a copy of the Material Return Information form shown on the next page and be prepared to give some of this information on the phone if asked. A copy of the filled out form should also be sent with any return package.
2. Call the Customer Support Hotline to request an RMA number from them.

Each product being returned needs a separate RMA number and Material Return Information form. It should be shipped to Zetaco, 11400 Rupp Drive, Burnsville, MN, 55337, freight prepaid.

Upon Zetaco's verification of defect, defective parts shall be repaired or replaced, and returned surface freight prepaid to the customer. In most cases, the Controller will be shipped back to you within two working days.

To safeguard the product during shipment, please use packaging that is adequate to protect it from damage. It would be a good idea to keep the original packaging for this purpose. Mark the box: *Delicate Instrument*. Indicate the RMA number(s) on the shipping label.

*Information*  
*About Warranty*

SKM Subsystems are warranted free from manufacturing and material defects, when used in a normal and proper manner, for a period of two years from date of shipment.

**Except for the express warranties stated above, Zetaco disclaims all warranties including all implied warranties of merchantability and fitness. The stated express warranties are in lieu of all obligations of liabilities on the part of Zetaco for damages, including but not limited to, special, indirect or consequential arising out of or in connection with the use or performance of Zetaco's products.**

If a part is no longer under warranty, or if the problem is not warranted (as set forth above), then repair will be billable to the customer.



# Material Return Information

The speed and accuracy of a product's repair is often dependent upon a complete understanding of the user's check-out test results, problem characteristics, and the user system configuration. Use the form below to record the results of your trouble-shooting procedures. If more space is needed, use additional paper.

## TEST

## RESULT

Power-up self-test

---

---

Other tests performed (system operation, errors, etc.):

Please allow our service department to do the best job possible by answering the following questions thoroughly and returning this information with the malfunctioning board.

1. *Does the problem appear to be intermittent or heat sensitive? (If yes, explain.)*
2. *Under which operating system are you running? (AOS/VS, AOS/VS-II) Include revision number.*
3. *Describe the system configuration (i.e., peripherals, controllers, model of computer, etc.):*
4. *Has the unit been returned before?  
Same problem?*

To be filled out by CUSTOMER:

MODEL NUMBER: \_\_\_\_\_

SERIAL NUMBER: \_\_\_\_\_

RMA NUMBER: \_\_\_\_\_ *(Call Zetaco to obtain an RMA number.)*

Returned by:

Your Name: \_\_\_\_\_ Firm: \_\_\_\_\_

Address: \_\_\_\_\_ Phone: \_\_\_\_\_





---

## Usage Guidelines

### ***4.1 Using the Tape Subsystem Efficiently***

*Its high capacity, small cartridge tape, and compatibility with an effective Data General driver make the SKM 8mm Tape Subsystem an attractive package. Use it in a manner that accentuates these features.*

Please be aware of the following:

HIGH CAPACITY . . . It takes a LONG time to get to EOT.

MTJ DRIVER . . . . . This driver is not available with all revisions of AOS/VS.

CARTRIDGE TAPE . . Your archive is only as good as the quality of the tape you buy and how you store it.

As with any subsystem, knowing how to USE the features of the SKM 8mm Tape is an important part of the feature.

### ***4.11 Setting up a Back-up Program***

*The beauty of a high capacity tape is that you don't have to stick around to put another reel of blank tape on the drive during back-up.*

---

The SKM 8mm Tape is best used as a back-up, archival device. It would take a long time to retrieve a file for a user application on line. The tapes are long and making a user wait is not cost effective.

It is cost effective to use the cartridge tape for back-up. In this application, the length of the tape is its advantage. A large amount of data can be stored on one tape, (which may eliminate the need for several reels) and the cartridges are small. This saves on storage and personnel costs.

### ***A Word About Block Size***

The tape drive writes data to tape in 1 *KB* blocks. This is done to facilitate its Helical Scan Technology. If a DUMP command is initiated using a block size that is less than 1 *KB* or not a multiple of 1 *KB*, the drive leaves the extra space blank. This will amount to a waste of tape.

### ***Writing a Back-up Macro***

With AOS/VS, it is possible to QBATCH or QSUBMIT commands for a specific day and time. The QBATCH or QSUBMIT could become part of a daily start up program. This allows you to stack up a back-up command that will not be performed until late at night. The following is an example:

```
QSUBMIT/AFTER=[!DATE]:20:00:00/QOUTPUT=@NULL BACK_UP_FILE
```

(QBATCH can be substituted for QSUBMIT.)

This command string waits until 8:00 P.M. to execute the commands in the file BACK\_UP\_FILE. Another method to use is:

```
QBATCH/AFTER=+12/QOUTPUT=@NULL BACK_UP_FILE
```

The commands in the file BACK\_UP\_FILE would execute after 12 hours had passed.

The file `BACK_UP_FILE` is set up to contain the actual commands to the MTJ tape drive. It looks something like what is shown in Example 4.1a. Basically, the file sets up commands for a given directory, writes the start time and the directory name to the file `USER.BACKUP.LIST` and does the work. When it is done it issues a rewind.

***Example 4.1a***  
***Partial AOS/VS***  
***BACK\_UP\_FILE***

```
REWIND @MTJ0
WRITE/L=USER.BACKUP.LIST FIRST DUMP STARTED AT [!TIME] ON [!DATE]
DIR :
WRITE/L=USER.BACKUP.LIST DUMPING UDD TO MTJ0 FILE 0
DUMP/BUFF=16384/L=USER.BACKUP.LIST @MTJ0:0 UDD:#\+.LS\+.PS\+.TMP
WRITE/L=USER.BACKUP.LIST DUMPING MACROS TO MTJ0 FILE 1
DUMP/BUFF=16384/L=USER.BACKUP.LIST @MTJ0:1 MACROS:#
```

and so on...

## **4.12 Commands MTJ Understands**

*The SKM 8mm Tape will function with any MV computer running AOS/VS or AOS/VS II that supports the MTJ driver. The MTJ driver responds to all standard tape commands.*

---

The SKM 8mm tape writes all tapes in the same density. You can omit density switches from all tape commands.

### *Tape Commands in AOS/VS*

There are five commands commonly issued to a tape drive in AOS/VS through the CLI. They are:

DUMP, LOAD, DUMP\_II, LOAD\_II, REW

REWIND has no options. It returns the tape to BOT.

DUMP and DUMP\_II share the same command format. DUMP\_II has some command switches that will not work with DUMP. DUMP\_II has the capability to be faster than DUMP. It uses more system resources (like memory). The amount of time saved depends on the availability of those resources to the DUMP\_II program.

The commands are issued slightly differently, too. Since DUMP\_II is a system utility, (the file DUMP\_II.PR is in :UTIL) you must type XEQ (or X) DUMP\_II.

Examples of DUMP/DUMP\_II commands:

```
DUMP/V/R/BUFF=16384 @MTJ0:0 UDD:USER:+  
XEQ DUMP_II/V/R/BUFF=16384 @MTJ0:0 UDD:USER:+
```

Either of the resulting tapes could be read using LOAD or LOAD\_II. (Do not mix formats on the same tape.)

LOAD and LOAD\_II use the same command format. Any switch that will work on one will work on the other. LOAD\_II has the capability to be faster than LOAD, when it has system resources available.

Examples of LOAD/LOAD\_II commands:

```
LOAD/V/R/BUFF=16384 @MTJ0:0  
LOAD_II/V/R/BUFF=16384 @MTJ0:0
```

*Creating a  
Physical Copy of  
Your Disk in  
AOS/VS*

When you use DUMP or DUMP\_II, you specify on the command line which files to save by using a file template. This requires that the system spend time deciding what to write. A speedy alternative to this process is PCOPY. PCOPY copies every used block of a disk onto tape. It can be used as a stand alone program, booted outside of the operating system, or in stand-among mode. Either way, it is faster than a regular DUMP.

### ***4.13 Caring for the Tapes & Tape Drive***

*It pays in terms of saved time, data and money, to use quality 8mm cartridge tapes, store them properly, and clean the tape drive on a regular basis.*

---

#### ***Which Tapes to Use***

Although the 8mm tape format is common enough to find at a corner drug store, you cannot be sure of the quality of the tape you buy. Since your data integrity depends on this quality, Zetaco recommends that you exclusively use **EXABYTE 8mm tapes.**

These are available from Zetaco and EXABYTE in these sizes:

<b><u>Cartridge Size</u></b>	<b><u>Length (feet)</u></b>	<b><u>Maximum Capacity (MB)</u></b>
256	45	291
512	90	583
1024	180	1166
2048	360	2332

#### ***Advice on Storing Tapes***

It is a good idea to examine the environment in which the tapes will be stored according to these guidelines:

- . . . Store the tapes vertically in their own case.
- . . . Temperature should not exceed 15°C to 25°C
- . . . Relative Humidity between 40 to 60% non-condensing.
- . . . Avoid storage in places with dust, direct sunlight, or moisture.
- . . . Keep tapes away from sources of magnetism.

#### ***Advice on Handling & Using Tapes***

Follow these guidelines while you are using the tapes:

- . . . Allow tape to acclimate to its environment for 24 hours or however long it has been exposed to other conditions, whichever is less.
- . . . Operating temperature should be maintained between 5°C to 40°C.
- . . . Relative Humidity between 20 to 80% non-condensing.
- . . . Remove old labels instead of covering.
- . . . Do not open cartridge lid or touch the tape.
- . . . Do not try to open the cartridge or splice the tape.

*Advice on  
Cleaning the  
Tape Drive*

As a preventative measure, it is recommended that you clean your tape drive at regular intervals determined by use. In an environment that adheres to the stated guidelines, this would be **once a month or after about 30 gigabytes of data transfer**. (To help plan this, about 1 gigabyte of data is transferred during every hour of continuous streaming operation.)

**ONLY** the Cleaning Kit supplied by Zetaco or Exabyte can be used to clean the drive. Use of cloth, cotton swabs, and wet cleaning agents other than FREON TF reagent grade, are not acceptable substitutes and will **VOID YOUR WARRANTY**.

Insert the cleaning tape into the drive. The drive will recognize it as a cleaning tape; the cleaning material will be loaded into the tape path and moved forward for about 15 seconds. Then the tape will be drawn back into the cartridge and the cartridge ejected. The drive will be ready for use. Complete instructions are supplied with the Cleaning Kit.

The cleaning tape is designed to be used three times and then discarded. You should never attempt to rewind and reuse the cleaning tape. This would reintroduce dirt into the tape path. If read/write problems are occurring, it is recommended that you use two cleaning passes in a row.

For more information on how to order the Cleaning Kit, call the Zetaco Sales department.

## ***4.2 Installing Add-On Disk and Tape Drives***

*Add-on drives may either be rack-mount style or desk top. A common cable and connector type used on all packaging makes installation of add-on drives flexible and easy.*

---

### ***General Procedure***

**To install additional enclosures, go to Section 4.24.** Use these instructions when you are installing enclosures with disk or tape drives already installed in the enclosures and setup for the proper SCSI ID addresses.

**To install individual disk or tape drives into an enclosure, continue on to the following sections.** Step-by-step instructions are provided for preparing the drives and installing them into the enclosure.

### ***How Many Drives can be Added?***

Each controller is designed to support up to seven devices on its SCSI bus. You can use any combination of disk and tape within these constraints:

- Each device, including disk drives, tape drives and controller, on a single SCSI bus must each be assigned a unique SCSI ID in the range 0-7.
- The cumulative cable lengths of all drives attached to one controller must not exceed 25 meters (82 feet) for differential drives and 6 meters (19.6 feet) for single-ended. If there is cabling inside a peripheral enclosure, the length must be included in the total.
- A subsystem which utilizes dedicated SCZ-3 disk and SCZ-4 tape controllers can control up to 7 disk drives and 7 tape drives. Although the disk and tape drives are contained in the same peripheral enclosures, two independent SCSI busses are used, each of which must be terminated at the last enclosure.
- A subsystem which utilizes one SCZ-5 combination disk/tape controller can control any combination of disk and tape drives, up to 7 devices total. A single SCSI bus is used which must be terminated at the last enclosure.



### 4.21 Setting SCSI ID Addresses

As stated earlier, SKM subsystems which use dedicated disk and tape controllers can support up to 7 disk and 7 tape drives per two-controller subsystem. SKM subsystems which use a single combination disk/tape controller can support any combination of up to 7 disk or tape drives. Each controller uses one SCSI bus, and each bus is limited to 8 devices total including the controller.

Figure 4.21 is a view of the SKM rack mount enclosure with the top cover removed. It shows the positions for up to 4 disk drives and up to 2 tape drives. Tables 4.21a and 4.21b show the typical SCSI ID assignments for a subsystem with up to two enclosures and one tape drive. Table 4.21a is for subsystems with dedicated disk and tape controllers, and Table 4.21b is for subsystems with one combination disk/tape controller.

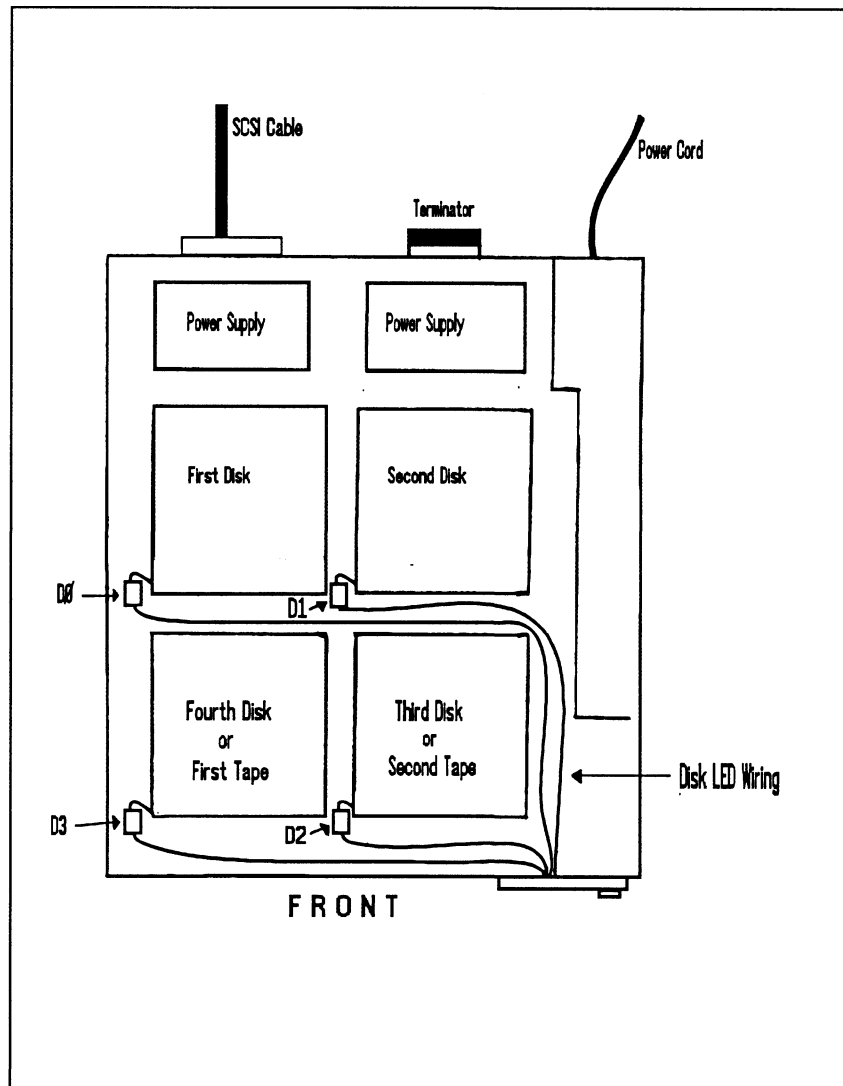

**Figure 4.21**  
*Disk & Tape Drive Placement*

Each drive installed in the SKM rack mount enclosure should have a "UNIT #" label affixed to the top of it. This number indicates the SCSI ID that the drive has been set to when installed in the enclosure.

Use the figure and tables to determine what SCSI IDs to set your peripherals, then refer to Appendix A for information on how to set the ID address on specific disk and tape drives. After changing the SCSI ID of a drive, update the "UNIT #" label, or add one if none exists, to show the current ID setting of the drive.

**Table 4.21a*****SCSI ID Assignments for SCZ-3/SCZ-4 Subsystems***

Typical assignments based on one tape drive

	1st Disk	2nd Disk	3rd Disk	4th Disk	1st Tape	2nd Tape
First Enclosure	0	1	2	-	0	-
Add-On Enclosure	3	4	5	6	-	-

**Table 4.21b*****SCSI ID Assignments for SCZ-5 Subsystems***

Typical assignments based on one tape drive

	1st Disk	2nd Disk	3rd Disk	4th Disk	1st Tape	2nd Tape
First Enclosure	0	1	2	-	3	-
Add-On Enclosure	4	5	6	-	-	-

#### ***4.22 Removing SCSI Terminators From Disk Drives***

Before installing the drive(s) into the enclosure, you must remove the SCSI termination resistors from the drives. SCSI bus termination for the SKM subsystems is provided by the terminator plug that attaches to the unused connector on the rear of the enclosure, not by the drives. The Exabyte tape drive (differential version) has no termination resistors.

For Seagate models ST4385N (Wren Runner) and ST4702N (Wren 5), remove the 3 DIP resistors and 6 SIP resistors located on the bottom circuit board of the drive. For Seagate models ST4767N (Wren Runner II) and ST41200N (Wren 7), remove the 3 DIP resistors on the bottom of the drive. The resistor packs are socketed in zero-profile sockets for field removal and replacement.

**4.23 Installing  
Add-on Drives  
Into The  
Enclosure**

**WARNING**

-----

**Be sure to disconnect the AC power cord from the enclosure before opening the top cover and installing the add-on drives. Also, before handling any equipment, take the necessary steps to prevent static electricity discharge from damaging your equipment. Do this by wearing a wristband strapped to earth ground.**

The following are step-by-step instructions to install a disk or tape drive into the SKM rack-mount enclosure. See Figure 4.23. Be sure that the drive option jumpers and switches are set correctly before installing the drive. See Section 4.21 and Appendix A.

**1. Parts and tools needed:**

Each drive requires the following parts for installation:

- Jumper cable (disk drives only)
- (4) 6/32 x .375" pan-head drive mounting screws

Tools needed include a straight and philips screwdriver.

**2. Slide the enclosure out of the rack and remove the cover.**

**3. Attach the mounting plate to the drive.**

- Remove the mounting plate for the location the drive is to be mounted by pushing the plate towards the rear of the enclosure while depressing the lock bracket. When the lock is released, pull the plate forward and remove it from the enclosure.
- Attach the mounting plate to the drive by placing the drive upside down on a flat surface. Position the mounting plate onto the drive, with the metal part of the plate towards the drive and the metal contact springs toward the rear. Attach the plate to the drive with the four mounting screws.

**4. Slide the drive onto the base plate in the enclosure. Do not push it all the way back at this time.**

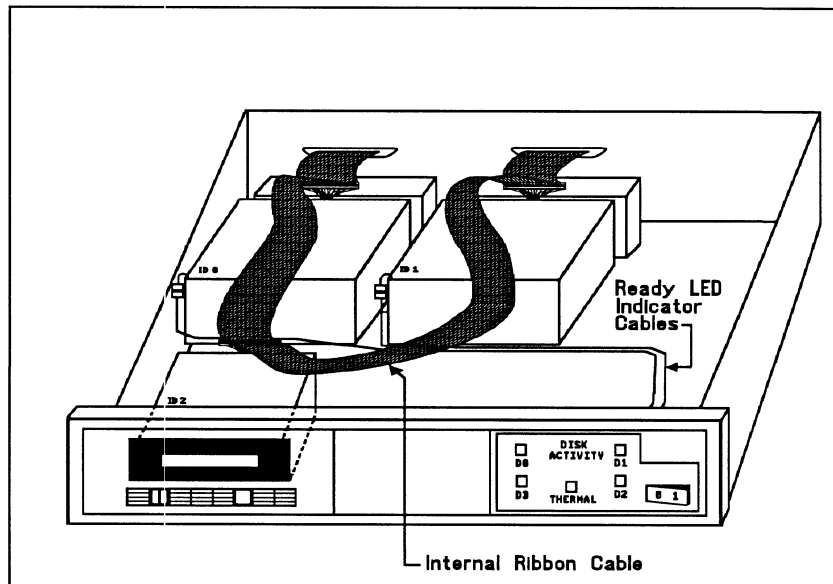

**Figure 4.23**  
*Add-on Drive Installation*

5. **For disk drives, connect the LED cable.** Couple the connector located at the front of the drive to the mating connector in the vicinity of the drive that runs to the enclosure front panel.

NOTE: There are guard sockets installed in the internal ribbon cable plugs at each drive slot position to prevent shorting. Remove these guards from each position to be used and save them for possible future use.

6. **For disk drives, connect the 4-inch interface cable.** Insert one end of the cable into the mating connector on the rear of the drive. Be sure to align pin 1 on the connector with pin 1 on the cable, indicated by a small triangle. Insert the other end of the interface cable into the internal ribbon cable, again aligning pin 1 on each cable.
7. **For tape drives, connect the enclosure internal cable to the connector on the tape drive.** Be sure to align pin 1 on the connector with pin 1 on the cable, indicated by a small triangle.
8. **Connect the 4 pin DC power cable to the drive.** The connectors are polarized to prevent wrong insertion. Push the cable securely into the drive connector.
9. **Push the drive back until the mounting plate snaps into place on the base plate.**

- 10. Re-attach the enclosure cover and push the enclosure back into the rack. Re-attach the power cable to the enclosure.**

## **4.24 Installing Add-On Enclosures**

Whenever possible, SKM add-on enclosures are factory set to the required SCSI ID addresses specified when the order is received. If you're not sure whether your add-on enclosure has been preset to the correct addresses, refer to Section 4.21. to check and set the individual drive addresses as required.

Choose a position within the equipment rack to mount the add-on enclosure. The position must be close enough to the first enclosure for the 2 ft. daisy chain cables to reach. If it cannot be mounted that close, longer daisy-chain cables must be used, provided the overall bus length does not exceed specifications.

### **FOR SUBSYSTEMS THAT USE SCZ-3 DISK AND SCZ-4 TAPE CONTROLLERS:**

Mount the add-on enclosures as described in Chapter 2. Remove the SCSI terminator plugs from the "Tape Out" and "Disk Out" connectors on the first enclosure and re-install them on the "Out" connectors on the add-on enclosure. Next, attach one of the daisy-chain cables received with the add-on enclosure from the "Disk Out" connector of the first enclosure to the "Disk In" connector of the add-on enclosure. Finally, attach the other daisy-chain cable from the "Tape Out" connector of the first enclosure to the "Tape In" connector of the add-on enclosure. Be sure to tie all enclosures to earth ground with a single-point ground system.

### **FOR SUBSYSTEMS THAT USE THE SCZ-5 COMBINATION DISK/TAPE CONTROLLER:**

Mount the add-on enclosure as described in Chapter 2. Remove the SCSI terminator plug from the first enclosure and re-install it on the add-on enclosure. Next, attach the daisy-chain cable from one connector of the first enclosure to the open connector of the add-on enclosure. Be sure to tie all enclosures to earth ground with a single-point ground system.

## 4.25 Cabling Issues

To comply with FCC regulations, all external cables must be shielded. It is necessary to use shielded cables with a characteristic impedance of 120 *ohms* (or greater) for single-ended drives, and 100 *ohms* (or greater) for differential drives. It is best to use cables of the same characteristic impedance on the same bus to minimize discontinuities and signal reflections. Call your distributor or a factory representative for more information on available cables and lengths. Do not exceed the maximum cumulative lengths given below.

Figure 4.25 depicts a series of enclosures. Add the cable lengths using the following formula to determine whether you are over the limit. (To convert to feet, 39.37 inches are in one meter.)

$$(.7 + L1 + L2 + \dots Ln) + (n \times 1.4)$$

where:  $n$  = number of devices on bus

$L$  = length in meters of cables between devices

Result must be less than or equal to:

25 meters for differential SCSI bus subsystems, or  
6 meters for single-ended SCSI bus subsystems

1. Add together all the lengths of shielded cables for all drives including the cable from the computer chassis. Also include the 0.7 meter used inside the HOST chassis.
2. Multiply the number of drives ( $n$ ) by 1.4. This represents the total cable length, in meters, found inside the drive enclosures.
3. Add the two numbers. The total must be equal to or less than the 25 meter limit for differential or 6 meter limit for single-ended.

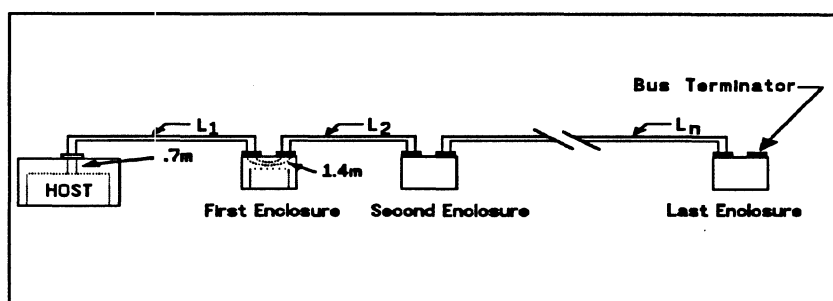

**Figure 4.25**  
*Multiple Enclosure Cable Length*



# Appendix A

---

## Peripheral Specifications

**A.1 Exabyte  
EXB-8200 &  
8500 8mm Tape  
Drive**

**A.11  
Specifications**

Recording Format . . . . . Helical Scan

Cartridge . . . . . 8mm Industry Standard

Cartridge Sizes

EXB 8200 . . . . . 512 - 5GB

EXB 8500 . . . . . 256 - 2300 MB

Error checking . . . . . Read after Write, Auto re-write

Non-Recoverable

Error Rate . . . . . less than one bit in  $10^{13}$  bits read

Buffer

EXB 8200 . . . . . 256KB

EXB 8500 . . . . . 1MB

Effective Head-to-Tape Speed . . . . . 150 inches/sec

SCSI Bus Data Transfer Rates . . . . . Up to 1.5 MB/sec

**Environmental**

Operating Environment:

Temperature . . . . . +5 to +40°C

Relative Humidity . . . . . 20% to 80% (non-condensing)

Altitude . . . . . -984.3 to +9843 feet

Non-Operating Environment:

Temperature . . . . . -45 to +115°C

Relative Humidity . . . . . 10% to 90% (non-condensing)

Altitude . . . . . -984.3 to +40,026 feet

**A.12 Setting  
SCSI ID Address**

There are three switches located on the rear of the tape drive used to select the SCSI ID. They correspond to the binary place values of 1, 2, and 4. A logic level of 0 corresponds to the switch OFF position, which is DOWN.

For a SCSI ID of 0, all three switches would be down. For a SCSI ID of 1, the leftmost switch would be UP and the other two DOWN. Figure A.12 shows the switch layout, and Table A.12 demonstrates all eight possible SCSI ID switch settings.

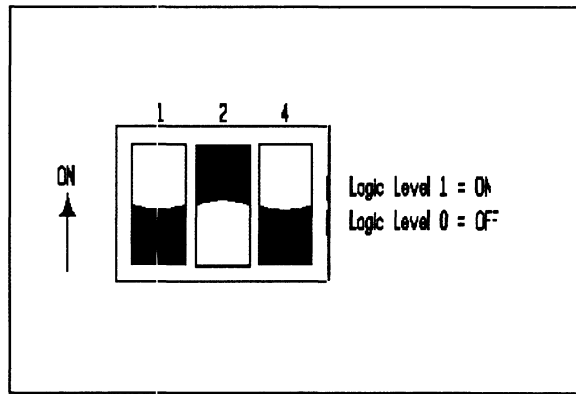

**Figure A.12**  
*SCSI ID Switches On EXB-8200 &  
EXB-8500 8mm Tapes*

**Table A.12**

**EXB-8200 & EXB-8500 8mm ID Switch Settings**

SW1-1	SW1-2	SW1-3	ID
OFF	OFF	OFF	0
ON	OFF	OFF	1
OFF	ON	OFF	2
ON	ON	OFF	3
OFF	OFF	ON	4
ON	OFF	ON	5
OFF	ON	ON	6
ON	ON	ON	7

### ***A.13 The Write Protect Tab***

The cartridge tape can be made read-only or writable by moving a tab on the tape cartridge. See Figure A.13. Remove the tape from the drive, and use a tool such as a ball point pen to move the tab, as shown below.

If red is visible in the recessed area at the bottom of the cartridge, the tape is *write-protected*. You will not be able to write on it or erase it. If no red is visible in this area, the tape is *write-enabled*.

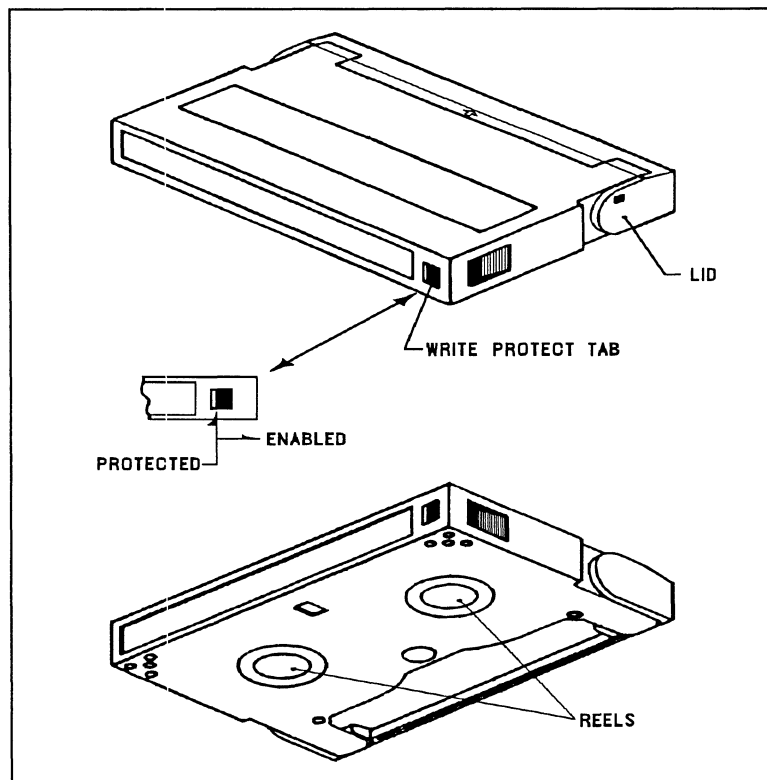

***Figure A.13***  
***Location of Write Protect Tab on 8mm Tape***

***A.14 Cartridge  
Tape LOAD &  
UNLOAD  
Procedures***

To **LOAD** the data cartridge into the drive:

1. Set the write protect tab the way you want it.
2. Press the button switch on the front panel to open the access door if it is not open.
3. Insert the cartridge, label side up, lid side first.
4. Gently close the access door. The drive will automatically load the tape.

To **UNLOAD** the data cartridge from the drive:

1. Press the button switch on the drive front panel. The green *Ready* LED will go OFF.
2. The drive will rewind the tape, unload, and eject the tape unless the drive is not turned on, or the drive is active with a SCSI command.

**A.15 Sense Key  
Descriptions**

The following are the defined Sense Keys returned in byte 2 of the drive Extended Sense bytes, and in the upper byte of word 20 of the Control Block status returned from the controller.

<b>SENSE KEY (HEX)</b>	<b>MEANING</b>
00	NO SENSE - There is no specific Sense Key information to report.
01	NOT USED
02	NOT READY - The tape drive unit is not ready to accept a command. This may be the result of the tape cartridge either not being inserted yet, or inserted but not yet ready to accept commands.
03	MEDIUM ERROR - Indicates the command terminated with a non-recovered error condition which was caused by a flaw in the tape.
04	HARDWARE ERROR - Indicates the drive encountered a non-recoverable hardware failure during operation or selftest.
05	ILLEGAL REQUEST - The drive received a command which contained an illegal parameter.
06	UNIT ATTENTION - This indicates that the tape cartridge may have been changed or the drive has been "reset" either by power down/up or a hard reset from the controller.
07	DATA PROTECT - Indicates a Write operation was attempted on a tape cartridge whose "Write-Protect" tab was in the Protected position.
08	BLANK CHECK - Indicates that the end of data or logically blank tape was encountered while reading.
09	EXABYTE - Indicates an error occurred defined by one of the following vendor unique bits:

**Tape Mark Detect Error (TMD)** - An error occurred while attempting to perform a Space Filemark resulting in an invalid tape position.

**Transfer Abort Error (XFR)** - An error occurred while attempting to pause the data transfer in preparation for a disconnect sequence.

**0A COPY ABORTED** - Not supported.

**0B ABORTED COMMAND** - Indicates an aborted operation occurred.

**0C NOT USED**

**0D VOLUME OVERFLOW** - Indicates the last Write request or Write Filemark command reached Physical End Of Tape, and that data remains in the drive buffer, or that the Filemarks were not correctly written.

**0E, 0F NOT USED**

**A.2 Seagate  
Wren Runner  
ST4385N (94181-  
385H/M)**

**A.21  
Specifications**

Formatted User Capacity (megabytes) . . . . .	330
Total User Blocks . . . . .	645,107
Block Size (bytes) . . . . .	512
Sizing Characteristics (reported to system)	
Cylinders . . . . .	253
Heads . . . . .	20
Sectors/track . . . . .	128
Sizing Characteristics (physical)	
Cylinders . . . . .	NA
Heads . . . . .	16
Sectors/track . . . . .	Varies
Recording Method . . . . .	Zone Bit Recording
Recording Density (Bits/Inch) . . . . .	22,000
Track Density (Tracks/Inch) . . . . .	1,280
Spindle Speed (RPM) . . . . .	3,600
Bit Transfer Rate (Mbits/sec.) . . . . .	15-16
SCSI Max. Transfer Rate (MBytes/sec.) . . . . .	4.7
Track-to-Track Seek Time (msec. typ.) . . . . .	3
Average Seek Time (msec. typ.) . . . . .	10.7
Maximum Seek Time (msec. typ.) . . . . .	22.5
Average Rotational Latency (msec. typ.) . . . . .	8.33
Nonrecoverable	
Read Error Rate . . . . .	1 per 10 <sup>12</sup> bits read



MTBF (POH) . . . . .	100,000
Operating Temperature . . . . .	10° to 50° C
Power Consumption (Watts typ.) . . . . .	21
Weight (typ.) . . . . .	7.6 lbs. (3.4 kg.)

**A.22 Setting  
SCSI ID Address**

Figure A.22 shows the SCSI ID jumper layout for the disk drive. The ID is set by the three binary-coded jumpers marked 4,2 and 1. The jumper positions for each SCSI ID value is shown on the right side of the figure. A jumper installed represents a binary "1" and no jumper represents a "0". To access the jumpers, the drive must be removed from the enclosure.

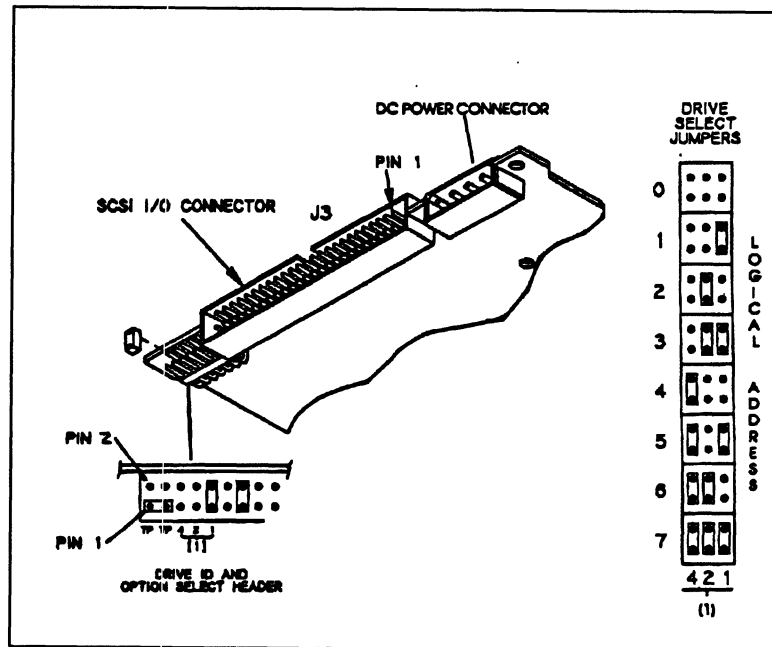

**Figure A.22  
Seagate ST4385N SCSI ID Jumpers**

***A.23 Sense Key  
Descriptions***

The following are the defined Sense Keys returned in byte 2 of the drive Extended Sense bytes, and in the upper byte of word 20 of the Control Block status returned from the controller.

**SENSE KEY (HEX) MEANING**

- 00 NO SENSE - There is no specific Sense Key information to report.
- 01 RECOVERED ERROR - The last command completed successfully with some recovery action performed by the drive.
- 02 NOT READY - The disk drive unit was not ready to accept a command.
- 03 MEDIUM ERROR - Indicates the command terminated with a non-recovered error condition which was probably caused by a flaw in the disk medium or an error in the recorded data.
- 04 HARDWARE ERROR - Indicates the drive encountered a non-recoverable hardware failure during operation or selftest. This includes SCSI bus parity errors.
- 05 ILLEGAL REQUEST - The drive received a command which contained an illegal parameter.
- 06 UNIT ATTENTION - This is used to indicate that the drive has been "reset" either by power down/up or a hard reset from the controller.
- 07 DATA PROTECT - Indicates a Write operation was attempted on a drive which was write-protected. Check the write protect jumper on the disk drive.

- 0B ABORTED COMMAND - Indicates an aborted operation occurred.
- 0D VOLUME OVERFLOW - Indicates the drive has reached end-of-medium, and that data remains in the drive buffer that has not been written to the disk.
- 0E Indicates the source data did not match the data read from the medium.

**A.3 Seagate  
Wren V ST4702N  
(94181-702/M)**

**A.31  
Specifications**

Formatted User Capacity (megabytes) . . . . .	601
Total User Blocks . . . . .	1,173,737
Block Size (bytes) . . . . .	512
Sizing Characteristics (reported to system)	
Cylinders . . . . .	459
Heads . . . . .	20
Sectors/track . . . . .	128
Sizing Characteristics (physical)	
Cylinders . . . . .	1,546
Heads . . . . .	16
Sectors/track . . . . .	Varies
Recording Method . . . . .	Zone Bit Recording
Recording Density (Bits/Inch) . . . . .	26,000
Track Density (Tracks/Inch) . . . . .	1,280
Spindle Speed (RPM) . . . . .	3,600
Bit Transfer Rate (Mbits/sec.) . . . . .	12-16
SCSI Max. Transfer Rate (MBytes/sec.) . . . . .	4.7
Track-to-Track Seek Time (msec. typ.) . . . . .	3
Average Seek Time (msec. typ.) . . . . .	16.5
Maximum Seek Time (msec. typ.) . . . . .	39
Average Rotational Latency (msec. typ.) . . . . .	8.33
Nonrecoverable	
Read Error Rate . . . . .	1 per 10 <sup>12</sup> bits read

MTBF (POH) . . . . .	100,000
Operating Temperature . . . . .	10° to 50° C
Power Consumption (Watts typ.) . . . . .	21
Weight (typ.) . . . . .	7.6 lbs. (3.4 kg.)

**A.32 Setting  
SCSI ID Address**

Figure A.32 shows the SCSI ID jumper layout for the disk drive. The ID is set by the three binary-coded jumpers marked 4,2 and 1. The jumper positions for each SCSI ID value is shown on the right side of the figure. A jumper installed represents a binary "1" and no jumper represents a "0". To access the jumpers, the drive must be removed from the enclosure.

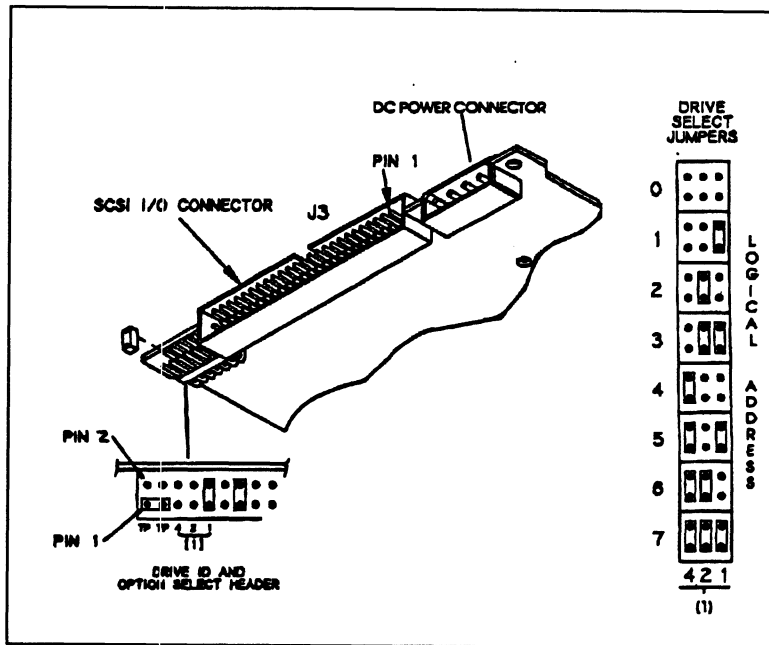

**Figure A.32**  
**Seagate ST4702N SCSI ID Jumpers**

### ***A.33 Sense Key Descriptions***

The following are the defined Sense Keys returned in byte 2 of the drive Extended Sense bytes, and in the upper byte of word 20 of the Control Block status returned from the controller.

#### **SENSE KEY (HEX) MEANING**

- 00 NO SENSE - There is no specific Sense Key information to report.
- 01 RECOVERED ERROR - The last command completed successfully with some recovery action performed by the drive.
- 02 N READY - The disk drive unit was not ready to accept a command.
- 03 MEDIUM ERROR - Indicates the command terminated with a non-recovered error condition which was probably caused by a flaw in the disk medium or an error in the recorded data.
- 04 HARDWARE ERROR - Indicates the drive encountered a non-recoverable hardware failure during operation or selftest. This includes SCSI bus parity errors.
- 05 ILLEGAL REQUEST - The drive received a command which contained an illegal parameter.
- 06 UNIT ATTENTION - This is used to indicate that the drive has been "reset" either by power down/up or a hard reset from the controller.
- 07 DATA PROTECT - Indicates a Write operation was attempted on a drive which was write-protected. Check the write protect jumper on the disk drive.

- 0B ABORTED COMMAND - Indicates an aborted operation occurred.
- 0D VOLUME OVERFLOW - Indicates the drive has reached end-of-medium, and that data remains in the drive buffer that has not been written to the disk.
- 0E Indicates the source data did not match the data read from the medium.

**A.4 Seagate  
Wren Runner II  
ST4767N  
(94601-767H/M)**

**A.41  
Specifications**

Formatted User Capacity (megabytes) . . . . .	665
Total User Blocks . . . . .	1,299,648
Block Size (bytes) . . . . .	512
Sizing Characteristics (reported to system)	
Cylinders . . . . .	508
Heads . . . . .	20
Sectors/track . . . . .	128
Sizing Characteristics (physical)	
Cylinders . . . . .	1,356
Heads . . . . .	15
Sectors/track . . . . .	64
Recording Method . . . . .	RLL (2,7)
Recording Density (Bits/Inch) . . . . .	30,600
Track Density (Tracks/Inch) . . . . .	1,600
Spindle Speed (RPM) . . . . .	4,800
Bit Transfer Rate (Mbits/sec) . . . . .	24
SCSI Max. Transfer Rate (MBytes/sec.) . . . . .	4.8
Track-to-Track Seek Time (msec. typ.) . . . . .	2.5
Average Seek Time (msec. typ.) . . . . .	11.9
Maximum Seek Time (msec. typ.) . . . . .	26
Average Rotational Latency (msec. typ.) . . . . .	6.25
Nonrecoverable	
Read Error Rate . . . . .	1 per 10 <sup>12</sup> bits read



MTBF (POH) . . . . .	100,000
Operating Temperature . . . . .	10° to 50° C
Power Consumption (Watts typ.) . . . . .	27
Weight (typ.) . . . . .	7.6 lbs. (3.4 kg.)

**A.42 Setting  
SCSI ID Address**

Figure A.42 shows the SCSI ID jumper layout for the disk drive. The ID is set by the three binary-coded jumpers marked 4,2 and 1. The jumper positions for each SCSI ID value is shown on the right side of the figure. A jumper installed represents a binary "1" and no jumper represents a "0". To access the jumpers, the drive must be removed from the enclosure.

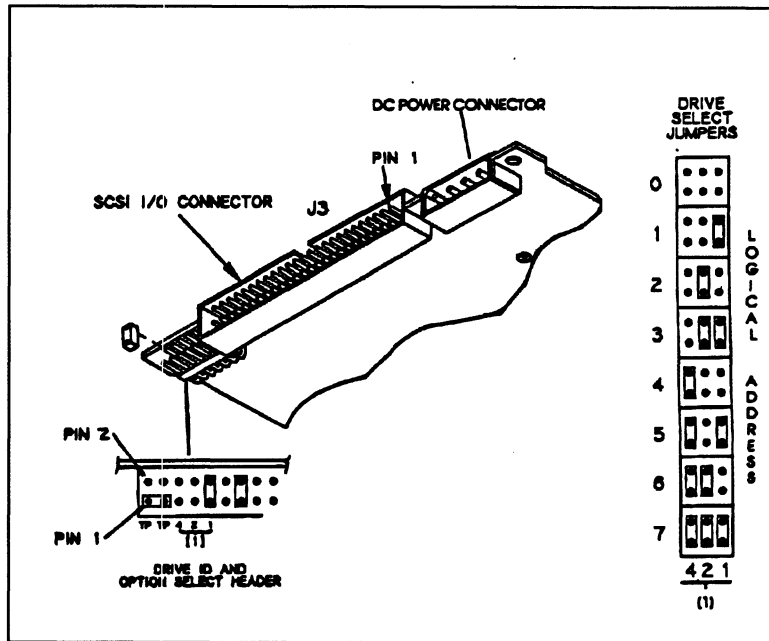

**Figure A.42**  
**Seagate ST4767N SCSI ID Jumpers**

**A.43 Sense Key  
Descriptions**

The following are the defined Sense Keys returned in byte 2 of the drive Extended Sense bytes, and in the upper byte of word 20 of the Control Block status returned from the controller.

**SENSE KEY (HEX)    MEANING**

- 00    NO SENSE - There is no specific Sense Key information to report.
- 01    RECOVERED ERROR - The last command completed successfully with some recovery action performed by the drive.
- 02    NOT READY - The disk drive unit was not ready to accept a command.
- 03    MEDIUM ERROR - Indicates the command terminated with a non-recovered error condition which was probably caused by a flaw in the disk medium or an error in the recorded data.
- 04    HARDWARE ERROR - Indicates the drive encountered a non-recoverable hardware failure during operation or selftest. This includes SCSI bus parity errors.
- 05    ILLEGAL REQUEST - The drive received a command which contained an illegal parameter.
- 06    UNIT ATTENTION - This is used to indicate that the drive has been "reset" either by power down/up or a hard reset from the controller.
- 07    DATA PROTECT - Indicates a Write operation was attempted on a drive which was write-protected. Check the write protect jumper on the disk drive.

- 0B ABORTED COMMAND - Indicates an aborted operation occurred.
- 0D VOLUME OVERFLOW - Indicates the drive has reached end-of-medium, and that data remains in the drive buffer that has not been written to the disk.
- 0E Indicates the source data did not match the data read from the medium.

**A.5 Seagate  
Wren VII  
ST41200N  
(94601-12G/M)**

**A.51  
Specifications**

Formatted User Capacity (megabytes) . . . . .	1,037
Total User Blocks . . . . .	2,026,773
Block Size (bytes) . . . . .	512
Sizing Characteristics (reported to system)	
Cylinders . . . . .	792
Heads . . . . .	20
Sectors/track . . . . .	128
Sizing Characteristics (physical)	
Cylinders . . . . .	1,931
Heads . . . . .	15
Sectors/track . . . . .	Varies
Recording Method . . . . .	Zone Bit Recording
Recording Density (Bits/Inch) . . . . .	32,750
Track Density (Tracks/Inch) . . . . .	1,600
Spindle Speed (RPM) . . . . .	3,600
Bit Transfer Rate (Mbits/sec) . . . . .	15-23
SCSI Max. Transfer Rate (MBytes/sec.) . . . . .	4.8
Track-to-Track Seek Time (msec. typ.) . . . . .	2.5
Average Seek Time (msec. typ.) . . . . .	15
Maximum Seek Time (msec. typ.) . . . . .	34
Average Rotational Latency (msec. typ.) . . . . .	8.33
Nonrecoverable	
Read Error Rate . . . . .	1 per 10 <sup>12</sup> bits read

MTBF (POH) . . . . .	100,000
Operating Temperature . . . . .	10° to 50° C
Power Consumption (Watts typ.) . . . . .	24
Weight (typ.) . . . . .	7.6 lbs. (3.4 kg.)

**A.52 Setting  
SCSI ID Address**

Figure A.52 shows the SCSI ID jumper layout for the disk drive. The ID is set by the three binary-coded jumpers marked 4,2 and 1. The jumper positions for each SCSI ID value is shown on the right side of the figure. A jumper installed represents a binary "1" and no jumper represents a "0". To access the jumpers, the drive must be removed from the enclosure.

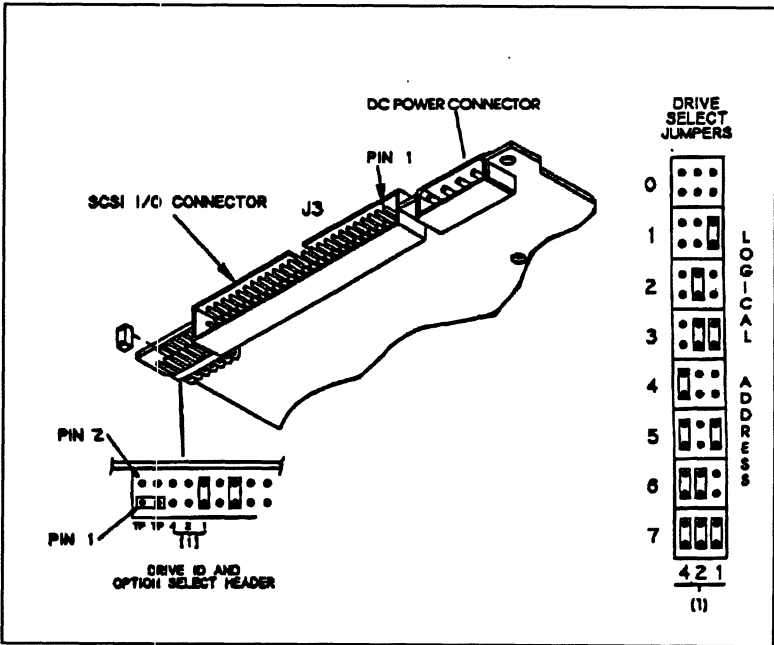

**Figure A.52  
Seagate ST41200N SCSI ID Jumpers**

**A.53 Sense Key  
Descriptions**

The following are the defined Sense Keys returned in byte 2 of the drive Extended Sense bytes, and in the upper byte of word 20 of the Control Block status returned from the controller.

**SENSE KEY (HEX)    MEANING**

- 00    NO SENSE - There is no specific Sense Key information to report.
- 01    RECOVERED ERROR - The last command completed successfully with some recovery action performed by the drive.
- 02    NOT READY - The disk drive unit was not ready to accept a command.
- 03    MEDIUM ERROR - Indicates the command terminated with a non-recovered error condition which was probably caused by a flaw in the disk medium or an error in the recorded data.
- 04    HARDWARE ERROR - Indicates the drive encountered a non-recoverable hardware failure during operation or selftest. This includes SCSI bus parity errors.
- 05    ILLEGAL REQUEST - The drive received a command which contained an illegal parameter.
- 06    UNIT ATTENTION - This is used to indicate that the drive has been "reset" either by power down/up or a hard reset from the controller.
- 07    DATA PROTECT - Indicates a Write operation was attempted on a drive which was write-protected. Check the write protect jumper on the disk drive.
- 0B    ABORTED COMMAND - Indicates an aborted operation occurred.
- 0D    VOLUME OVERFLOW - Indicates the drive has reached end-of-medium, and that data remains in the drive buffer that has not been written to the disk.
- 0E    Indicates the source data did not match the data read from the medium.

**A.6 Seagate  
Elite ST41600N**

**A.61  
Specifications**

Formatted User Capacity (megabytes) . . . . .	1,370
Total User Blocks . . . . .	2,676,654
Block Size (bytes) . . . . .	512
Sizing Characteristics (reported to system)	
Cylinders . . . . .	1046
Heads . . . . .	20
Sectors/track . . . . .	128
Sizing Characteristics (physical)	
Cylinders . . . . .	2,101
Heads . . . . .	17
Sectors/track . . . . .	varies
Recording Method . . . . .	RLL (2,7)
Recording Density (Bits/Inch) . . . . .	26-36000
Track Density (Tracks/Inch) . . . . .	1,801
Spindle Speed (RPM) . . . . .	5,400
Bit Transfer Rate (Mbits/sec) . . . . .	26-36
SCSI Max. Transfer Rate (MBytes/sec.) . . . . .	5.0
Track-to-Track Seek Time (msec. typ.) . . . . .	1.7
Average Seek Time (msec. typ.) . . . . .	11.5
Maximum Seek Time (msec. typ.) . . . . .	22.5
Average Rotational Latency (msec. typ.) . . . . .	5.55
Nonrecoverable Read Error Rate	
. . . . .	less than or equal to 10 in 10 <sup>15</sup> bits read

MTBF (POH) .....	150,000
Operating Temperature .....	5° to 50° C
Power Consumption (Watts typ.) .....	38
Weight (typ.) .....	8.0 lbs. (3.6 kg.)

**A.62 Setting  
SCSI ID Address**

Figure A.62 shows the SCSI ID jumper layout for the disk drive. The ID is set by the three binary-coded jumpers marked ID2, ID1, and ID0. The jumper positions for each SCSI ID value is shown on the right side of the figure. A jumper installed represents a binary "1" and no jumper represents a "0". To access the jumpers, the drive must be removed from the enclosure.



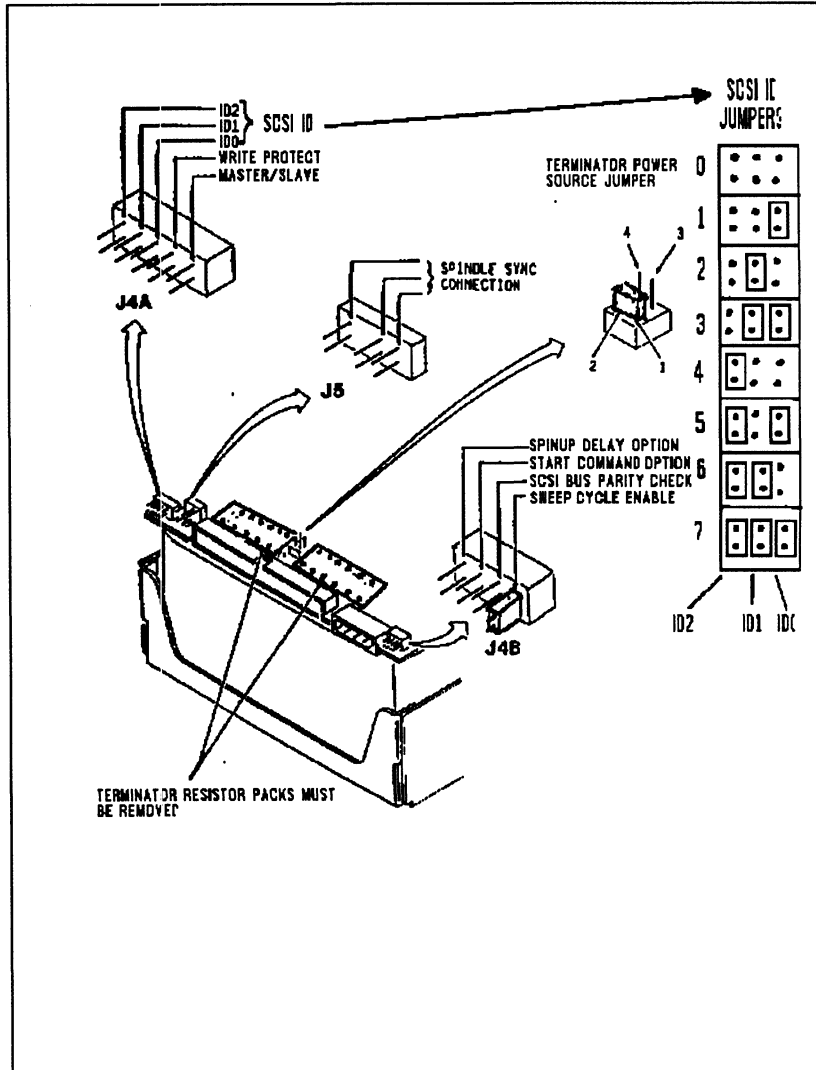

**Figure A.62**  
*Seagate ST41600N SCSI ID Jumpers*

**A.63 Sense Key  
Descriptions**

The following are the defined Sense Keys returned in byte 2 of the drive Extended Sense bytes, and in the upper byte of word 20 of the Control Block status returned from the controller.

**SENSE KEY (HEX) MEANING**

- 00 NO SENSE - There is no specific Sense Key information to report.
- 01 RECOVERED ERROR - The last command completed successfully with some recovery action performed by the drive.
- 02 NOT READY - The disk drive unit was not ready to accept a command.
- 03 MEDIUM ERROR - Indicates the command terminated with a non-recovered error condition which was probably caused by a flaw in the disk medium or an error in the recorded data.
- 04 HARDWARE ERROR - Indicates the drive encountered a non-recoverable hardware failure during operation or selftest. This includes SCSI bus parity errors.
- 05 ILLEGAL REQUEST - The drive received a command which contained an illegal parameter.
- 06 UNIT ATTENTION - This is used to indicate that the drive has been "reset" either by power down/up or a hard reset from the controller.
- 07 DATA PROTECT - Indicates a Write operation was attempted on a drive which was write-protected. Check the write protect jumper on the disk drive.

- 0B **ABORTED COMMAND** - Indicates an aborted operation occurred.
- 0D **VOLUME OVERFLOW** - Indicates the drive has reached end-of-medium, and that data remains in the drive buffer that has not been written to the disk.
- 0E Indicates the source data did not match the data read from the medium.

**A.7 Wang DAT  
1300 & 2000  
4mm DAT Tape  
Drives**

**A.71  
Specifications**

Recording Format . . . . . Helical Scan

Cartridge . . . . . 4mm Industry Standard

**Cartridge Sizes**

2000 . . . . . 3.7 GB - 5.7 GB

1300 . . . . . 1.3 GB - 2.0 GB

Error checking . . . . . Read after Write, Auto re-write

**Non-Recoverable**

Error Rate . . . . . less than one bit in 10<sup>5</sup> bits read

**Buffer**

2000 . . . . . 768KB

1300 . . . . . 512KB

Effective Head-to-Tape Speed . . . . . 3.133 m/sec(123ips)

**SCSI Bus Data Transfer Rates**

. . . . . DDS = 183K bytes/sec

. . . . . compression = 520K bytes/sec

***Environmental***

**Operating Environment:**

Temperature . . . . . +5 to +45°C

Relative Humidity . . . . . 20% to 80% (non-condensing)

Altitude . . . . . -200 to +10,000 feet

**Non-Operating Environment:**

Temperature . . . . . -30 to +60°C

Relative Humidity . . . . . 0% to 90% (non-condensing)

Altitude . . . . . -200 to +50,000 feet

Shoot page A29 & A30  
Separate!

cut &  
Use pasted page A29

TOO DARK OTHERWISE

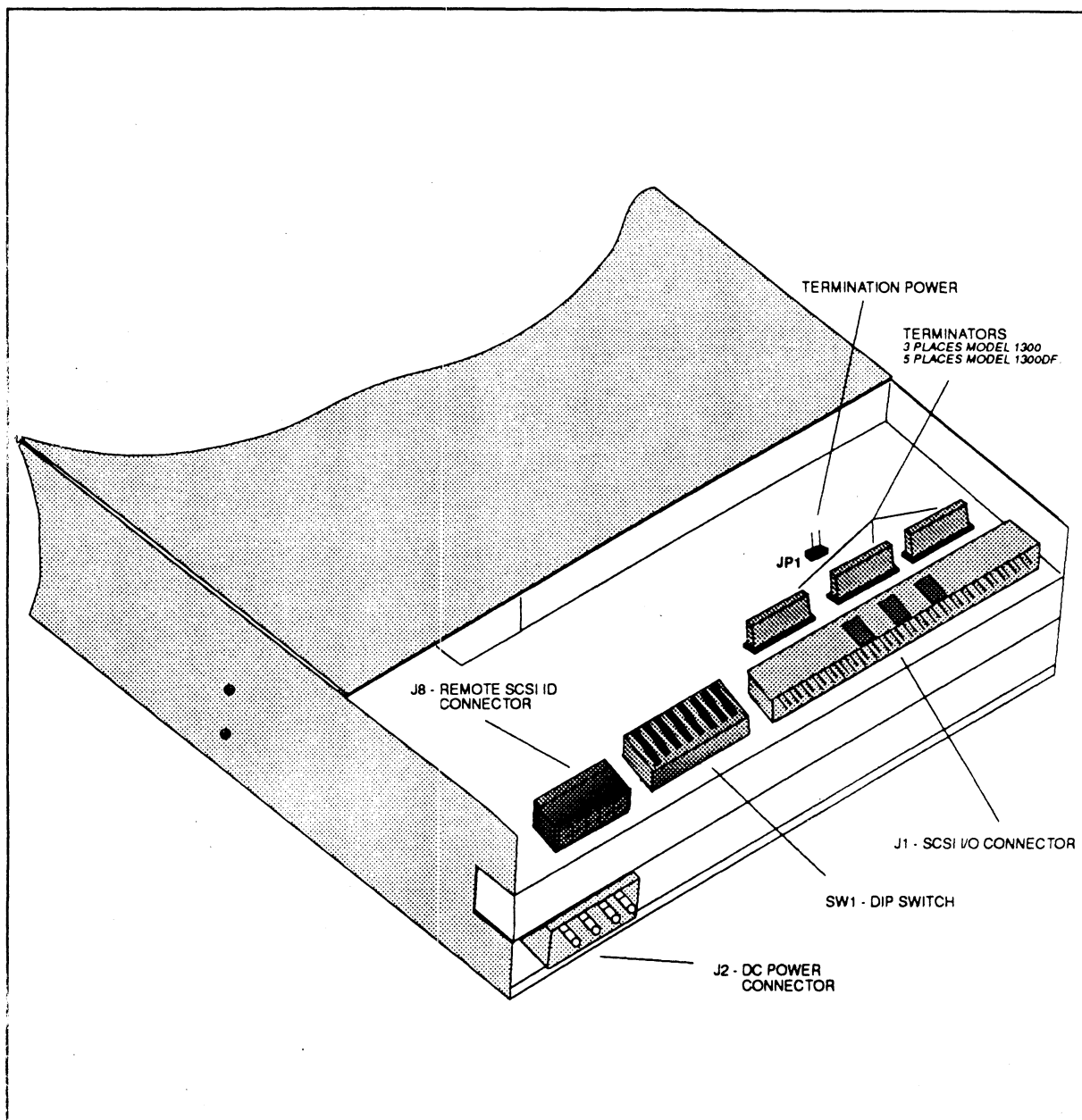

*Figure A.71a - Drive Connectors and Switches*

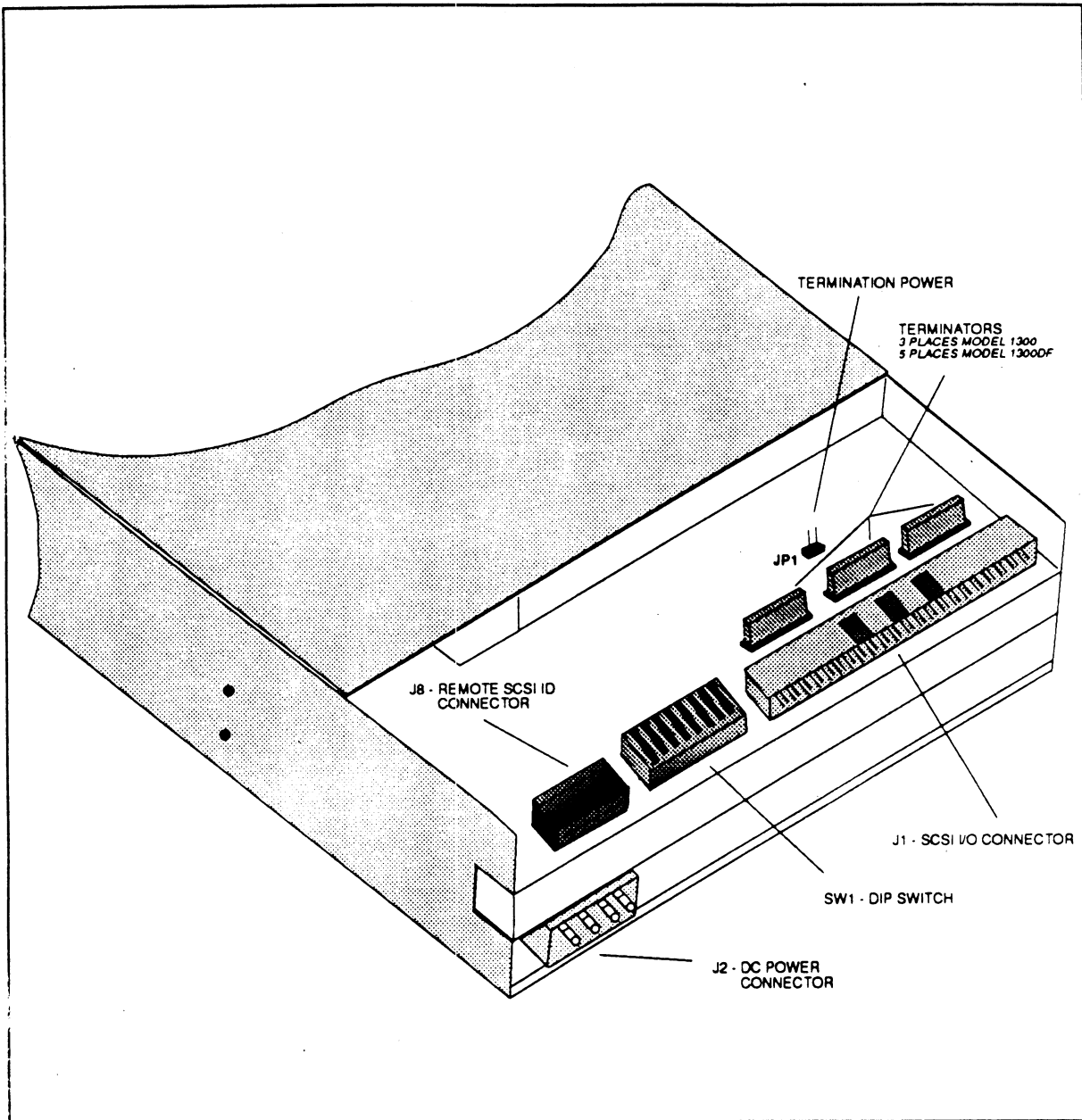

*Figure A.71a - Drive Connectors and Switches*

*SW1-6,7,8 SCSI  
Device ID  
Selection*

The following table provides switch settings and priority on the SCSI bus for the different SCSI ID settings.

**Switch settings for 2000 SCZ-4 and SCZ-5**

SW-1	SW1-2	SW1-3	SW1-4	SW1-5	SW1-6	SW1-7	SW1-8
OFF	OFF	ON	ON	ON	*	*	*

**Switch settings for 1300 SCZ-4 and SCZ-5**

SW-1	SW1-2	SW1-3	SW1-4	SW1-5	SW1-6	SW1-7	SW1-8
ON	ON	ON	ON	ON	*	*	*

\* See above chart

*Cassette*

The Model 1300 and 2000 uses the industry-standard 4mm Digital Audio Tape (DAT) Cassette.

**Write Protect**

The Cassette has a Write Protect feature to prevent recording over data on tape. Protection is invoked by sliding the Write Protect tab to open the window. A sensor in the drive detects the position of the tab and will not allow writing to tape if the tab is in the open position.

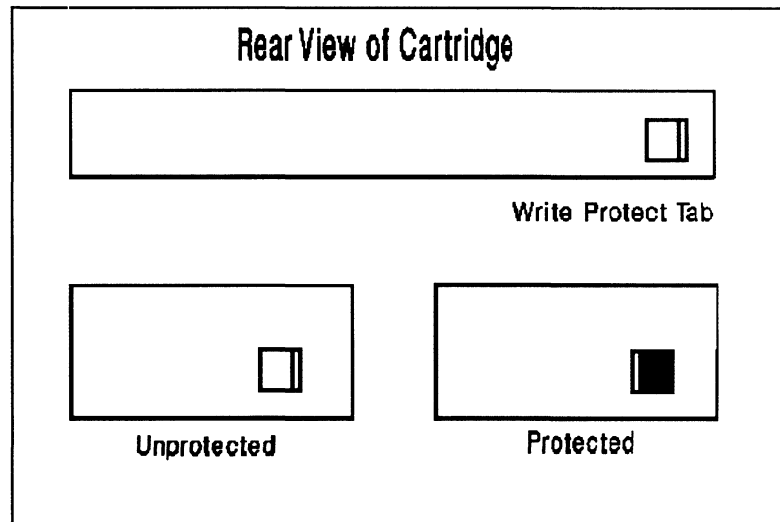

*Figure A.71 - 4mm DAT Cassette*



## Handling and Storage

As with any magnetic storage medium, the Cassette should be used and stored within the specified environment. Any deviation from the specified environment could result in data loss.

## Loading & Unloading

The Cassette is loaded in the drive by inserting it, label up, in the loading slot in the front of the drive. If the drive has DC power applied, the Cassette will be drawn into the mechanism and positioned for use. Do not force the cassette into the drive. See Front Panel.

The cassette is unloaded by pressing the eject button or by a SCSI unload command.

## *Sense Summary*

<b>Sense Key</b>	<b>Description</b>
0	No Sense
1	Recovered Error
2	Not Ready
3	Medium Error
4	Hardware Error
5	Illegal Request
6	Unit Attention
7	Data Protect
8	Blank Check
A	Copy Aborted
B	Aborted Command
D	Volum Overflow



# Appendix B

---

## Controller LEDs

There are a group of LEDs located along the front edge of the controller, visible when the computer front cover is removed. This section describes the meaning of the LEDs as viewed from left to right (component side of controller up).

**B.1 LED Indicators On SCZ-3 and SCZ-4 Controllers**

Figure B.1 shows the LEDs for SCZ-3 and SCZ-4 controllers.

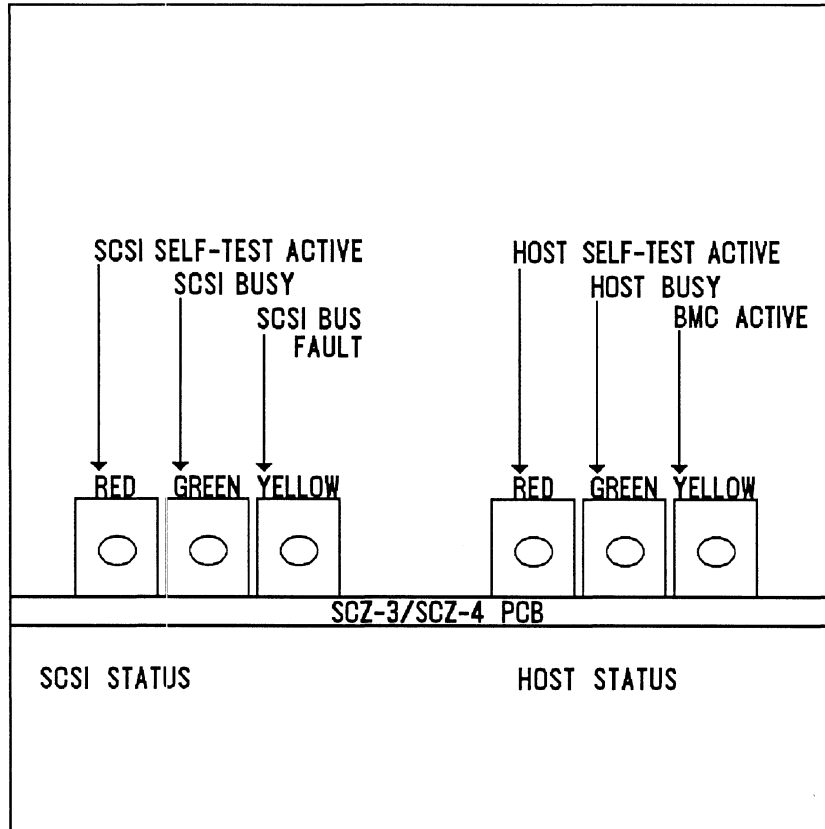

**Figure B.1**  
**SCZ-3 and SCZ-4 LED Status Indicators**

The left-most three LEDs indicate SCSI Processor status:

RED            SCSI Self-test

This LED turns ON to indicate SCSI Processor self-test is in progress. Upon successful completion of self-test at power-up, the LED should go OFF. If it does not go off within 30

seconds, or begins to flash along with the other 2 adjacent LEDs, self-test has failed. Refer to Chapter 3 of this manual for more information.

**GREEN**      **SCSI Bus Busy**

When ON, this LED indicates that the SCSI bus is BUSY, i.e., a device has control of the bus. This LED will be OFF during BUS FREE or DISCONNECT SCSI conditions. This means that although the SCSI Busy LED may be OFF, the disk and tape drives may still be performing operations such as format or head positioning, but are temporarily "disconnected" from the controller.

**YELLOW**      **SCSI Bus Fault**

Indicates an abnormal SCSI bus condition such as cable fault. Also used to flash self-test error codes.

The three right-most LEDs indicate Host Processor status:

RED Host Self-test

This LED turns ON to indicate Host Processor self-test is in progress. Upon successful completion of self-test at power-up, the LED should go OFF. If it does not go off within 30 seconds, or begins to flash, self-test has failed. Refer to Chapter 3 of this manual for more information.

This will also be ON when the Host Processor is in DEBUG mode. Debug mode is only used while running the controller utilities such as the Configurator program.

GREEN Controller Busy

This LED reflects the status of the Busy flag for the controller. An ON LED indicates the Busy flag is set.

Observing the Busy flag provides a means of monitoring controller/computer activity. When ON, an LED indicates that the controller is busy executing a PIO command. When an LED goes OFF, the controllers Busy flag has been cleared and it is ready to accept another command.

Note that this refers only to the processing of PIO commands, not Control Blocks. In other words, a controller whose Busy flag is not set may still be in process of executing a command. Refer to your programmer's reference for more information.

YELLOW BMC Active

Indicates that the BMC bus is actively transferring data between the controller and computer memory.

## B.2 LED Indicators On the SCZ-5 Controller

Figure B.2 shows the LEDs for the SCZ-5 controller.

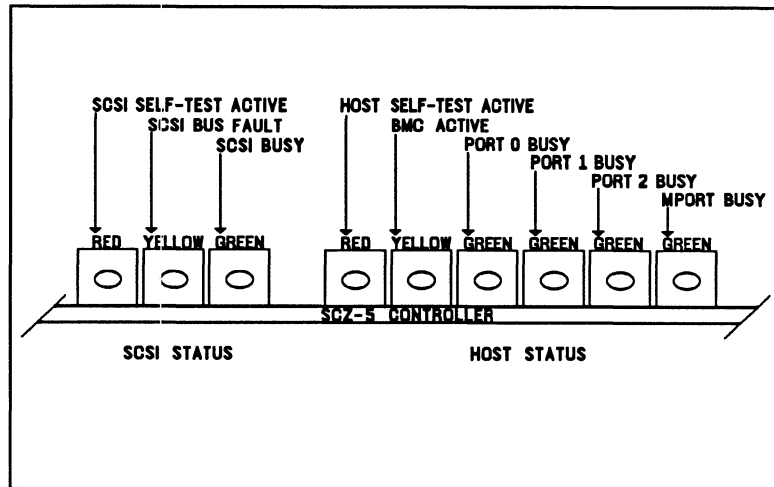

**Figure B.2**  
**SCZ-5 LED Status Indicators**

The left-most three LEDs indicate SCSI Processor status:

**RED** SCSI Self-test

This LED turns ON to indicate SCSI Processor self-test is in progress. Upon successful completion of self-test at power-up, the LED should go OFF. If it does not go off within 30 seconds, or begins to flash along with the other 2 adjacent LEDs, self-test has failed. Refer to Chapter 3 of this manual for more information.

**YELLOW** SCSI Bus Fault

Indicates an abnormal SCSI bus condition such as cable fault. Also used to flash self-test error codes.

**GREEN**      **SCSI Bus Busy**

When ON, this LED indicates that the SCSI bus is BUSY, i.e., a device has control of the bus. This LED will be OFF during BUS FREE or DISCONNECT SCSI conditions. This means that although the SCSI Busy LED may be OFF, the disk and tape drives may still be performing operations such as format or head positioning, but are temporarily "disconnected" from the controller.

The six right-most LEDs indicate Host Processor status:

**RED**            **Host Self-test**

This LED turns ON to indicate Host Processor self-test is in progress. Upon successful completion of self-test at power-up, the LED should go OFF. If it does not go off within 30 seconds, or begins to flash, self-test has failed. Refer to Chapter 3 of this manual for more information.

This will also be ON when the Host Processor is in DEBUG mode. Debug mode is only used while running the controller utilities such as the Configurator program.

**YELLOW**      **BMC Active**

Indicates that the BMC bus is actively transferring data between the controller and computer memory.



GREEN	Port 0 Busy (highest interrupt priority)_
GREEN	Port 1 Busy
GREEN	Port 2 Busy
GREEN	Maintenance Port (MPORT) Busy (lowest interrupt priority)

These four green LEDs show the status of the Busy flags for the four controller ports. An ON LED indicates the Busy flag is set.

Observing the Busy flag provides a means of monitoring controller/computer activity. When ON, an LED indicates that the port is busy executing a PIO command. When an LED goes OFF, the ports Busy flag has been cleared and the port is ready to accept another command.

Note that this refers only to the processing of PIO commands, not Control Blocks. In other words, a port whose Busy flag is not set may still be in process of executing a command. Refer to your programmer's reference for more information.

The disk and tape control sections of the controller will be assigned to either Port 0 or Port 1, depending on the configured setting of "Disk/Tape Interrupt Priority."

